

AMSTRAD

Personal Computer Word Processor

PCW8256/8512



<http://amstrad.cpc.free.fr>



User Guide - CP/M Logo & Word Processor Manual

DON'T SWITCH ON YET!

**YOU MUST READ THE INTRODUCTORY SECTION OF THIS MANUAL
BEFORE ATTEMPTING TO USE YOUR PCW.**

This manual covers both the PCW8256 and the PCW8512. It should be noted, therefore, that all references to '...the PCW8256' are equally applicable to the PCW8512.

The PCW8512 comes with the 2nd disc drive fitted as standard. In addition, the total memory is 512K (compared to 256K on the PCW8256). This extra memory is used on what's known as 'Drive M' (don't worry if that means nothing to you at the moment - it will be explained later) -so, where examples in the manual quote a certain amount of memory being available on 'Drive M' (for the PCW8256), you should bear in mind that there is approximately 256K extra memory (on top of the quoted figure) for the PCW8512.

Details about the use of a 2-drive system (whether it is a PCW8512, or a PCW8256 with a second drive (FD-2) fitted) will be found in Part III of this manual (towards the end).

After having set up the equipment and worked through the opening few chapters, you should be able to type in and print out a simple document. In that short time, you obviously won't have learnt how to use many of the features that LocoScript offers such as the selection of more elaborate typefaces, the setting up of margins within a document, or justification (making the left and right edges of the text line up). These, together with all of LocoScript's other features will be covered as you progress through the manual. **THERE IS NO SHORT CUT TO LEARNING LOCOSCRIPT - YOU MUST READ THE MANUAL.**

Now before you start setting up your PCW, don't forget to read the pages entitled 'Introduction' and 'About this Guide', a few pages ahead.

AMSOFT

A division of

AMSTRAD

CONSUMER ELECTRONICS PLC

The PCW8256 and PCW8512 User Guide
and Guide to Locomotive Software's LocoScript

<http://amstrad.cpc.free.fr>

© Copyright 1985 AMSOFT, AMSTRAD Consumer Electronics plc and
Locomotive Software Ltd

Neither the whole nor any part of the information contained herein, nor the product described in this manual may be adapted or reproduced in any material form except with the prior written approval of AMSTRAD Consumer Electronics plc ('AMSTRAD').

The product described in this manual and products for use with it are subject to continuous development and improvement. In particular, there may be differences between the messages displayed on your screen and those shown here.

All information of a technical nature and particulars of the product and its use (including the information and particulars in this manual) are given by AMSTRAD in good faith. However, it is acknowledged that there may be errors or omissions in this manual. A list of details of any amendments or revisions to this manual can be obtained by sending a stamped, self addressed envelope to AMSOFT Technical Enquiries. We ask that all users take care to submit their reply paid user registration and guarantee cards.

You are also advised to complete and send off your Digital Research User registration card.

AMSOFT welcomes comments and suggestions relating to the product or this manual.

All correspondence should be addressed to: **AMSOFT**
Brentwood House
169 Kings Road
Brentwood
Essex CM14 4EF

All maintenance and service on the product must be carried out by AMSOFT authorised dealers. Neither AMSOFT nor AMSTRAD can accept any liability whatsoever for any loss or damage caused by service or maintenance by unauthorised personnel. This manual is intended only to assist the reader in the use of the product, and therefore AMSOFT and AMSTRAD shall not be liable for any loss or damage whatsoever arising from the use of any information or particulars in, or any error or omission in, this manual or any incorrect use of the product.

Written by Jean Gilmour, Locomotive Software
Typeset by Interaction Systems Ltd
Published by AMSOFT

First Published 1985

Third Edition 1986

Dr. Logo, CP/M, CP/M Plus, GSX, DR Graph, CP/M-80, CCP/M-86 and MP/M-86 are trademarks of Digital Research Inc
Z80 is the trademark of Zilog Inc.

Z19, Z29 and H89 are trademarks of Zenith Data Systems Inc.

VT52 is a trademark of Digital Equipment Corp.

Mulard BASIC, Locomotive and LocoScript are trademarks of Locomotive Software Ltd

PCW8512, PCW8256, CPC6128, CPC664, CPC464 and DDI-1 are trademarks of AMSTRAD Consumer Electronics plc

AMSTRAD is a registered trademark of AMSTRAD Consumer Electronics plc

Any unauthorised use of the trademark or word AMSTRAD is strictly forbidden

Introduction

The PCW8256 is a word processor, which means that its main task is to help you prepare professional-looking letters and documents.

The PCW8256 is also a powerful personal computer, able to run a wide range of commercial software packages.

There are, of course, other personal computers that can be used as word processors. The advantage of the PCW8256 is that it has been designed side-by-side with Locomotive Software's LocoScript to provide a dedicated word processor that is particularly easy to use.

LocoScript guides you through the steps you need to take, not only to create documents and edit them, but also to get the best visual effect when you print them out.

It provides menus of options and facilities: you don't have to remember complicated abbreviations to get it to work. These work in the same way across the whole range of functions (and indeed in any other Loco- software you use).

The keystrokes that will bring you the required features are displayed as part of every screen display.

Feel free to explore LocoScript. The keys to experiment with are the function keys (...), the 'Set' and 'Clear' keys (and), the cursor keys and the 'Enter' key. If you decide not to follow anything through, just press the 'Cancel' key ()

The CP/M Plus operating system and the BASIC and LOGO computer languages have been provided for when you want to use the PCW8256 as a personal computer. Their use is covered in 'CP/M Plus for the PCW8256' and 'Guide to Mallard BASIC' (available from AMSOFT- price £ 5).

About this Guide

This User Guide starts by telling you how to set up the PCW8256.

The next section forms a 'Guide to LocoScript', describing how the features of Locomotive Software's LocoScript can be used to best advantage to generate the documents you require.

It also acts as a tutorial in word processing with LocoScript. How to use the menus is covered in detail at first but less so in later stages of the guide as you will be used to how they work by then.

We particularly recommend the section entitled 'Your first twenty minutes' which introduces you to word processing on the PCW8256.

Once you have worked through that, those of you who are already familiar with the way a word processor works need only ever treat this guide as a source of advice on how to approach particular types of document.

The final part is the reference section for when you are an experienced user.

Those of you for whom the PCW8256 is your first word processor are advised to work through a number of the following chapters. Sample texts are provided on Side 1 of the system discs supplied with your PCW8256 for you to practise on.

The LocoScript word processing system is subject to continual development and a number of enhancements may have been implemented since the preparation of the PCW8256 User Guide.

To allow for this, we may have included a special document called READ.ME on Side 1 of your system discs. If so, a message drawing your attention to this document will appear when you load LocoScript.

The READ.ME document will describe all the changes applicable to your version of LocoScript, but it may assume a general understanding of how LocoScript works. We suggest you postpone reading the READ.ME document until after you have worked through some of the stages of the Guide to LocoScript.

Attention is also drawn to the Important Notice printed at the end of the Guide to LocoScript.

CONTENTS

Chapter 1: Setting up	1
Chapter 2: Your first twenty minutes	11
Chapter 3: Keeping your work on disc	27
3.1 Discs for the PCW8256	27
3.1.1 How to handle discs	31
3.1.2 Loading and unloading discs	31
3.2 Making copies of discs	33
3.3 Organising your work	36
3.3.1 Keeping your filing system up to date	38
3.4 Managing your discs	39
3.4.1 The operations available	41
3.5 Preparing discs for use	45
3.5.1 Making a Start of Day disc	46
3.5.2 Making a Data disc	47
A Guide to LocoScript	51
Stage 1: Enhancing the text	55
Stage 2: Using the simpler editing keys	63
Stage 3: Setting out text	73
Stage 4: Refining the appearance of the text	87
Stage 5: Setting out pages	97
Stage 6: Headings and page numbers	105
Stage 7: Cutting and pasting	111
Stage 8: Printing	115
Stage 9: Eliminating keystrokes	121
Stage 10: Setting up a group template	125
LocoScript summarised	129

Appendix I: Troubleshooting **141**

**Appendix II: The printer:
Loading and maintenance** **145**

II.1	Paper for the printer	145
II.2	Autoloading the printer	145
II.3	Changing the ribbon	147
II.4	Adjusting the print head	147
II.5	General hints	148

**Appendix III: Using LocoScript
files in other programs** **149**

III.1	Making an ASCII file	149
III.2	File communication	150

Licence Agreement

Locomotive Software Licence Agreement

Setting up

The box in which your PCW8256 is supplied should contain the following:

- a PCW8256 Monitor Unit, with a green screen and fitted disc drive(s)
- a Keyboard
- a Printer with separate tractor feed and ribbon cable
- an ink ribbon
- two 3inch Compact Floppy Discs
- this Manual
- two paper tray extensions

Before you read any further, check that you have all these items.

Fitting the mains plug

The PCW8256 operates from a 220-240Volt 50Hz mains supply.

Fit a proper mains plug to the mains lead on the Monitor Unit. If a 13Amp (BS1363) plug is used, a 5Amp fuse must be fitted. The 13Amp fuse supplied in a new plug must not be used. If any other type of plug is used, a 5Amp fuse must be fitted either in the plug or in the adaptor or at the distribution board.

Important The wires in the mains lead are coloured in accordance with the following code:

Blue : **Neutral**
Brown : **Live**

As the colours of the wires in the mains lead of this apparatus may not correspond with the coloured markings identifying the terminals in your plug, proceed as follows:

The wire which is coloured **Blue** must be connected to the terminal which is marked with the letter '**N**' or coloured **black**.

The wire which is coloured **Brown** must be connected to the terminal which is marked with the letter '**L**' or coloured **red**.

DO NOT PLUG THE PCW8256 INTO THE MAINS SUPPLY YET

Disconnect the mains plug from the supply socket when not in use.

Do not attempt to remove any screws or to open the casing of the Monitor Unit. Always obey the warning on the rating label on the back of the Monitor Unit.

WARNING – LIVE PARTS INSIDE. DO NOT REMOVE ANY SCREWS

Connecting the keyboard and the printer

First check that the PCW8256 is not plugged into the mains supply.

Connect the keyboard to the Monitor Unit by inserting the 4-pin DIN plug on the end of the keyboard cable into the socket on the right hand side of the Monitor Unit.

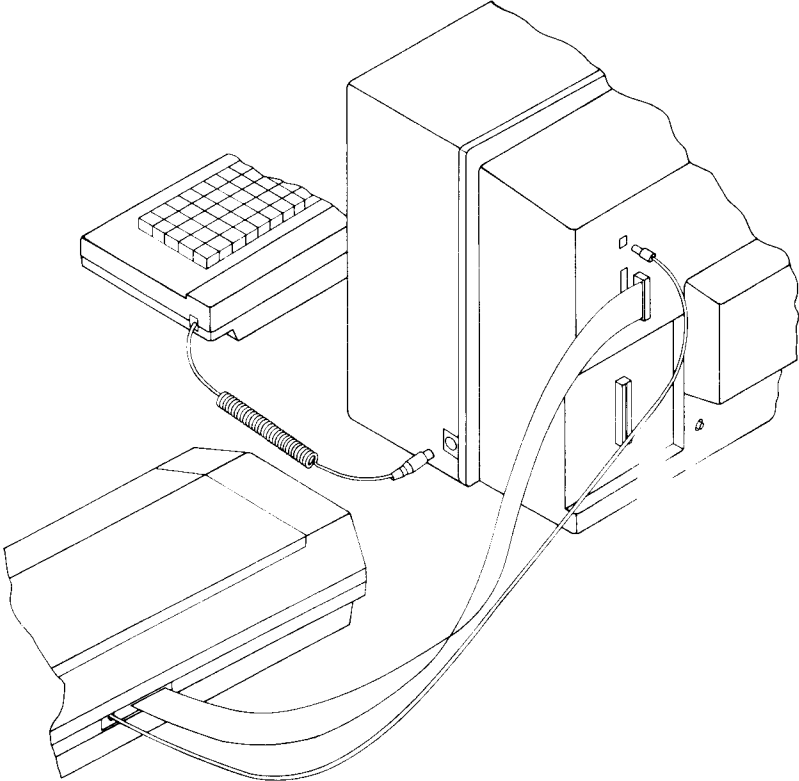

To connect the printer to the Monitor Unit, first insert the 34-way connector on the printer ribbon cable into the 34-way socket on the back of the Monitor Unit. Note that you will have to position your printer quite close to the Monitor Unit. Be careful not to stretch the ribbon cable.

Then insert the plug on the end of the printer's other cable into the Power Out socket on the back of the Monitor Unit.

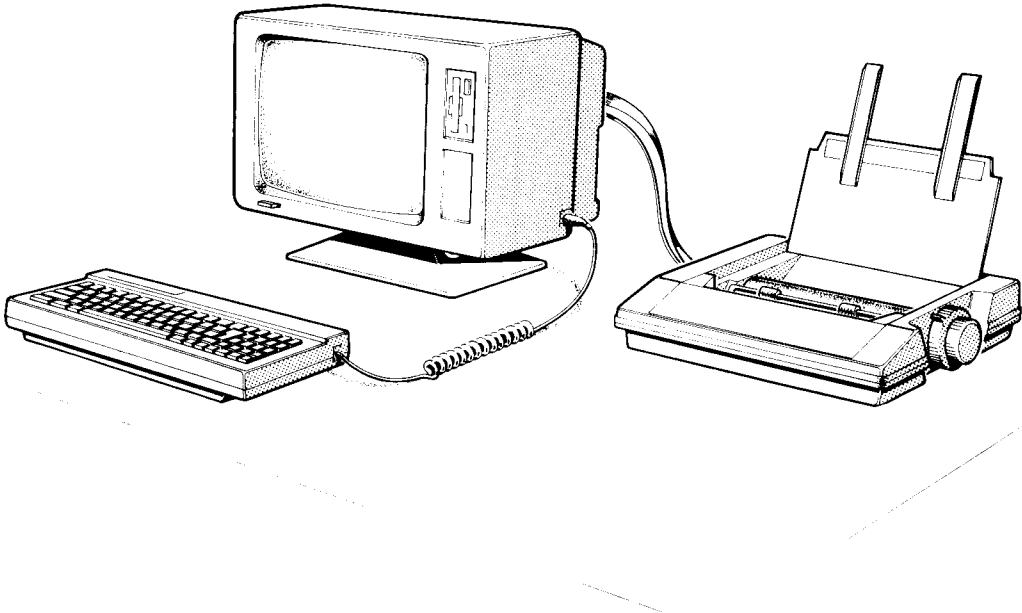

Do not attempt to load paper into the printer at this stage.

Switching on

Start with the mains plug out of the supply socket, the pushbutton power switch on the front of the Monitor Unit in its OFF position (fully released) and no disc in either disc drive.

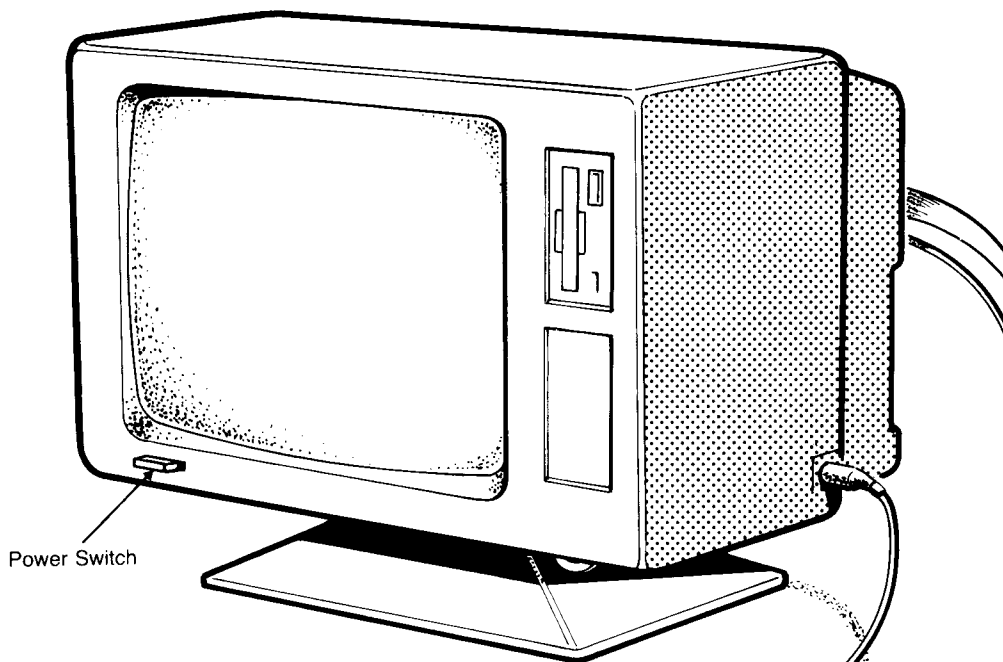

Plug the Monitor Unit into the mains supply; then turn the machine on by means of the power switch on the monitor. The monitor screen will come up bright green.

Select the system disc with Sides 1 and 2 on it.

Hold the disc by its labelled end, with Side 1 to the left. Now insert the disc into the drive slot until it clicks home.

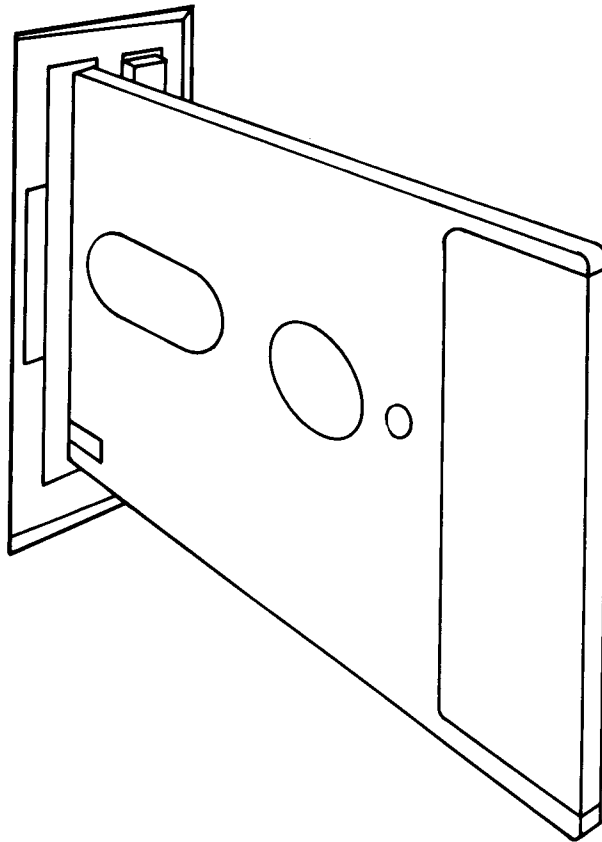

This should require no more than gentle pressure: if the drive appears to be resisting the disc, stop. Whatever you do, don't force it.

If you have problems, first check that you are putting the disc in the right way round. Then check that there isn't a disc already in the drive (press the Eject button). If you still have problems, consult your dealer.

The disc drive motor should now turn on. This is indicated both by activity on the screen and a gentle whirring noise. If it doesn't, **press the Space Bar**. The computer then starts to read your disc.

If all is well, you will see a pattern of green and black horizontal lines on the screen for a short while. The screen then clears before displaying:

AMSTRAD PCW8256 Personal Computer Word Processor

Locomotive Software's LocoScript v 1.20

© 1985 Locomotive Software Ltd. & Amstrad Consumer Electronics plc

for a short while.

If you have put the disc in the wrong way round, you will see a message starting 'PCW8256 CP/M Plus...' Press the Eject button, put the disc in again the other way round, and press the [EXIT] key while holding down the [SHIFT] and [EXTRA] keys.

If you have accidentally inserted a disc designed to run on a different machine, the PCW8256 will detect this, bleep and switch the disc drive motor off. Check that you picked up the disc you intended.

If, on the other hand, the disc you selected is damaged in some way, the screen will flash as the PCW8256 tries to read it. After a few unsuccessful attempts, the computer will again bleep before switching the disc drive motor off.

In either of these cases, release the disc from the drive, using the Eject button, and then withdraw it completely. Check that it is the right disc and then re-insert it in the drive. Finally press the space bar.

Shortly after the first set of messages, the screen displayed should change to:

Disc management.				Printer idle. Using none.			
C=Create new document		E=Edit existing document		P=Print document		D=Direct printing	
f1=Disc change		f2=Inspect		f3=Copy		f4=Move	
f5=Rename		f6=Erace		f7=Modes		f8=Options	
Drive A: LOCOSCRP.V1		Drive B: not fitted		Drive M: LOCOSCRP.V1			
124k used 49k free 25 files		0k used 0k free 0 files		2k used 100k free 2 files			
ADVERTS 4k	group 4	0k		LETTERS 1k	group 4	0k	
SAMPLES 12k	group 5	0k		SAMPLES 0k	group 5	0k	
CONT 1k	group 6	0k		CONT 1k	group 6	0k	
TEMPLATE 17k	group 7	0k		TEMPLATE 0k	group 7	0k	
A:LETTERS 7 files		A:SAMPLES 5 files		A:CONT 1 files		A:TEMPLATE 12 files	
0 limbo files		0 limbo files		0 limbo files		0 limbo files	
PHRASES.SID 1k		ADVERT .EG 1k		TEMPLATE.STD 1k		LET2PAGE.HDP 2k	
READ .ME 6k		DOCUMENT.EG 4k				LET2PAGE.PLP 2k	
TEMPLATE.STD 1k		LAYOUT .EG 1k				LETTER .HDP 1k	
4 hidden 86k		QUOTE .EG 3k				LETTER .PLP 1k	
		TEXT .EG 3k				MANUSCRP. 2k	
						MEMO 2k	
						PAGENUM .CEN 1k	
						PAGENUM .PR 1k	
						PAGENUM .RJ 1k	
						PHRASES.LET 1k	
						PHRASES.NUL 1k	
						TEMPLATE.LAB 2k	

Adjust the brightness of this screen to a comfortable level by turning the Brightness thumbwheel on the front of the Monitor Unit.

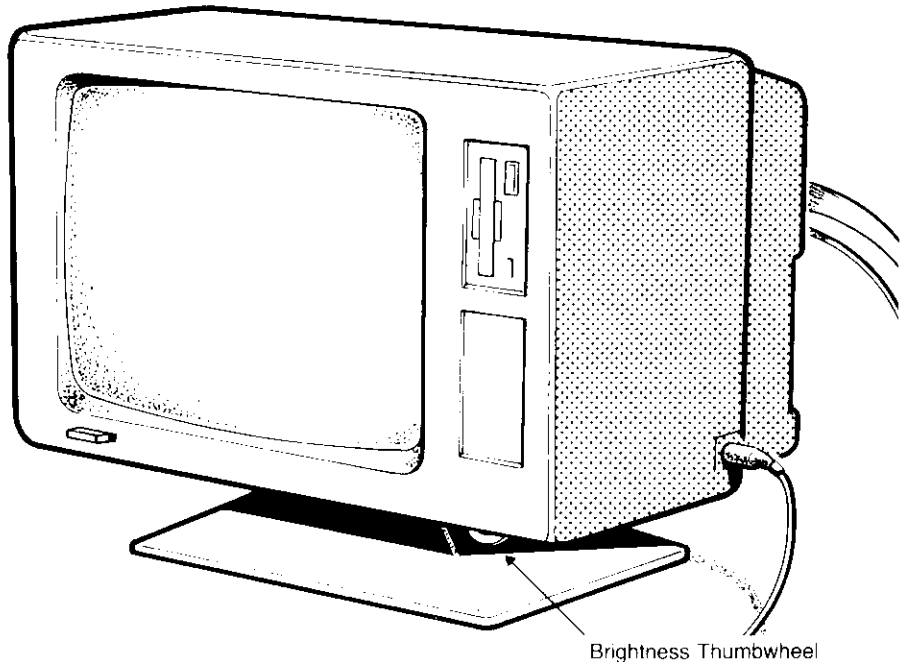

Brightness Thumbwheel

If necessary, also adjust the Vertical Hold (V-Hold) knob on the back of the unit until the display is steady and correctly positioned on the screen.

The PCW8256 is now ready for use as a word processor.

If you don't want to go on immediately to working with the word processor, press the Eject button on the disc drive to release the disc and then turn the PCW8256 off by pressing the power button.

ALWAYS REMEMBER TO REMOVE YOUR DISCS FROM THE DISC DRIVE(S) BEFORE YOU SWITCH OFF

Cleaning

We recommend the use of aerosol anti-static foam cleaners to clean both the screen and the plastic case. **Under no circumstances should spirit-based cleaners be used.**

The PCW8256 keyboard

The main keyboard

The lower character on any key is typed in by simply pressing that key. The upper character is typed in by pressing the **[SHIFT]** key at the same time. If you press the **[SHIFT LOCK]** key, every key you press will produce only the upper character until you press **[SHIFT LOCK]** again.

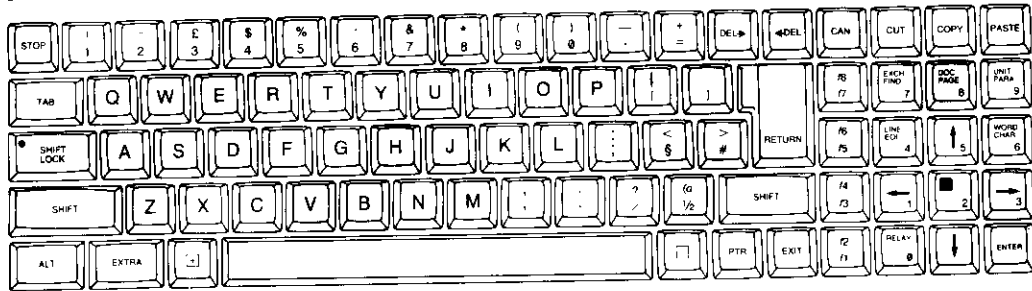

The keyboard with ALT

The lower character on any key is typed in by pressing that key and the **[ALT]** key (highlighted) simultaneously. The upper characters are typed in by pressing the **[SHIFT]** key as well.

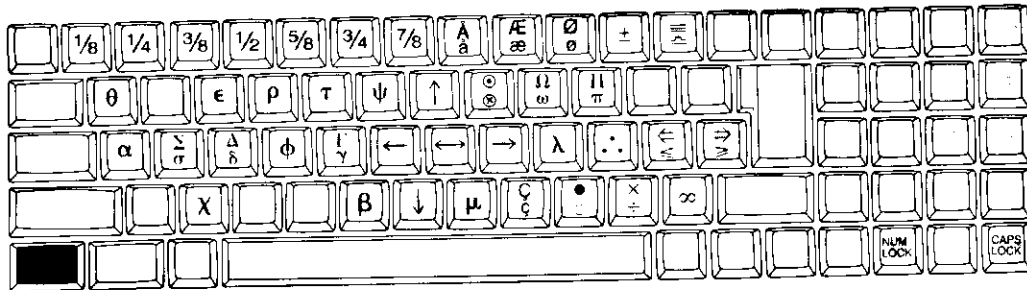

The keyboard with EXTRA

The character shown on any key is typed in by pressing it and the **[EXTRA]** key simultaneously.

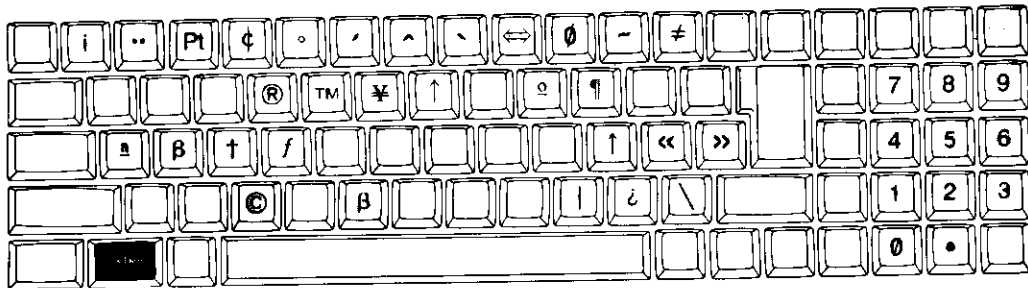

Special key combinations

[ALT] + **[ENTER]** acts as a Caps Lock key, setting/clearing the conversion of all lower case characters (little letters), except Greek characters, to their upper case (capital) counterpart.

[ALT] + **[RELAY]** acts as a Num Lock key, setting/clearing the use of a group of special keys as a numeric keypad.

[SHIFT] + **[EXTRA]** + **[EXIT]** resets the computer.

Your first twenty minutes

In this section, we will show you how to use Locomotive Software's LocoScript to prepare a simple one-page letter and then print it out on your printer. This will get you accustomed to the way LocoScript works.

If you haven't just worked through the previous section, turn back to that section and follow the instructions for turning on your PCW8256 and loading LocoScript from Side 1 of your system discs.

Your screen should now look like this:

Disc management.				Printer idle. Using none.			
C=Create new document				E=Edit existing document			
P=Print document				D=Direct printing			
f1-Disc change		f2-Inspect		f3-Copy		f4-Move	
f5-Rename		f6-Erase		f7-Modes		f8-Options	
Drive A: LOCOSCRP.U1		Drive B: not fitted		Drive M: LOCOSCRP.U1			
124k used 49k free 25 files		0k used 0k free 0 files		2k used 100k free 2 files			
PHRASES 54k	group 4	0k		LETTERS 1k	group 4	0k	
SAMPLES 12k	group 5	0k		SAMPLES 0k	group 5	0k	
CONT 1k	group 6	0k		CONT 1k	group 6	0k	
TEMPLATE 17k	group 7	0k		TEMPLATE 0k	group 7	0k	
A:LETTERS 7 files		A:SAMPLES 5 files		A:CONT 1 files		A:TEMPLATE 12 files	
0 limbo files		0 limbo files		0 limbo files		0 limbo files	
PHRASES.STD 1k		ADVERT .EG 1k		TEMPLATE.STD 1k		LET2PAGE.HDP 2k	
READ.ME 8k		DOCUMENT.EG 4k				LET2PAGE.PLP 2k	
TEMPLATE.STD 1k		LAYOUT .EG 1k				LETTER .HDP 1k	
4 hidden 86k		QUOTE .EG 3k				LETTER .PLP 1k	
		TEXT .EG 3k				MANUSCRP. 2k	
						MEMO 2k	
						PAGENUM .GEN 1k	
						PAGENUM .PR 1k	
						PAGENUM .RJ 1k	
						PHRASES .LET 1k	
						PHRASES .NUL 1k	
						TEMPLATE.LAB 2k	

The top two lines show you all the different types of operation you could do now, together with the key that you should press to select that particular operation. They tell you, for example, that if you want to create a new document such as a letter or a report, you should press the **C** key.

The exercise we have chosen for this introduction is writing a letter to someone called Fred. The first thing we have to do is to tell LocoScript that we want to create a new document – so press **C**

Before LocoScript can offer you a new document, it needs to know a bit more about the document you want to create. So a 'menu' of further information pops up on the screen.

Disc management		Printer file		Using A:	
C=Create new document		E=Edit existing document		P=Print document	
D=Direct printing		f1=Disc change		f2=Inspect	
f3=Copy		f4=Move		f5=Rename	
f6=Erase		f7=Modes		f8=Options	

Drive A: LOCOSCRP.V1 124k used 49k free 25 files	<table border="1"> <tr><th colspan="2">Create document</th></tr> <tr><td>Name:</td><td>DOCUMENT.000</td></tr> <tr><td>Group:</td><td>LETTERS</td></tr> <tr><td>Drive:</td><td>A</td></tr> </table>	Create document		Name:	DOCUMENT.000	Group:	LETTERS	Drive:	A	Drive M: LOCOSCRP.V1 2k used 100k free 2 files
Create document										
Name:	DOCUMENT.000									
Group:	LETTERS									
Drive:	A									
LETTERS 94k group 4 0k	LETTERS 1k group 4 0k	SAMPLES 12k group 5 0k								
CONT 1k group 6 0k	SAMPLES 0k group 5 0k	CONT 1k group 6 0k								
TEMPLATE 17k group 7 0k	TEMPLATE 0k group 7 0k	CONT 1k group 6 0k								
TEMPLATE 17k group 7 0k	CONT 1k group 6 0k	TEMPLATE 0k group 7 0k								

A:LETTERS 7 files 0 limbo files	A:SAMPLES 5 files 0 limbo files	A:CONT 1 files 0 limbo files	A:TEMPLATE 12 files 0 limbo files
PHRASES.SID 1k	ADVERT .EG 1k	TEMPLATE.STD 1k	LET2PAGE.HDP 2k
READ .ME 6k	DOCUMENT.EG 4k		LET2PAGE.PLP 2k
TEMPLATE.STD 1k	LAYOUT .EG 1k		LETTER .HDP 1k
4 hidden 86k	QUOTE .EG 3k		LETTER .PLP 1k
	TEXT .EG 3k		MANUSCRP. 2k
			MEMO 2k
			PAGENUM .CEN 1k
			PAGENUM .PR 1k
			PAGENUM .RJ 1k
			PHRASES .LET 1k
			PHRASES .NUL 1k
			TEMPLATE.LAB 2k

This suggests that you might store your letter when you have finished it as a document called DOCUMENT.000 in the LETTERS part of your disc.

We won't actually store this letter on your disc this time, so to a great extent these details are irrelevant – but it does mean that LocoScript will give you a rough outline of a letter on which to work.

As a general rule, you don't have to take LocoScript's choice of name. After all, DOCUMENT.000 is unlikely to remind you of what the letter is about. It would be a lot better if it was called FRED.PCW because it is going to be a letter to your friend Fred about your new PCW8256.

You can, in fact, choose any name for this document, provided the first part (before the dot) is no more than eight letters and digits and the second (after the dot) no more than three.

As you will have noticed, the line Name: DOCUMENT.000 is highlighted. This indicates that any characters you type in now will replace the letters of DOCUMENT.000. Type in:

FRED.PCW

and watch this work.

As we're happy with this new name, we will now move on to the next stage by pressing the [ENTER] key.

This will normally move you directly on to the next stage but in this particular instance, because you are working with one of the discs supplied with the PCW8256, you will see another menu pop up.

For now, don't worry about what this menu is telling you: just press the [ENTER] key. This tells LocoScript that you accept what it proposes.

The screen now changes completely to this:

```
6 FILENAMES/DOCUMENT.000 Editing text. Printer idle, Using A:
-Layout -P112 -LS1 -LFb Page 1 line 1 of 54
f1=Show f2=Layout f3=Emphasis f4=Style f5=Lines f6=Pages f7=Modes f8=Blocks EXIT
-----
| | | | |
| | | | | your address?
| | | | |
| | | | | date?
| | | | |
| | | | | addressee?
| | | | |
| | | | | Dear
-----
```

The best way of explaining this screen is by drawing a direct analogy with a typewriter.

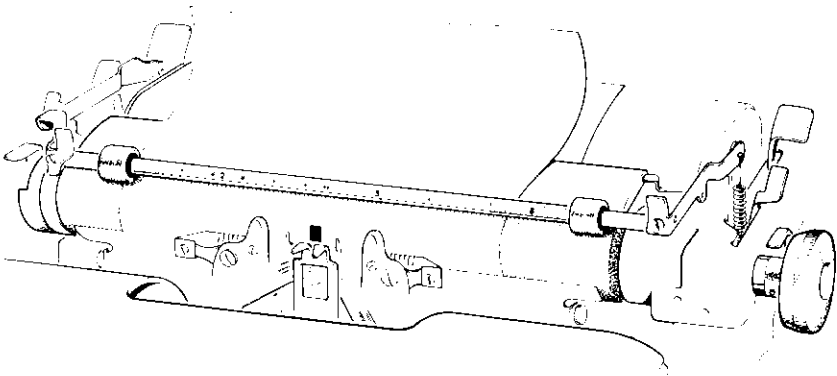

The first thing you will notice is that you have the top of the letter already sketched out for you. We will show you how to take advantage of this shortly.

The Ruler line immediately above this is marked out ready to count characters and shows you where the left and right margins are. The other symbols on the line tell you where the 'carriage' will move to as you press the TAB key, ie. they show where the TAB Stops are.

The oblong is called the cursor. This marks the current typing position.

All these features have some sort of parallel in a standard manual typewriter. The only real exceptions are the information lines at the top of your screen and the broken line across your page.

The information lines tell you about the typeface that will be used when you print out this letter and how it will be laid out. The broken line is used to tell you whereabouts you are in the letter, as we shall explain later.

How to change any of this will be described in a later section of this guide. The present settings will serve our purpose very well here.

The first thing we want to do is to type in Fred after the Dear you already have on the screen. (We shall come back to the various addresses and the date later.)

When you type anything in at the keyboard, this will appear where the cursor is and so we have to start by getting the cursor in the right place.

You move about your piece of 'electronic' paper by pressing the four Cursor keys.

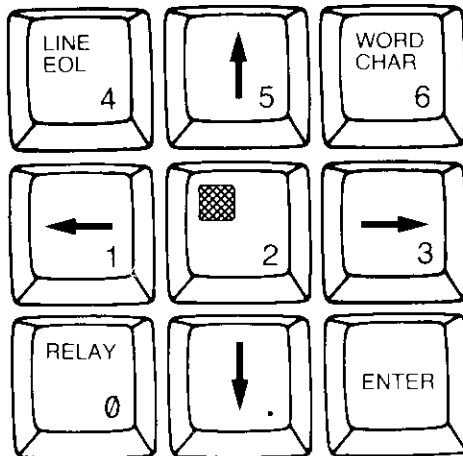

You can use these keys to move the cursor anywhere you like on the screen.

For now, press the Down Cursor ([↓]) until the cursor is over the D of Dear. Don't worry if you overshoot: just press the Up Cursor ([↑]) to get back to the right place.

Then press the Right Cursor ([→]) until the cursor is just to the right of the r. (Use the Left Cursor ([←]) to get back if you overshoot.)

Next type:

Fred

If you made any mistakes in typing this, use the [←DEL] key to rub out characters back to the place you made the mistake and then type the remaining characters in again. But be careful just to press the [←DEL] key, not to hold it down, or you will find rather more being rubbed out than you expected. This key is one of a number of keys on the PCW8256 to 'Auto-repeat'.

As you type, you will see the cursor moving to the right. A similar cursor on the Ruler line (the Ruler cursor) also moves to the right, thus giving you a constant measure of how far along the current line the next character you type will appear.

You now want to move onto the next line, so press [RETURN]

You will notice that, as well as moving the cursor to the beginning of the next line, there is now a special character, ¶, immediately after the 'd' of Fred.

```
1 2 3 4 5 6 7 8
↓
your address
date
addressee
Dear Fred ¶
```

This character, wherever it appears on the screen, always indicates that you want to start a new line here both now and when you print your document out. The character itself will not be printed.

If you want to leave a line blank, you just press [RETURN] when the cursor is at the beginning of the line.

Say, for example, that you decide you would like to leave two blank lines after 'Dear Fred' before starting the first paragraph of your letter. To do this, just press [RETURN] twice more.

You should now have two more of these special characters on your screen – one below the other – and the cursor should now be immediately below them.

Now watch carefully what happens as you type 'Electronics' letter by letter. As you reach the letter 'o', that part of the screen will seem to flash and suddenly all the letters 'Electro' will be at the beginning of the next line.

```
I've just bought a special kind of computer from Amstrad Consumer Electr█
```

```
I've just bought a special kind of computer from Amstrad Consumer  
Electro█
```

```
I've just bought a special kind of computer from Amstrad Consumer  
Electronics called a word processor and it's really clever.█
```

What has happened is that LocoScript has picked up that you won't get the full word 'Electronics' on the top line without breaking into the right margin. So it has started a new line for you.

This feature, which is called Word Wrap, means that you need never worry about where to start the next line in any paragraph you type in. LocoScript takes care of this for you.

The only time you have to press the Return key is to signal to LocoScript that you have come to the end of the paragraph.

If you now type the rest of the paragraph, you will see Word Wrap work for you again when you reach the word 'think'.

We now want to add another paragraph to the letter – one with mistakes in it, so that we can demonstrate how to correct these.

You can either type in some text of your own and discover from the description below how to correct any mistakes you make, or you can insert the piece of text we have set up for you. Use the Return key to put in a blank line below the paragraph you have just typed and then insert this text by pressing the **[PASTE]** key and then typing the letter Z.

Now press the [DEL>] key: this deletes the 'n'.

```
The conputer is called the PCW8256 and it runs LocoScript, which is
simple to use. This is my first letter. It only tookk me about
twenty minutes to get it free of spelling and laid out the the way I
wanted.␣
```

All that is left to do now, is just to type an 'm' and there on the screen is the word 'computer'.

```
The comnputer is called the PCW8256 and it runs LocoScript, which is
simple to use. This is my first letter. It only tookk me about
twenty minutes to get it free of spelling and laid out the the way I
wanted.␣
```

The next error you spot is 'tookk' on the second line of this paragraph.

Once again, use the four cursor keys to position the cursor over one of the 'k's (it doesn't matter which one you choose) and then press the [DEL>] key. This deletes the character under the cursor, giving you 'took' instead of 'tookk'.

```
The computer is called the PCW8256 and it runs LocoScript, which is
simple to use. This is my first letter. It only took me about
twenty minutes to get it free of spelling and laid out the the way I
wanted.␣
```

It has also made this line relatively short, spoiling the look of the paragraph. So the next thing to do is to ask LocoScript to set out this paragraph afresh - ie. relay it. You do this by pressing the [RELAY] key.

```
The computer is called the PCW8256 and it runs LocoScript, which is
simple to use. This is my first letter. It only took me about twenty
minutes to get it free of spelling and laid out the the way I wanted.␣
```

The effect of this is that LocoScript will check the layout of all the text up to the end of the paragraph you are working on, moving any words it can back from the beginning of one line to the end of the previous line. In this case, LocoScript decides that there is now room for the word 'twenty' on the previous line and adjusts the rest of the paragraph accordingly.

The cursor, you will see, is still at the end of the word 'took'.

Now you notice that you should have 'spelling mistakes', not just 'spelling' on the third line.

This time, move the cursor to the space following the word 'spelling' and type in ' mistakes'. As you type, you will see the text to the right of where you are typing, moving right.

The computer is called the PCW8256 and it runs LocoScript, which is simple to use. This is my first letter. It only took me about twenty minutes to get it free of spelling mistakes and laid out the the way I wanted.

Suddenly, as the end of the line hits the right margin, the line splits into two halves. LocoScript has given you a new line to work on.

When you have finished, just press the [RELAY] key. The two parts of the paragraph will close up as LocoScript relays the rest of the paragraph.

The next thing to correct is the duplication of the word 'the', also on the third line of this second paragraph.

The computer is called the PCW8256 and it runs LocoScript, which is simple to use. This is my first letter. It only took me about twenty minutes to get it free of spelling mistakes and laid out the the way I wanted.

You have two choices here: you can either position the cursor on the 't' of either 'the', and press [DEL] four times to get rid of the redundant 'the'; or you can position it in the space after one of the 'the's and press [←DEL] four times to get exactly the same effect.

As the characters are removed, the rest of the line moves left to fill up the gap.

This is again quite a big change, so press the Relay key when you are ready.

The computer is called the PCW8256 and it runs LocoScript, which is simple to use. This is my first letter. It only took me about twenty minutes to get it free of spelling mistakes and laid out the way I wanted.

That's got the second paragraph corrected.

Assuming the first paragraph is correct, all that's left to do now is to add your address at the top and the 'Yours sincerely' at the bottom.

The 'Yours sincerely' is the easier one to do first.

Press the [PAGE] key once. This moves the cursor to the bottom of your text, ie. next to the left margin on the line below the last one you typed.

```

-----?..?..?..?..?-----5-----?-----!-----
→  →  →  →  →  →
→  →  →  →  →  →
→  →  →  →  →  →
↓
↓
↓
→  →  →  →  →  →
↓
↓
↓
addressee
↓

```

21 Villiers Crescent
Ream'sford
Surrey
date

Now move the cursor to the carriage return symbol to the right of date and use the [DEL] key to 'rub-out' this marker word. Now type in today's date – this time you don't need to press [RETURN].

Next, move the cursor to the carriage return symbol after the word addressee and rub out this word as before. Type Fred in its place (or leave the line blank, if you prefer).

Finally, check the letter over for mistakes and then, when you are sure you are happy with it, press the [EXIT] key.

LocoScript responds with another of its pop-up menus. This one asks you to select from the options 'Finish editing', 'Save and Continue', 'Save and Print' and 'Abandon edit'.

```

f1=Show f2=Layout f3=Emphasis f4=Style f5=Lines f6=Pages f7=Modes f8=Blocks 2701
-----?..?..?..?..?-----5-----?-----!-----
→  →  →  →  →  →
→  →  →  →  →  →
→  →  →  →  →  →
↓
↓
↓
→  →  →  →  →  →
↓
↓
↓
Fred
↓
↓
↓
Dear Fred
↓
↓
↓
I've just bought a special kind of computer from Amstrad Consumer
Electronics called a word processor and it's really clever. I don't
think I'll ever want to use a typewriter again.
↓
↓
↓
The computer is called the PCW8256 and it runs LocoScript, which is
simple to use. This is my first letter. It only took me about twenty
minutes to get it free of spelling mistakes and laid out the way I
wanted.
↓
↓
↓
Yours sincerely
↓
↓
↓
Chris

```

Exit options:

Finish editing

Save and Continue

Save and Print

Abandon edit

21 Villiers
Ream'sford
Surrey
20 Sept 19

The way you make your selection is by moving the highlighting over the option you want with the aid of the Up and Down Cursor keys.

The option you want here is 'Save and Print', so press the Down Cursor key twice. As you will see, the highlighting is now over the 'Save and Print' option.

To tell LocoScript that this is the option you want, press the **[ENTER]** key.

(For your future reference, please note that if you wish to print only a certain number of pages out of a multi-page document, you should select the **Finish** editing option from the above menu, press **[ENTER]**, and then press **P**. The **Print** document menu will then give you the option to either **Print all pages** or **Print some pages**. This facility is explained on page 120.)

The next job is to put a sheet of paper in the printer.

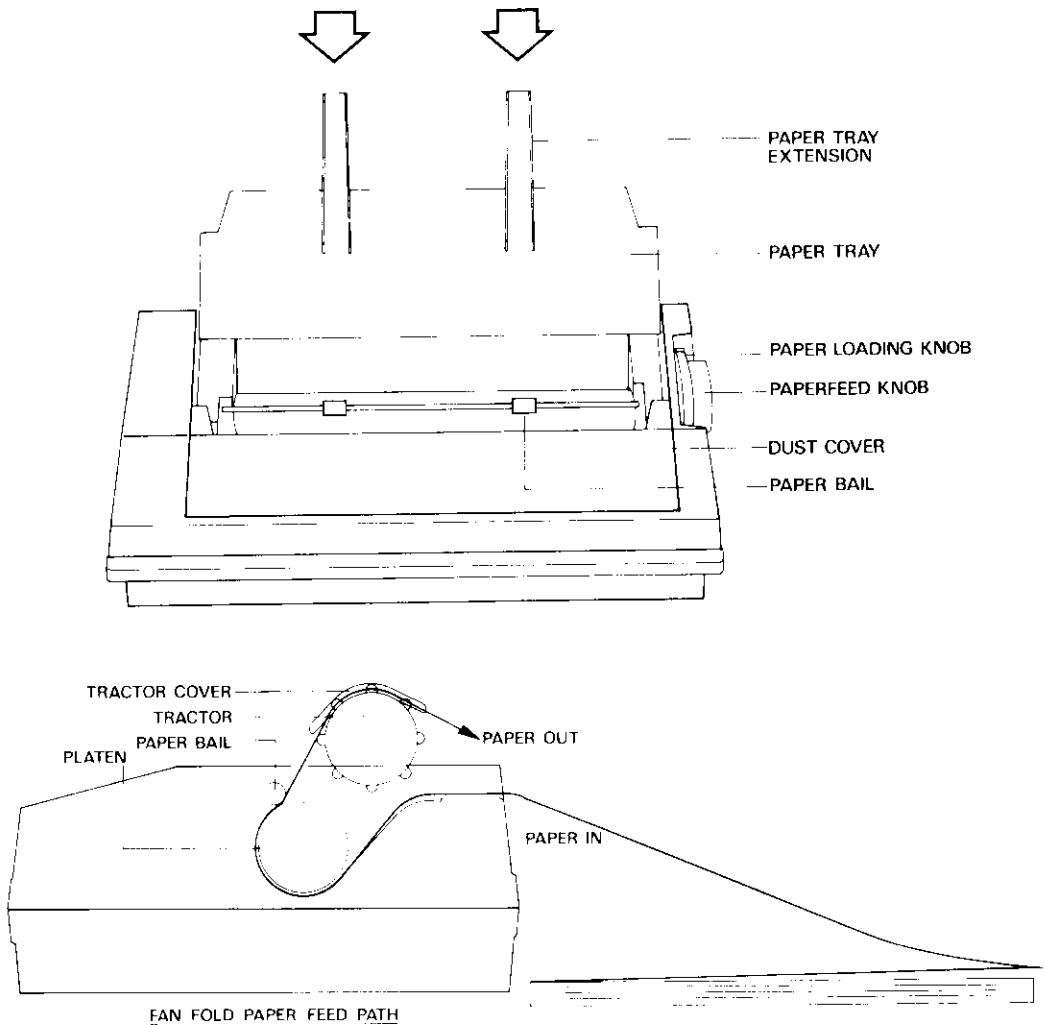

Take one sheet of A4 paper and lay it approximately centrally in the paper guide to the rear of the printer. This puts the paper in the right position ready for feeding into the printer.

Next turn the Paper Loading Knob one quarter of a turn towards you. The bail bar also moves forward.

The printer itself now feeds the paper in, leaving it placed exactly right for the start of your letter.

Turn the Knob back to its original position. This puts the bail bar back too.

If the paper needs any further adjustment, you can do this now.

Then turn back to your screen. You will notice that some of the screen messages have changed while you were loading the printer.

The new messages can be ignored at this stage. All you need to do is to press the Exit key.

The printer will now print out your letter to Fred, leaving it barely held by the Bail Bar. You can just lift the letter out.

Postscript

That's given you an introduction to the way LocoScript works.

Feel free to experiment with the way LocoScript works. You can't damage LocoScript by just using it.

Press any keys you like – though you will find the 'Set' and 'Clear' keys ([**T**] and [**_**]), the function keys ([**f1**] ... [**f8**]), and [**ENTER**] the most rewarding. For example, press **E** (for Edit) and try out the effects of the function keys on the letter you have just prepared.

If you want to get out of a menu without doing anything, just press [**CAN**] (for 'Cancel').

We've taken a number of shortcuts so that you could get going quickly. The next chapter takes a more detailed look at what you have been doing and shows you how to save your work for printing out another time.

If you don't want to go on to that straight away, press the Eject button on the disc drive and withdraw your disc.

Only then switch off by pressing the power button on the front of the Monitor Unit.

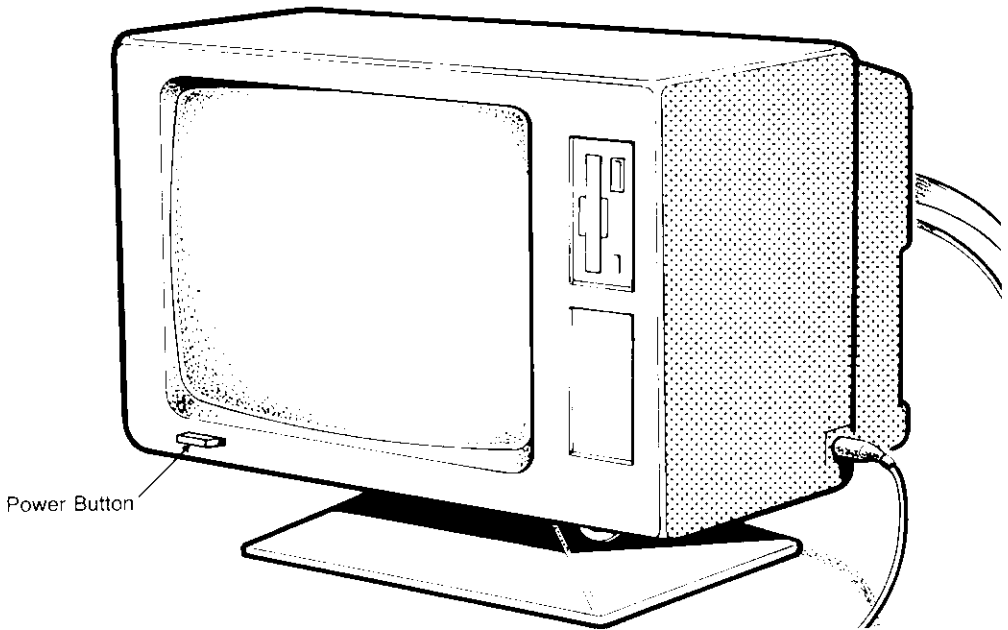

ALWAYS REMEMBER TO REMOVE YOUR DISCS FROM THE DISC DRIVE(S) BEFORE YOU SWITCH OFF

Keeping your work on disc

In the last chapter, we gave you a brief introduction to how Locomotive Software's LocoScript works through preparing a simple letter and then printing it out.

Now we turn to one of the major advantages of a word processor over a typewriter. You can simply and quickly produce a new top copy of a document — there's no need for carbon paper or photocopies. And if you need to make a few minor changes, there is no need to type it in all over again.

This is because you keep an 'electronic' copy of all your work.

While you are working on a document, the computer keeps such a copy in its memory but the moment you change to doing something else or switch off, this copy gets lost. Because of this, you arrange to keep these copies on discs like the ones supplied with the PCW8256 when you bought it.

The discs in the box with your PCW8256 are specially protected so that you can't spoil the software that is stored on them. That's why you got that strange message before you could start working on the letter to Fred. So before you start using your PCW8256 properly, you will need to have available some blank discs that you can store documents on.

3.1 Discs for the PCW8256

The PCW series' built in disc drives can only accept 3inch Compact Floppy Discs.

There are many different kinds of computer disc, so when buying spare discs or software on disc, you should always check that you buy the right sort.

The Compact Floppy discs are thin rectangular objects, about three inches wide, four inches long and 0.2inch thick, and they are made by most of the major computer disc manufacturers around the world. The discs themselves are circular, as their name would suggest, but they are enclosed in a plastic outer casing to protect them. They are perhaps the most sensitive parts of your computer system.

If you have a 2-drive system, refer to the section entitled 'Discs and drives' at the end of this manual.

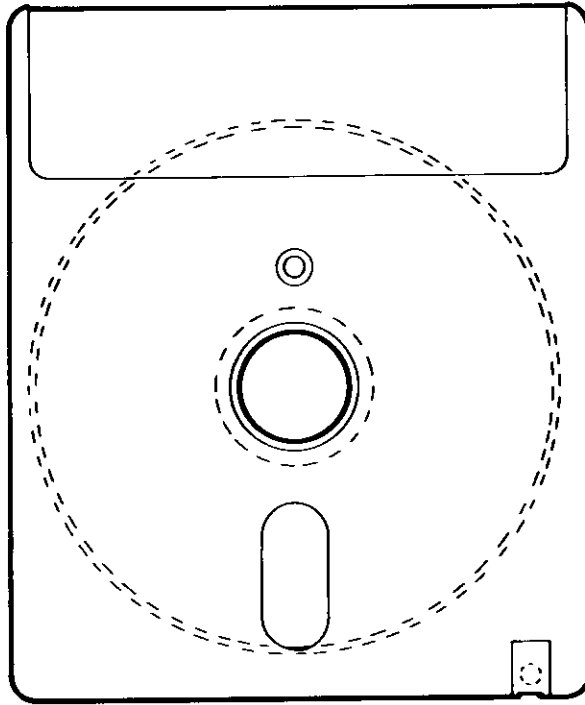

We recommend you use Amstrad CF-2 discs, but in fact labelled discs from any leading manufacturer should give good service. But we do suggest you avoid using cheap, unlabelled discs because use of these is a false economy. Not only is data transfer between discs likely to be unreliable, but in the worst case, use of such discs can damage your disc drives and possibly all the other discs you try using in the drives.

The sides of the disc are usually labelled **A** and **B** or **1** and **2**. Amstrad discs are labelled **1** and **2**.

Both sides of the disc can be used for data or program storage. In all cases, they are treated quite independently: what is stored on one side of the disc in no way affects what is stored on the other.

A feature of 3inch compact floppy discs are their Write Protect Holes, positioned in the top left hand corner of the disc (as you look at it). They may further be identified by the arrows moulded into the casing that point to them.

Write Protect Holes, as their name suggests, offer you a means of protecting the contents of a disc against accidental overwriting or erasure. With the hole on a particular side closed, data can be written to that side of the disc, but with the hole open, attempts to write to the disc will only generate messages on the screen like:

Disc write protected

Always remember: opening a write protect hole only secures the data on that side of the disc against overwriting or erasure.

The method used to open and close the hole varies from disc manufacturer to disc manufacturer. For example, the Amstrad CF-2 discs have a shutter arrangement that can be opened and closed with your thumbnail.

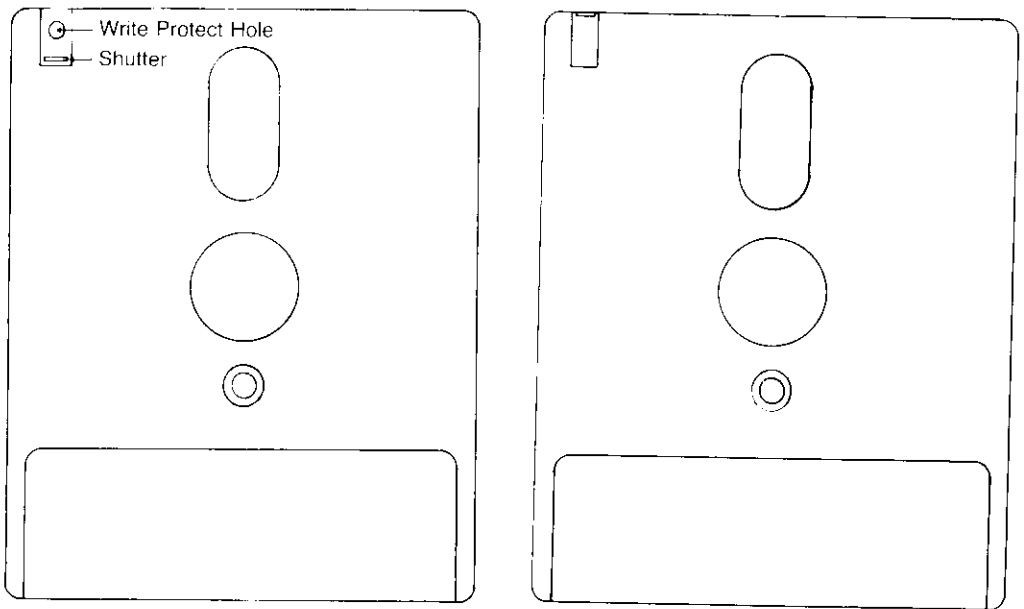

Others have a small lever, set into the edge of the disc casing, by the hole. These can be moved with, for example, the aid of the tip of a ball point pen.

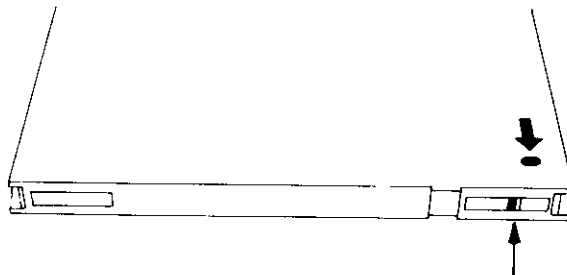

The system discs supplied with the PCW8256 have their Write Protect Holes fixed permanently open.

Some of the software you buy will also be on discs that have been permanently Write-Protected but not all. For your own benefit, we would recommend you open the holes on any software discs you buy before you use them, unless the holes are already open.

The other important characteristic of the discs that can be used in the PCW8256 is their Format, ie. the way data is stored on them. Data written on a disc with the wrong format cannot be read by the PCW8256 and a disc must have this format before the PCW8256 can write anything onto it.

A disc of the right format is marked out as 40 concentric Tracks with each track divided into nine equal Sectors. The tracks are numbered from 0 to 39, starting at the outside and working inwards, while the sectors have numbers from 1 to 9.

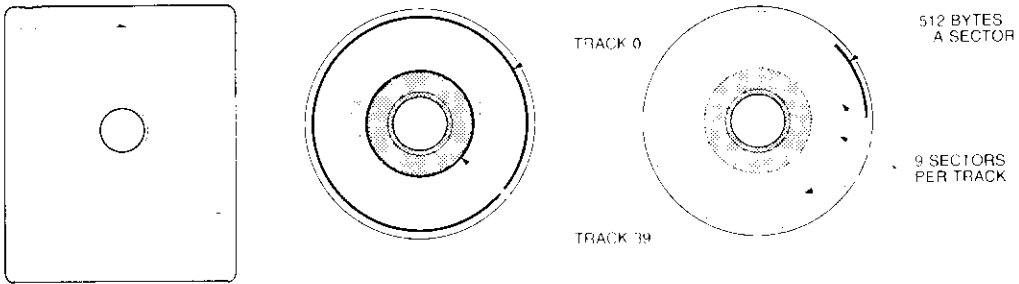

Suitable discs are described as being PCW8256 Format discs and you should always check that the software packages you buy from your computer dealer are PCW8256 Format.

The PCW8256 can also read discs that were produced for the DDI-1, CPC664 and the CPC6128.

If the PCW8256 ever encounters a problem in reading or writing data in a particular sector, it will tell you where the problem is by giving the relevant track number and sector number. If you experience such problems repeatedly in the same track and sector, then this is a sure sign that the disc has been damaged and we would advise you to stop using that disc as soon as you can.

Any blank discs you buy won't have the track and sector information on them. The process that puts this information on the disc is called Formatting and the program that you will need to run to format any blank disc is called DISCKIT. It is on Side 2 of the System Discs supplied with your PCW8256.

DISCKIT is not an integral part of LocoScript. To run this program you have to run the software that makes the PCW8256 a personal computer rather than a word processor – the CP/M Plus operating system.

We explain about using DISCKIT in Section 3.2. There are a few general points about discs that we need to know first.

You can find out more about the PCW8256 as a personal computer from the second part of this manual: 'CP/M Plus for the PCW8256'

3.1.1 How to handle discs

The thing to remember about your discs is that they are highly sensitive – to dust, to temperature, to moisture and to magnets. If they weren't so sensitive, they wouldn't be able to store so much data in such a small area.

So:

- Don't try to force open their plastic casing or poke anything into it
- Don't store them anywhere where they could get either damp or very hot or very cold
- Don't store them anywhere near a magnet and that includes the magnets within such pieces of equipment as the loudspeakers of your audio equipment
- Don't put them into your computer before you switch on and don't turn off the computer with a disc still in the drive
- Don't take them out of a drive while the computer is reading from them or writing to them

Treat discs with due respect, and you will get good service from them.

3.1.2 Loading and unloading discs

Loading a compact floppy disc into the PCW8256's disc drive simply involves inserting the disc into the drive slot the right way round.

Hold the disc by its labelled end, with the side you wish to use to the left. Now insert the disc into the drive slot until it clicks home.

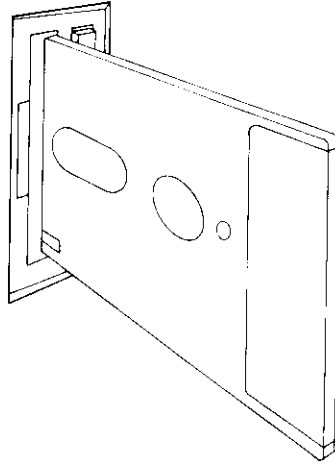

All this should require no more than gentle pressure: if the drive appears to be resisting the disc, stop. Whatever you do, don't force it. You could have a disc already in the drive (check by pressing the Eject button).

If you can't find out what the trouble is, consult your dealer.

The other thing to remember is that you can damage your discs by inserting them before switching the computer on, or for that matter by leaving them in while you switch it off.

Removing a disc from the drive should also be a simple action. You first press the Eject Button on the drive, which releases the disc – causing it to pop out of the drive a short way. Then you pull the disc out the rest of the way.

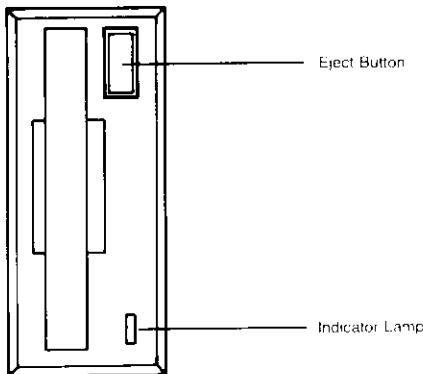

The other feature of the front of the disc drive is its Indicator Lamp. This is brightly lit when the disc in the drive is either being written to or read from.

Never press the Eject Button on a disc drive while the disc is being read from or written to. Not only could the data on the disc be damaged but the disc itself could also suffer.

There are two ways of telling whether a disc is being read from or written to. One of these is that the Indicator Lamp is either on or flashing on and off; the other is the 'Using' message in the top right hand corner of the screen. For example, 'Using A' means that the PCW8256 is reading from or writing to the disc in Drive A. You are advised not to release the disc in Drive A while this message is displayed.

But remember: accidents can happen – so always keep 'Back up' copies of your important documents and data on separate discs. You can either do this a document at a time by using LocoScript's Copy facility or copy whole discs as we describe below.

3.2 Making copies of discs

This section describes in particular how to make Back-up copies of all your system discs. This should be almost the first thing you do after you get your PCW8256. That way, you can keep the original set safely stored away as a Master set – only to be used to make further copies from in case of accident – and use your second set to work on the computer.

But the method described here is used whenever you want to make a copy of a disc and we strongly advise you to make copies of your discs regularly – just in case you damage the discs you work with.

An important point to remember about it is that you can't make your copy from within the LocoScript word processing system. You always have to move over to using the CP/M Plus software for this – ie.

- Remove your LocoScript disc.
- Select Side 2 of the system discs and insert the disc with this side to the left.
- 'Reset' the PCW8256 by holding down the [SHIFT] and [EXTRA] keys and then pressing the [EXIT] key. This terminates your current work with LocoScript and loads new software from the disc – in this case the CP/M Plus software.

The screen should now look like this:

```
CP/M Plus Amstrad Consumer Electronics plc
v 1.4. 61K TPA, 1 disc drive, 112K drive M:
A>
```

If it doesn't, check that you put the right disc in the drive.

The next thing to do is to just type:

```
DISCKIT
```

and then press the **[RETURN]** key. This makes the computer run the special software called DISCKIT that lets you make copies of discs.

On the screen you will see the following:

```
DISCKIT v 1.2
PCW8256 & CP/M Plus
© 1985 Amstrad Consumer Electronics plc and Locomotive Software Ltd.
```

```
One drive found
Please remove the disc from the drive
Press any key to continue
```

Having removed the disc and pressed any key as instructed, you may now start the copying process. DISCKIT is very easy to operate - all you need do is follow the instructions on the screen:

	f 6	Copy	
	f 5		
	f 4	Format	
	f 3		
Exit from the program	EXIT	f 2	Verify
		f 1	

We are now going to copy Sides 1 to 4 of our master discs, so press the **[F6/F5]** key and you will see the following message:

```
Y
```

To make a copy of a CF2 disc, put the correct side of the disc you wish to READ from into the drive, then press Y

To cancel and return to the main menu press any other key

(If you have a 2-drive system, you should now refer to the section entitled 'Copying using DISCKIT' in Part III of this manual, towards the end.)

We will copy each side of the master discs in order, ie. Side 1 followed by Side 2, Side 3, and then Side 4.

So now insert the first master disc in the drive with Side 1 (LocoScript) facing the screen, then press the **Y** key.

Note that DISCKIT will now carry out the copying operation in two 'parts'. On the screen you will see a message similar to:

```
Copying in 2 parts
Copying part 1
```

After a while, you will be asked to 'insert the disc to write' whereupon you must take out the master disc and insert the blank disc to be copied onto.

Continue following the instructions on the screen for part 2 of the copy operation, and you will eventually see the message 'Copy completed - Remove the disc from the drive'. When you see this message, take your newly copied disc out of the drive and write 'Working system disc - Side 1 (LocoScript)' on its label.

DISCKIT then gives you the option of copying another side, so now insert Side 2 of the master disc in the drive, press the **Y** key, and go through the copying sequence again. Then repeat for Sides 3 and 4.

If after you have finished all your copying, you wish to return to your word processing work, insert your new copy of Side 1 in the drive, then hold down **[SHIFT]** and **[EXTRA]** and press **[EXIT]** to start up LocoScript as before.

3.2.1 Notes about copying

The above procedure can be used to copy any suitable disc to another -just remember to follow the instructions on the screen.

If you accidentally mix up the disc you are reading from (the Read disc) and the disc you are writing to (the Write disc), this will be spotted and an appropriate message displayed.

Any error messages that appear should be self explanatory, but if you feel in need of extra help, refer to Chapter 5, Section 5.1, of the CP/M Plus User Instructions where the DISCKIT software is described in detail.

3.3 Organising your work

The basis of the LocoScript system is that you store the documents you prepare on discs. Each document is given a Name and is assigned to a Group.

The easiest way of explaining what role each of these has is by comparing documents on discs with letters or reports in a filing cabinet.

Each Document is an individual letter or memo or report stored in a file. Unlike filing cabinets where you usually put several documents in a file, computer files only have one document in them.

The document's Name is its reference code – the equivalent of the label on the front of the file.

Its Group is the section that the file is stored in: so the equivalent of the group LETTERS would be all the files stored between the section divider marked 'Letters' and the next one.

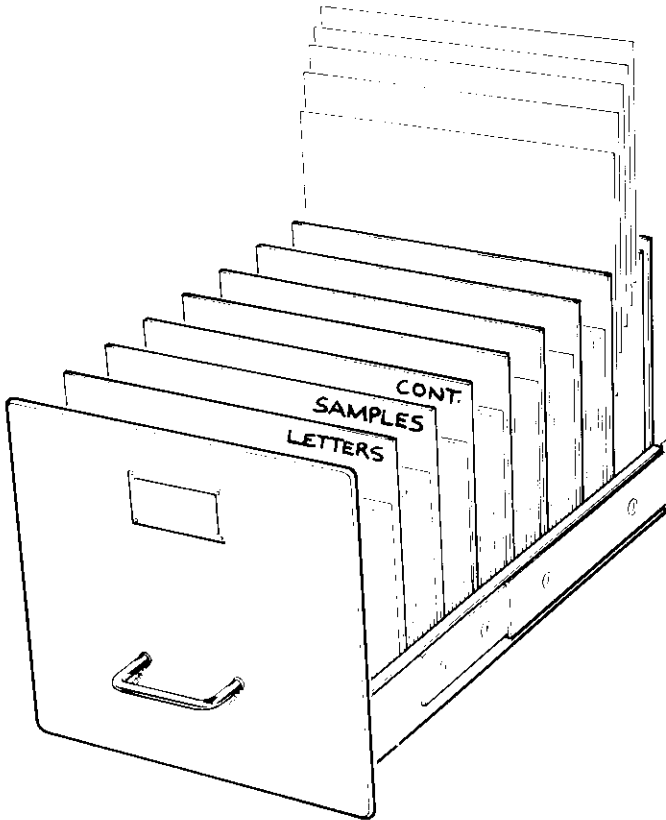

The equivalent to the Disc is one drawer of the filing cabinet, and when you put the disc in your drive, it is like opening this drawer of the cabinet.

The problem of working out what to call a document, what group to store it in and which disc to store it on is exactly the same as working out what file to put a document in, then which section and then which drawer.

However, although you make all the rules for the filing system in your filing cabinet, LocoScript makes some of the rules for the filing system on your discs.

For instance, Filenames (ie. the names of your documents) have a main part that is no more than eight characters long and an optional second part that is no more than three characters long. The second part of the name is separated from the first by a dot. So, for example, you can call a document 'ADVERT' or, if you like, 'ADVERT.EG'

Moreover, not all the characters you can type can be used in a filename. The characters we recommend using for the filename are just the letters A..Z and the digits 0..9.

When you are typing in the name of a document, you don't have to type the name in capitals – LocoScript automatically translates any lower case letters you type into upper case ones.

Your choice of name for a Group is limited to no more than eight letters and digits. Moreover, you can't have more than eight groups on one disc.

The other way the analogy with a filing cabinet breaks down is that, whereas you often file documents in a filing cabinet according to subject, you group documents on a disc according to what type of document they are.

The reason for this is that each group has associated with it a template for all the files in the group. This template controls how the text will be laid out when it is printed.

The LETTERS group, for example, could have a template that has your address already set up and the position for the address of the person you are writing to marked. This position would be right for your window envelopes, say.

The three groups 'LETTERS', 'SAMPLES' and 'CONT' on Side 1 of your system discs each have such a template already set up for them. This is stored in the document called TEMPLATE.STD. You will see that there is a document called TEMPLATE.STD in each of these groups.

Because we recognise that these templates won't suit everyone's needs, we have also set up another group called 'TEMPLATE'. Any of the documents in this group could take the place of one of the initial TEMPLATE.STD documents.

Later, when you are more familiar with LocoScript, we suggest you display the three `TEMPLATE.STD` documents and these alternative templates on your screen in turn and decide which ones meet your particular requirements. Erase any of these documents you don't plan to use as a template. Then move each of the remaining ones to its appropriate group and rename it `TEMPLATE.STD`

If a group does not have a `TEMPLATE.STD`, then LocoScript tries to find an appropriate template to use. If nothing else can be found, it will use a very simple template called the Default. This just ensures that the text will be suitable for printing on A4 paper.

If you start putting documents in another group, you will either set up a `TEMPLATE.STD` specifically for this group or use the simple one that LocoScript uses when nothing else is available. We will tell you about setting up a new template in Stage 10 of the Guide to LocoScript section of this manual.

3.3.1 Keeping your filing system up to date

Just as you sort out a filing cabinet from time to time, so you will want to sort out what you have stored on your discs. Once again we can draw direct analogies between the operations involved.

For example, Copying a document is equivalent to taking a photocopy of a letter and storing this in a folder in another part of your filing system. In both cases, you can either keep the same reference code for the document or give it a different one.

Moving a document is equivalent to taking a file out of one section of the drawer and putting it into another one – either in the same drawer or in a different drawer.

Renaming a document is equivalent to giving it a new reference code but leaving it in the same folder.

Erasing a document is equivalent to taking a file out of the front sections and moving it to the back section of the drawer, throwing it away only when there is no longer room for it in the drawer.

It is not equivalent to throwing it away immediately in the bin, thanks to a special feature of LocoScript that means that all the files you erase are initially put into a state of Limbo. There these documents stay until the room they are taking up on the disc is needed for some new document, whereupon just enough of the older ones get thrown away to make space for the new document.

The real advantage of Limbo is that it allows you to bring back documents that you erase by accident, provided (of course) that you do this fairly soon after you made the initial mistake. You also have the chance to revive documents that you had thought you no longer needed.

But you should remember that confidential information, for example, could remain around for a while. If you don't want that to happen, erase it completely - by following the instructions on page 44.

3.4 Managing your discs

All the disc operations we have been describing above are carried out when the screen is showing the initial LocoScript display:

Disc management.				Printer idle. Using none.			
C=Create new document		E=Edit existing document		P=Print document		D=Direct printing	
f1=Disc change		f2=Inspect		f3=Copy		f4=Move	
f5=Rename		f6=Erase		f7=Modes		f8=Options	
Drive A:	LOCOSCRP.V1	Drive B:	not fitted	Drive M:	LOCOSCRP.V1		
124k used	49k free	25 files	0k used	0k free	0 files	2k used	100k free
PHRASES	840	group 4		LETTERS	1k	group 4	0k
SAMPLES	12k	group 5		SAMPLES	0k	group 5	0k
CONT	1k	group 6		CONT	1k	group 6	0k
TEMPLATE	17k	group 7		TEMPLATE	0k	group 7	0k
A:LETTERS 7 files		A:SAMPLES 5 files		A:CONT 1 files		A:TEMPLATE 12 files	
0 liabo files		0 liabo files		0 liabo files		0 liabo files	
PHRASES .STD	1k	ADVERT .EG	1k	TEMPLATE .STD	1k	LET2PAGE .HDP	2k
READ .ME	6k	DOCUMENT .EG	4k			LET2PAGE .PLP	2k
TEMPLATE .STD	1k	LAYOUT .EG	1k			LETTER .HDP	1k
4 hidden	86k	QUOTE .EG	3k			LETTER .PLP	1k
		TEXT .EG	3k			MANUSCRP .	2k
						MEMO .	2k
						PAGENUM .CEM	1k
						PAGENUM .PR	1k
						PAGENUM .RJ	1k
						PHRASES .LET	1k
						PHRASES .NUL	1k
						TEMPLATE .LAB	2k

For this reason, this screen is known as the Disc Manager.

You will often want to use the facilities offered from the Disc Manager. You automatically get an opportunity to do this each time you load the LocoScript software and each time you finish working on a document.

How to move about the screen.

Disc management.				Printer idle. Using none.			
C=Create new document		E=Edit existing document		P=Print document		D=Direct printing	
f1=Disc change		f2=Inspect		f3=Copy		f4=Move f5=Rename f6=Erace f7=Modes f8=Options	
Drive A: LOCOSCRP.V1		Drive B: not fitted		Drive M: LOCOSCRP.V1			
49k free 25 files		0k used 0k free 0 files		2k used 100k free 2 files			
Group Cursor							
MANUSCRIPTS	4k group 4	0k		LETTERS	1k group 4	0k	
SAMPLES	12k group 5	0k		SAMPLES	0k group 5	0k	
CONT	1k group 6	0k		CONT	1k group 6	0k	
TEMPLATE	17k group 7	0k		TEMPLATE	0k group 7	0k	
A:LETTERS	7 files	A:SAMPLES	5 files	A:CONT	1 files	A:TEMPLATE	12 files
0 limbo files		0 limbo files		0 limbo files		0 limbo files	
PHRASES .STD 1k		ADVERT .EG 1k		TEMPLATE.STD 1k		LET2PAGE.HDP 2k	
READ .ME 6k		DOCUMENT.EG 4k				LET2PAGE.PLP 2k	
TEMPLATE.STD 1k		LAYOUT .EG 1k				LETTER .HDP 1k	
4 hidden 86k		QUOTE .EG 3k				LETTER .PLP 1k	
		TEXT .EG 3k				MANUSCRP. 2k	
						MEMO 2k	
						PAGENUM .CEN 1k	
						PAGENUM .PR 1k	
						PAGENUM .RJ 1k	
						PHRASES .LET 1k	
						PHRASES .NUL 1k	
						TEMPLATE.LAB 2k	

The columns in the lower part of the screen hold alphabetical lists of the documents on your discs, divided into their Groups. Each group that you have any documents in has its own column or columns.

Between this and the information lines at the top are three summaries of the Groups you can put files in. There are eight entries in each section corresponding to the eight groups you can have on any disc.

The three sections are labelled Drive A, Drive B and Drive M. They also display other information, such as how much free data space there is and any special name that has been given to the disc.

Drive A is your disc drive – or your upper one if you have two.

Drive B will be marked as 'not fitted' unless you have a PCW8512 or a PCW8256 with two disc drives, when your lower drive will be Drive B.

Drive M is a special feature of the PCW8256. It is a section of the computer's memory that is used just like a powerful additional disc drive. It is very fast.

Your main use of Drive M will be an intermediate storage place for files while you copy from one disc to another, as we shall describe in Section 3.4.1.

It is also used as a storage place for information while you are editing documents. LocoScript needs somewhere it can store information but still get it back quickly as soon as it is needed.

Nothing can be stored long term in Drive M because the information is lost as soon as you switch off or reset the PCW8256.

The columns of filenames at the bottom take the groups of documents stored on the three drives in turn, starting with the first group on Drive A. Although you can have up to eight groups on each drive, only the ones with files in them are displayed here.

There is always one group name highlighted because it has the Group Cursor over it. You can move this from group to group and from drive to drive by holding down the Shift key and pressing the cursor keys.

One document name is similarly highlighted: this is the one the File Cursor is on at present. You can move the File Cursor with the cursor keys to whichever document you want.

Because no column of filenames is set aside for those groups without any files in them, if you move the Group Cursor to such a group, the File Cursor temporarily contracts until you move to a different group.

Experiment with the Group and File Cursors for a while.

As you move through the list of groups, you will notice the columns of filenames scroll across the screen. This is the way LocoScript manages to display all the names of the documents you have available. Obviously, it would be impossible to have a column for every group permanently on the screen.

3.4.1 The operations available

Everything you can do from the Disc Manager screen is outlined in the two information lines at the top of this screen. These lines give you the names of the keys to press to start things happening, alongside a brief description of the operation. The top line gives you some basic word processing functions, while the second line offers you standard 'Disc Housekeeping' operations.

A number of the Disc Manager functions reduce the amount of information you need to type in by treating the document that has the File Cursor on it as the Current Document.

If you press the key that gives you Editing, Printing, Erasing, Copying, etc., the menu that this calls up offers you the Current Document first. If this is not the document you want, you can type in any changes that need to be made to these details. This 'new' document then becomes the Current Document until you move the File Cursor again.

If you press **C** to Create a new document, then it is the position of the Group Cursor that is important because LocoScript takes this group and drive as your starting point. This information not only dictates where your document will be stored but also the way it will be set out on the page. (Each group has a basic layout associated with it, stored in the TEMPLATE.STD file.) Get the right drive and the right group and you will save yourself a lot of unnecessary work.

We introduce all the operations here. The Disc Housekeeping ones we describe in detail; most of the Word Processing operations are covered more fully later in this manual.

Word Processing operations

C=Create new document To use a brand new document, you have first to press the **C** key.

Create document
Name: DOCUMENT.DDD
Group: LETTERS
Drive: A

The menu that appears has three parts - one for the name of the document, the next for the group to put it in and the third for the drive (ie. the disc) to store it on. LocoScript makes some suggestions for what you might like all these to be. The group and drive are set by location of the Group Cursor when you pressed **C**

You don't have to accept these suggestions. Remember, the group you give a document affects the template you prepare it with. All you need to do to change any one of them is to move the cursor in the menu to the entry you want to change and then type in what you want it to read. In particular, if you want to change the details of the group, type the right group name (or its number if the group has not been given a name).

When these three lines are what you want, press **[ENTER]** and you will be given a new document with the correct template to start working on.

E=Edit existing document To edit one of the documents you have already saved on the disc, start by pressing the **E** key.

The menu initially displays the details of the Current Document.

When you have checked that the correct details of the document you want to edit are displayed in the menu, press **[ENTER]**. Then the top section of this document will be displayed on the screen, all ready for you to edit.

P=Print document The key to press when you want to print a document that you have previously stored on disc is **P**.

The menu initially displays the details of the Current Document.

Further details are given in Stage 8 of the Guide to LocoScript.

D=Direct printing Pressing the **D** key sets up the PCW8256 so that as you prepare your document on the screen, it also gets printed line by line on the printer. Using the PCW8256 in this way is also described in Stage 8 of the Guide to LocoScript.

Disc Housekeeping

f1=Disc change You need to tell LocoScript every time you release the disc from the drive and put in either another one or the same one the other way up. To do this, press **[f1]** immediately after you make this change.

f2=Inspect gives you a way of quickly checking what is in a document: just position the File Cursor over the document you are interested in and press **[f2]** (ie. **[SHIFT] + [f1]**). The information displayed has to have been set up in advance. Inspecting documents is covered fully at the end of Stage 10 of the Guide to LocoScript.

f3=Copy Place the File Cursor over the document you want to copy, then press **[f3]**. A message appears on the screen, asking you to move the Group Cursor to the group in which you want the copy to be stored. Do this by holding down the **[SHIFT]** key at the same time as pressing the Cursor keys. This enables you to pick out any group – even one that does not yet contain any documents. If there are documents already in the group, you can get the same result by moving the File Cursor. You can, if you wish, store the copy in the same group as the original document.

Press **[ENTER]** when the Group Cursor is on the correct group. A menu is then displayed on the screen, which gives you details of both the new document and the one being copied based on where you placed the File and Group cursors. If the copy is to be in a different group, then LocoScript suggests that it retains the same name but if it is to be in the same group, it asks you for a new name. No two documents in the same group can have the same name.

Any of the details displayed in the menu can be changed. In particular, if you want to change the details of a group, type the right group name (or its number if the group has not been given a name). When all the details are correct, press **[ENTER]**.

If you want the copy to be stored on a different disc and you have a single-drive system, first make a copy on Drive M. Then change the disc in the drive to your second disc (press **[f1]** to signal this change) and move the copy from Drive M to your second disc (see below).

f4=Move Place the File Cursor over the document you want to move and then press **[f4]** (ie. **[SHIFT] + [f3]**). After that, the steps you go through in moving a document are exactly the same as those for Copying. The difference in the result is that no copy of the document remains in the original group, although one is held in limbo if the move is made to a different disc.

f5=Rename The four actions this leads to are

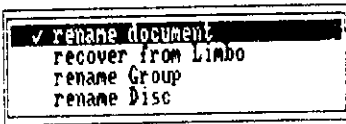

Renaming a document;
Recovering a document from Limbo;
Renaming a group;
Renaming a disc.

Position the File Cursor correctly if you want to either rename a document or recover one from Limbo. Otherwise, just ensure that the Group Cursor is over the appropriate group. It is a good idea (but not essential) to use the Options menu (| *f5* |) to display Limbo documents if you wish to recover one of these.

Press [*f5*], move the cursor to the option you want and press [ENTER]. Another menu appears that lists the details of the item you have picked out and asks you for a new name. If you want to recover a file from Limbo and you pointed the File Cursor at this file before pressing [*f5*], LocoScript will suggest you retain the same name – unless there is already a document of that name. If you weren't pointing at a Limbo file, it will also ask for the name of the file you want to recover.

Any of the details displayed in the menu can be changed. In particular, if you want to change the details of a group, type the right group name or its number if the group has not been given a name. When all the details are correct, press [ENTER].

f6 – Erase To erase a document, position the File Cursor over the document you want to erase and press [*f6*]. Press [ENTER] when you have checked that you have picked out the right document. This puts the document into Limbo from which it is recoverable through the Rename menu.

If you want to erase the document completely, use [*f6*] to display all the documents in Limbo and point the File Cursor at the document you want to erase. Press [*f6*] and then [ENTER] as before: that erases the Limbo document completely. If you don't want to go through the stage of displaying the Limbo documents, press [*f6*] again and change the details given there to those of the Limbo document you want to erase. In particular, move the cursor to the Group line of the menu and press the [↑] key to tell LocoScript it is a Limbo document you want to erase.

f7 – Modes is there to open the door to add-on software packages for LocoScript. The choices offered when you press [*f7*] will depend on what additional software has been installed on your system. The way these pieces of software work will always be documented elsewhere.

f8 – Options gives you a way of showing what documents are currently in limbo.

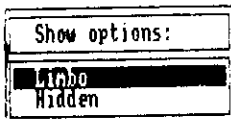

It will also let you display the names of any 'Hidden Files' on your system. There may be some Hidden Files associated with your add-on software packages.

On your system disc, the 'Hidden Files' are those of the LocoScript word processing software itself. Hidden files need not be of any concern to you whatsoever.

Press [*f8*] (ie. [SHIFT] + [*f7*]), move the menu cursor and press the [↓] key to select the options you want. These extra files will be listed on your screen when you press [ENTER].

Disc management.				Printer idle.				Using none.																																																																																											
C=Create new document				E=Edit existing document				P=Print document				D=Direct printing																																																																																							
f1-Disc change				f2-Inspect				f3-Copy				f4-Move				f5-Rename				f6-Erase				f7-Modes				f8-Options																																																																							
Drive A:								Drive B:								Drive M:																																																																																			
132k used 41k free 28 files								not fitted 0k used 0k free 0 files								2k used 100k free 2 files																																																																																			
LETTERS 101k group 4 0k				SAMPLES 13k group 5 0k				CONT 1k group 6 0k				TEMPLATE 17k group 7 0k				LETTERS 1k group 4 0k				SAMPLES 0k group 5 0k				CONT 1k group 6 0k				TEMPLATE 0k group 7 0k																																																																							
A:LETTERS 9 files				A:SAMPLES 6 files				A:CONT 1 files				A:TEMPLATE 12 files				1 limbo files				0 limbo files				0 limbo files				0 limbo files																																																																							
DOCUMENT.000 2k				PHRASES .STD 1k				QUOTE .ASC 2k				READ .ME 9k				TEMPLATE .STD 1k				4 hidden 86k				ADVERT .EG 1k				DOCUMENT.EG 4k				LAYOUT .EG 1k				PITCH .EG 1k				QUOTE .EG 3k				TEXT .EG 3k				TEMPLATE .STD 1k				LET2PAGE .HDP 2k				LET2PAGE .PLP 2k				LETTER .HDP 1k				LETTER .PLP 1k				MANUSCRP. 2k				MEMO 2k				PAGENUM .CEN 1k				PAGENUM .PR 1k				PAGENUM .RJ 1k				PHRASES .LET 1k				PHRASES .MUL 1k				TEMPLATE .LAB 2k			

3.5 Preparing discs for use

When you use your PCW8256 in earnest, you will essentially have three sorts of discs – identical in appearance but different in the type of information you have stored on them. You will have:

- **System discs** with the software the PCW8256 needs to provide all its facilities.
- **Start of Day discs** which have just the software on them needed to run LocoScript. This is quite large but there is some room left which you can use to store a few documents. Typically, you would use this space to store standard letters or whatever that you use frequently because then you will be able to switch on, load the LocoScript software and then start processing the standard letter right away – without swopping discs.
- **Data discs** which have only your saved documents on them. These cannot be used until LocoScript has been loaded from a Start of Day disc.

There is also a fourth type of disc you might use CP/M discs. These are used when the PCW8256 is running as a personal computer (see the CP/M Plus User Instructions). But we advise you not to store LocoScript documents and CP/M files on the same disc.

Before you can use LocoScript properly, you need to prepare at least one Start of Day disc and you might also find it useful to prepare a Data disc. We describe making these below.

On a Start of Day disc, you don't need any of the sample documents we have put on the System disc. These are intended purely to help you while you are learning how to use LocoScript. So what you need to do is to 'erase' **just** these documents: everything else is needed.

To erase any document you don't want, all you have to do is to move the File Cursor over the name of the document and then press [*f6*], followed by [*ENTER*] to confirm the action.

The documents to erase are:

ADVERT. EG
DOCUMENT. EG
LAYOUT. EG
QUOTE. EG
TEXT. EG

When you have erased all these documents, you have finished making your Start of Day disc.

This gives you a certain amount of disc space to store your own documents in, but less than half the amount of space you have on a Data Disc. This is why you need to prepare data discs as well.

You can see the exact figure in the Drive A section of the Disc Manager screen. (The letter 'k' stands for Kilobyte – the unit in which space on a disc is always measured – and it corresponds to just over 1000 characters.)

3.5.2 Making a Data Disc

There are two ways of preparing a data disc. One is to copy a Start of Day disc (or Side 1 of the system discs) and remove everything **except** the TEMPLATE.STD files. This method retains some templates for you to work with.

The other is called Formatting: this gives you a blank disc but one that is laid out ready to store documents for you. It will not contain any templates for the documents you create.

Formatting

What you usually format is a new blank disc but you can also format old discs. However, if you do plan to format an old disc, check first that you don't want any of the documents currently stored on it or that you have copies elsewhere of the documents you still want. Formatting a disc clears it of everything that had been stored there.

The first stage of formatting (assuming that you have already switched your PCW8256 on) is to place your System Disc in the drive with Side 2 to the left. Then hold down [*SHIFT*] and [*EXTRA*] and press [*EXIT*] to get the PCW8256 to read software from this disc into its memory.

The screen should now look like this:

```
CP/M Plus Amstrad Consumer Electronics plc
v 1.4, 61K TPA, 1 disc drive, 112K drive M:
A>|
```

If it doesn't turn to Section 1.2 of the CP/M Plus User Instructions and use the advice given there to sort out what has gone wrong.

Once again, the piece of software we need here is DISCKIT. So the next thing to do is to type in:

```
DISCKIT
```

and then press **RETURN**.

Then all you have to do is follow the instructions.

The first set of screen messages tell you that to start the formatting process you have to press the **F4/F3** key.

(If you have a 2-drive system and you wish to format CF-2DD discs for Drive B, you should now refer to the section entitled 'Formatting discs for Drive B' in Part III of this manual, towards the end.)

Any error messages that appear should be self explanatory, but if you feel in need of extra help, refer to Chapter 5, Section 5.1, of the CP/M Plus User Instructions where the DISCKIT software is described in detail.

3.5.3 Let's make a data disc

We will now make a data disc with a couple of customised templates on it. Once this data disc is made, you can duplicate it any number of times and use these duplicates for storing all your LocoScript files onto. You will only ever need to use the LocoScript system disc itself as a start of day disc.

Start up LocoScript using the start of day disc, and when you see the initial LocoScript display, insert a newly formatted disc and press **F2/F1**.

Let's say that we have decided to rename the first two groups 'MEMOS' and 'NOTES'. First check that the group cursor is positioned over group 0 on Drive A. If it isn't, then hold down **SHIFT** and use the cursor keys until it is. Now we're going to Rename 'group 0' so press the **F6/F5** key and you will receive the following menu:

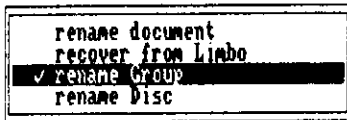

Press the Down Cursor key twice to select the rename Group option then press **[ENTER]** . You will receive the following menu:

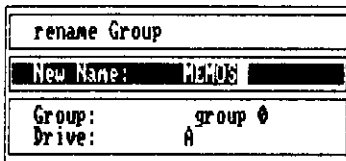

Type in the new name for the group, ie. MEMOS then press **[ENTER]** (you will see the new name appear under the group cursor).

To rename the second group, hold down **[SHIFT]** and press the Down Cursor key once. The group cursor should now be positioned over group 1 on Drive A. If it isn't, then hold down **[SHIFT]** and use the cursor keys until it is.

Again using the **[f6/f5]** Rename function, change group 1 to 'NOTES'.

Now that we've renamed two of the groups, let's create a customised template for memos. Move the group cursor over the MEMOS group and press **C** (to Create a file). The menu that appears will offer you the filename 'DOCUMENT.000'. We don't want that name so overwrite it with TEMPLATE.STD and press **[ENTER]** . TEMPLATE.STD is a special filename which always holds the template for that particular group. LocoScript always looks to see if there's a TEMPLATE.STD file to determine the layout of a document in that group.

Up on the screen will come an address template, (this is because no template yet exists on Drive A, so LocoScript has borrowed one from the TEMPLATE.STD file on Drive M). We don't want an address template so let's 'Cut' it out of the file as follows:

While the cursor is at the beginning of the file, press the **[CUT]** key. Notice how the third line of the top menu tells you that we are about to perform a cut operation.

Press the **[PAGE]** key (to move to the end of the page). Notice how all the text to be cut is highlighted. Now complete the cut by pressing **[CUT]** once again, and you will then be left with an empty file in which to create a new template.

And so to the wording. Let's have the word 'Memorandum' positioned centrally at the top of the document. Press **[f6/f5]** to get the Lines menu -you will see that the option Centre line is already selected, so confirm this selection by pressing **[ENTER]** , then type 'Memorandum' and press **[RETURN]** . On the next line, type 'To:' then press **[f6/f5]** to get the Lines menu again. Use the Down Cursor key to select Right justify line and press **[ENTER]** . Now type 'Date:', press **[RETURN]** , type 'From:', press **[RETURN]** , and finally, type a line of dashes and press **[RETURN]** to finish the template off neatly.

```

F1=Show  F2=Layout  F3=Emphasis  F4=Style  F5=Lines  F6=Pages  F7=Modes  F8=Blocks  EXIT
-----
(Centre)
To: (RJust)
From:
Date:
-----

```

That's our memorandum template made, so press **[EXIT]** and confirm the Finish editing selection by pressing **[ENTER]**. You will now see this new TEMPLATE.STD file in the MEMOS group on Drive A.

If you move the group cursor to NOTES, you can also create a customised template for that group in the same manner as just described.

Now try using one of your new templates by creating a document in the MEMOS group. Notice that as soon as you've entered the document's name, you receive your customised memos template on the screen.

Any copies you now make of your data discs will contain your customised templates.

Postscript

You have now been introduced to all the tools you need to set up and keep documents. The next stage is to learn about the facilities LocoScript has for letting you set up really professional documents.

This is covered in the next ten chapters, which together go to make 'A Guide to LocoScript'

A Guide to LocoScript

This Guide to the LocoScript word processing system is in two parts.

The first ten chapters – Stages 1...10 – each offer a brief introduction to a different aspect of the LocoScript system, starting with how to pick out words from your text for special emphasis, moving on through how to lay out text well and how to edit it efficiently, to printing documents out and refining them. The final chapter acts as a source of reference both on how LocoScript goes about the various tasks and on the facilities it provides.

Anyone completely new to word processing should find Stages 1...10 helpful, particularly if they take advantage of the sample documents supplied on the LocoScript disc. The sample documents will enable you to concentrate on following how the various word processing operations work.

We suggest you study each stage in turn at first, and then just dip back whenever you still feel you would like some guidance in addition to the messages LocoScript puts up on the screen.

Most of the stages will involve you editing one of the sample documents and at the end of this procedure, what you are working with will be very different from what you started with. We therefore recommend that, except when you need to print the result of your changes, you choose 'Save and Abandon' from the options offered when you press the **EXIT** key to finish each edit. That way, the stored copy of the document stays unaltered and you can go back and work through the chapter again if you wish.

Typing special characters

Whatever country you use LocoScript in, you can always type its complete range of characters. This covers a wide range of special characters, often unique to a few countries. This means you will be readily able to transfer documents on disc from one country to another.

The PCW8256's keyboard changes from country to country to allow you to type in easily the characters most often used in that country. For example, it will be harder to type a ß on a UK keyboard than on a German one but you will still be able to type this character.

The keyboard maps at the start of this manual show you what keys you have to press to get any particular character.

Accented letters are treated specially. If you study the characters that can be typed in from your keyboard, you will notice accents on their own as well as some accented letters.

Any accented letter can be typed in by first typing the accent (` , ` , ` , ` or `) and then the letter in the normal way. If the combination is one of the characters in LocoScript's character set, it will be displayed on your screen and entered in your document as a single character: otherwise it will be shown as two separate characters.

You therefore have two ways of typing in the accented letters already on your keyboard: either press the key combination given on the keyboard maps or press the accent, followed by the letter.

If you want just the accent, type the accent followed by **[ENTER]** .

CONTENTS

Stage 1: Enhancing the text **55**

Underlining	56
How LocoScript remembers your instructions	59
Other effects	60
A bit of Style	61

Stage 2: Using the simpler editing keys **63**

The textual movement keys	64
Textual movement and editing	65
Deleting sections of text	67
Finding a particular point in the text	68
Moving a section of text	69
Copying a section of text	70
Exchanging one piece of text for another	71

Stage 3: Setting out text **73**

Indenting text	74
Tables	75
Changing the Tab settings	78
Changing the margins	81
Changing an existing layout	83

Stage 4: Refining the appearance of the text **87**

Centring text	87
Right justification	88
Using different character sizes	89
Document layout	91
Line endings	94

Stage 5: Setting out pages	97
What is a page?	97
Changing the line spacing	98
Changing the line pitch	99
Where to start a new page	99
Making more fundamental changes	102
Stage 6: Headings and page numbers	105
Setting up Headers and Footers	105
The first page	109
The end result	109
Stage 7: Cutting and pasting	111
Maintaining your Blocks	112
Pasting in whole documents	112
Using Phrases	113
Stage 8: Printing	115
Printing your documents	115
Direct printing	118
Stage 9: Eliminating keystrokes	121
Using the Set and Clear menus	121
Using abbreviations	122
Doing without menus	123
Stage 10: Setting up a group template	125
A new template	125
Editing TEMPLATE.STD	126
Other changes to the File Header	127
Summaries of your documents	128
LocoScript summarised	129





Enhancing the text

With LocoScript, you can enhance the appearance of the text you print out in a number of ways. You can, for example, make sections of it bolder, underline words or phrases, print some of it in italic (slanted) characters and put in subscripts and superscripts.

Most of these features can be called up when required through the Emphasis menu, one of the eight Editing Menus available to you while you are working on a document.

To show you how this works, we will use one of the sample documents we have included on the disc alongside the LocoScript software – ADVERT.EG.

The starting point for this is the Disc Manager screen, that is the one that appears on the screen after you have loaded LocoScript or after you have finished working on a document.

The file we want is listed in second column of file names. Use the cursor keys ( ,  ,  and ) to move the disc manager's cursor to ADVERT.EG.

If you are not sure how to bring this file onto your screen, turn back briefly to 'How to move about the screen' in Section 3.4.

Press **E** to start editing ADVERT.EG and then **[ENTER]** when you have checked that the document named in the Edit menu is the right one. Your screen should look like this:

```
F1=Show F2=Layout F3=Emphasis F4=Style F5=Lines F6=Pages F7=Modes F8=Blocks EX11
-----
For Sale: Lawnmower
^
^
^
Petrol driven four stroke lawnmower with power drive. Cylinder type
with 14" cut and large grassbox.^
^
^
Would suit person with large garden. Selling because of move to a small
city centre flat.^
^
^
ower is in good condition, and was recently given a service and
thorough overhaul.^
^
^
Price £75^
^
Please contact Chris on Reamsford 776301.^
```

The text we have here is for a small advertisement – the sort of advertisement you might want to put in a newsagent's window or on an office noticeboard. The text is fine, but underlining the title to make it stand out would be a good first step in encouraging people to read it.

Underlining

Underlining is one of the features available through the Emphasis menu, which is listed as f3=Emphasis in the third of the Information Lines at the top of your screen. This tells you that the function key you will need to press is [f3].

Move the cursor to the first character of the title; then press [f3]

Up on your screen will come the Emphasis menu:

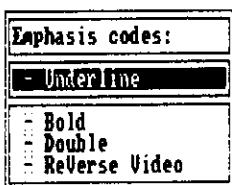

You select a feature you want from this and other LocoScript menus by first using the Up and Down cursors to move the menu cursor to that feature and then pressing the [+] key. This puts a [+] at the beginning of that line of the menu, showing that this feature has been set.

If you want to cancel the selection of this feature, press the [-] key. The [+] then becomes a [-].

When you have set all the features you want, you just press [ENTER] to leave the menu and go back to working on your document.

What we wanted for the title line was underlining. The menu cursor is on this option when you enter this menu.

With the menu cursor on this feature, press the [+] key. You will see the line change to:

[+] UnderLine

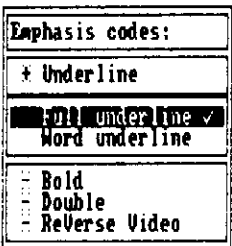

You will also see a new 'Submenu' appear on the screen – asking you whether you want Full Underline (ie. words and spaces underlined) or just Word Underline. 'Full underline' is already selected for you. If this is the type of underlining you would like, just press [ENTER]; if not, either press the Space Bar or move the menu cursor to 'Word underline' and press the [+] key, before pressing [ENTER].

LocoScript won't immediately show underlining on the screen – only when you ask it to relay a paragraph or the whole document. However it will underline any characters you type in anywhere further down the document.

To see what happens, move the cursor down to beginning of the third paragraph and type in
The

```

11=Show 12=Layout 13=Emphasis 14=Style 15=Lines 16=Pages 17=Modes 18=Blocks EX11
-----
|
| For Sale: Lawnmower
|
|
|
| Petrol driven four stroke lawnmower with power drive. Cylinder type
| with 14" cut and large grassbox.
|
|
| Would suit person with large garden. Selling because of move to a small
| city centre flat.
|
|
| The mower is in good condition, and was recently given a service and
| thorough overhaul.
|
|
| Price £75
|
| Please contact Chris on Reamsford 776301.

```

As you see, the effect of 'Full underline' is to underline everything down to the current position of the cursor – including the 'Trailing spaces' at the end of lines within a paragraph. (Incidentally, trailing spaces are only underlined on the screen: they won't be underlined if you print the document out.) To get just the title underlined, we have to tell LocoScript to stop underlining at the end of the title line. To do this, first move the cursor to the carriage return symbol `␣` at the end of the title line.

```

11=Show 12=Layout 13=Emphasis 14=Style 15=Lines 16=Pages 17=Modes 18=Blocks EX11
-----
|
| For Sale: Lawnmower
|
|
|
| Petrol driven four stroke lawnmower with power drive. Cylinder type
| with 14" cut and large grassbox.
|
|
| Would suit person with large garden. Selling because of move to a small
| city centre flat.
|
|
| The mower is in good condition, and was recently given a service and
| thorough overhaul.
|
|
| Price £75
|
| Please contact Chris on Reamsford 776301.

```

Then press [F3] to take you once again into the Emphasis menu.

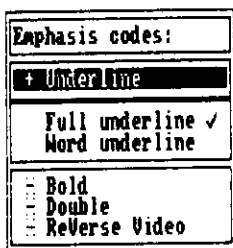

This time we want to cancel our selection of underlining.

You may well think that what we need to do is to clear our selection of Full Underline. To see what happens when you do this, move the cursor to the Full Underline line and press the [] key.

See the / switch from Full Underline to Word Underline?

What we have done would give us every word underlined throughout the rest of the document – not what we wanted. What we need to do is to clear underlining all together, which we do by moving the menu cursor to the line [+] Under Line and pressing the [] key.

Do this now. You will notice that LocoScript's response is to replace [+] by [-] and to close up the submenu: that is because when you clear the underline setting, you clear both Full underline and Word underline.

Now press [ENTER] to go back to working on the advertisement.

To see the effect this has had, move the cursor to the beginning of the first paragraph and press [RELAY]

```
F1=Show F2=Layout F3=Emphasis F4=Style F5=Lines F6=Pages F7=Modes F8=Blocks EX11
For Sale: Lawnmower
Petrol driven four stroke lawnmower with power drive. Cylinder type
with 14" cut and large grassbox.
Would suit person with large garden. Selling because of move to a small
city centre flat.
The Mower is in good condition, and was recently given a service and
thorough overhaul.
Price £75
Please contact Chris on Realsford 776301.
```

If you were to relay a few more paragraphs, you would see that now only the title is underlined, as we wanted.

Moreover, any additions you make to the title will also be underlined. Try this out by typing in Excel lent in front of the word Lawnmower.

How LocoScript remembers your instructions

What we've actually done is to put two special characters into our document. These 'codes' don't normally appear on the screen and they don't get printed, but they do affect the way the document is printed.

Such codes are inserted for many of the word processing actions that LocoScript carries out on your documents.

We can show the codes on the screen through one of the options given in the Show menu.

Looking at the top of your screen, you will see that f1 is the key to press to bring the Show menu onto the screen.

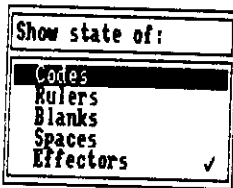

This works just like the Emphasis menu. Anything we want to show the state of, we select by moving the cursor to the right line in the menu and pressing the + key. In this case, we want the Codes option: so with the cursor over Codes, press the + key.

You can tell that the option has now been selected because there is now a / beside it in the menu. Return to editing by pressing the Enter key.

The screen has now changed to:

```

M=Show  L=Layout  E=Emphasis  N=Style  S=Lines  B=Pages  Y=Modes  P=Blocks  L=MIN
-----
  (+UL)For Sale: Lawnmower(-:UL)
  e
  e
  Petrol driven four stroke lawnmower with power drive. Cylinder type
  with 14" cut and large grassbox.
  e
  e
  Would suit person with large garden. Selling because of move to a small
  city centre flat.
  e
  e
  The Mower is in good condition, and was recently given a service and
  thorough overhaul.
  e
  Price £75
  e
  Please contact Chris on Realsford 776301.

```

and the codes we added are now visible.

The codes may seem to be a number of characters but to LocoScript each code is only one character and only one stroke of a Delete key is needed to remove the whole code from the text.

To see this, move the cursor to the start of (+UL) and press [DEL]. You will see the whole of this code disappear.

To see what effect this has had on your text, relay a few paragraphs.

```
1=Show 2=Layout 3=Emphasis 4=Style 5=Lines 6=Pages 7=Modes 8=Blocks 9=101
For Sale: Lawnmower(-UL)
Petrol driven four stroke lawnmower with power drive. Cylinder type
with 14" cut and large grassbox.
Would suit person with large garden. Selling because of move to a small
city centre flat.
The Mower is in good condition, and was recently given a service and
thorough overhaul.
Price £75
Please contact Chris on Realsford 776301.
```

All the underlining has now gone. There is still the 'Cancel underline' code in the text but, with no previous 'Set underline' code, it is ignored. For practice, try using the Emphasis menu to put the 'Set underline' code back.

Other effects

We suggest you now try out some of the other features of the Emphasis menu.

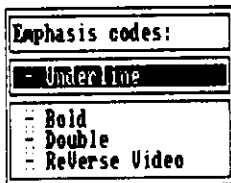

The actions needed to use these are identical.

To set one or more feature(s) for a particular piece of the text, move the cursor to the first character of that text and press [F3]. Then set and clear features within the menu until you have the combination you require, and press [ENTER] to take you back to working on the document.

To **'turn off' the feature(s)** move the cursor to the character after the last one you want to be affected by the feature(s) and press [*f3*]. Then clear and set features within the menu until you have the combination you want for the next section of the text, and press [**ENTER**] as before.

Use the Show Codes option to display the codes you have set into the text.

We suggest you spend some time experimenting with these codes, seeing what effects they have both on the screen and when you print the document out.

You will notice that the screen doesn't change when you relay the document after setting bold or double strike: these features only affect how the document looks when it is printed.

You will also notice that, when you set Reverse Video, this shows up on the screen but is not printed out. You could use this effect in, for example, a letter that you want to send to a number of different people. You would use Reverse Video to highlight the parts of the letter you must remember to change when you prepare the version for the next person on your list.

A bit of Style

There are a couple of effects you might also like to explore at this stage in the Style menu. You access these by pressing [*f4*] (ie. [**SHIFT**] + [*f3*]).

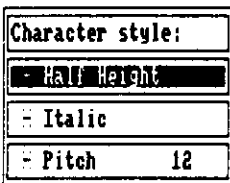

Italic works exactly like Bold and Double-strike.

Selecting Half Height offers you a choice of either Superscript (raised) characters or Subscript (lowered) characters. You can only have one of these options at a time.

None of these options affect how the characters appear on the screen but they do affect how characters appear when the document is printed out.

Using all these effects together, you should be able to produce some very attractive versions of the advertisement.

Using the simpler editing keys

To start with, we have been editing very much the hard way - moving the cursor to the right point in the text, pressing the Delete keys to erase characters we no longer want and typing in additional characters. The only other editing function we have used is RELAY, which relays the text in the paragraph you have been working on.

To illustrate some more of LocoScript's editing facilities, we will start again from the disc manager screen but this time work with the sample text, TEXT.EG. This is one of the second group of files on your disc. If you are not sure how to bring this file onto your screen, turn back briefly to 'How to move about the screen' in Section 3.4.

Press **E** to start editing TEXT.EG and then **[ENTER]** when you have checked that the document named in the Edit menu is the right one. Your screen should look like this:

```
f1=Show f2=Layout f3=Emphasis f4=Style f5=Lines f6=Pages f7=Index f8=Blocks f9=
```

BASIC was originally designed many years ago as a programming language that was simple to learn, to aid teaching. There are now many versions of BASIC, developed from this original to run on modern microcomputers. Mallard BASIC is a powerful modern BASIC in a variety of versions, with many significant improvements, including the very unusual ability to access information stored on discs by using 'keys'.

To contrast with that, LocoScript is a word processor which is designed to require little if any knowledge to use. Word processors too come in many different varieties nowadays. LocoScript is unusual in that it combines powerful formatting capabilities with its what you see is what you get approach. Unlike some word processors, whenever you tell LocoScript how you want something layed out, it remembers. If you later change your text, you don't have to tell LocoScript again.

You can begin to use BASIC very quickly, as a sophisticated calculator, but more importantly, once you have learned how, you can use it to use and write BASIC programs.

Programs can perform an infinite range of tasks, from simple things such as totalling sequences of figures, to complex jobs such as maintaining a personnel file, calculating payrolls or performing statistical analyses.

You can use BASIC programs written by others (there is a very wide variety available), or use your own, once you have learned how to program.

BASIC is very versatile and can be used to perform most tasks that

You will notice that the text is laid out perfectly within your current margins. This is something that LocoScript does automatically for you.

The Textual Movement Keys

The first keys to learn about are the PCW8256's Textual Movement Keys: [CHAR], [WORD], [LINE], [EOL], [PARA], [PAGE] and [DOC]

[CHAR]

moves the cursor **through your document** character by character. When you try to use the Char key to move beyond the end of one of your lines of text, the cursor automatically moves to the first character of the next line.

[WORD] ([SHIFT] + [CHAR])

moves the cursor through your document word by word, the new cursor position being the first character of the next word. If you try to use the Word key to move beyond the end of one of your text lines, the cursor automatically moves to the first character of the first word on the next line.

[LINE] ([SHIFT] + [EOL])

moves the cursor to the first character of the next line.

[EOL]

when first pressed, moves the cursor to the end of the present line. If it is pressed again, the cursor moves to the end of the next line.

[PARA]

moves the cursor to the beginning of the next paragraph.

[PAGE]

moves the cursor to the first character on the next page. If your document is less than a page long, then this will take you to the end of the document.

[DOC] ([SHIFT] + [PAGE])

moves the cursor to the end of the document.

To get the above keys to work backwards rather than forwards through your document, you just hold down [ALT] at the same time as you press the key combination you would use to move forward. Thus:

[ALT] + [CHAR]

moves the cursor back through the document, character by character.

[ALT] + [WORD] (ie. [ALT] + [SHIFT] + [CHAR])

moves the cursor back through the document, word by word, the cursor always being positioned on the first letter of the word.

and so on.

The best way to become used to the way these keys work is to use them and so we suggest you spend some time doing this.

While you are doing this, also explore the effect of holding down [SHIFT] and/or [ALT] while pressing the cursor keys. With [SHIFT] the movements are in very much greater steps; with [ALT] it is the screen that moves, rather than the cursor.

Textual movement and editing

We have already seen that when we edit a document, the text frequently becomes wrongly laid out on the screen and how we could correct this by pressing [RELAY].

We will now see how a document can be re-laid simply by moving around it.

To get a suitable area of text, move the cursor to the first letter of LocoScript on the first line of the second paragraph and type in Locomotive Software's

```
To contrast with that, Locomotive Software's
LocoScript is a word processor which is designed
to require little if any knowledge to use. Word processors too come in
many different varieties nowadays. LocoScript is unusual in that it
combines powerful formatting capabilities with its what you see is what
you get approach. Unlike some word processors, whenever you tell
LocoScript how you want something layed out, it remembers. If you later
change your text, you don't have to tell LocoScript again.
```

The first thing to try is moving the cursor up and down, left and right between the two parts of the paragraph using the four cursor keys. Try this – the text remains unchanged.

With the cursor in the first part of the paragraph, now start moving it forward through the text using the Char key. Watch carefully what happens as the cursor moves into the area of the break.

```
To contrast with that, Locomotive Software's
LocoScript is a word processor which is designed
To contrast with that, Locomotive Software's
LocoScript is a word processor which is designed
To contrast with that, Locomotive Software's
LocoScript is a word processor which is designed
To contrast with that, Locomotive Software's
LocoScript is a word processor which is designed
To contrast with that, Locomotive Software's L
ocoScript is a word processor which is designed
To contrast with that, Locomotive Software's Lo
coScript is a word processor which is designed
```

Deleting sections of text

As you prepare a document, you will often want to delete everything from a short phrase to whole paragraphs. LocoScript provides you with a neat way of doing this called cut.

In all cases, the first thing you have to fix is where you want the cut to start. You have to be careful here because this point can't readily be changed. If you get it wrong, you can either cancel the cutting process or go back and change the text after the cut to correct for your error.

Move the cursor to the start of the section you want to remove and press [CUT]

Now move the cursor to the character **immediately after** the section you want to remove. Use the appropriate textual movement keys - [CHAR], [WORD], [PARA] etc. You will see LocoScript marking out the text, showing you what you are proposing to cut. If you overshoot, don't worry: as you move the cursor back, you will see the highlighted area shrink back to the cursor.

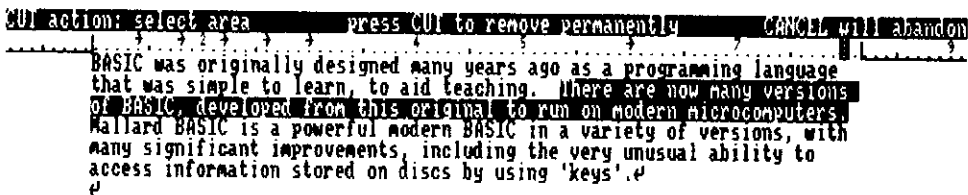

The screenshot shows a menu bar at the top with the following items: CUT action: select area, press CUT to remove permanently, CANCEL will abandon. Below the menu bar, a portion of a document is visible. The text "BASIC was originally designed many years ago as a programming language that was simple to learn, to aid teaching. There are now many versions of BASIC, developed from this original to run on modern microcomputers. Mallard BASIC is a powerful modern BASIC in a variety of versions, with many significant improvements, including the very unusual ability to access information stored on discs by using 'keys'." is highlighted. The cursor is positioned at the end of the highlighted text.

If you move the cursor back past the point you have marked as the beginning of the cut, the highlighting will still extend between this point and the current position of the cursor. Such a section will still be removed by the following steps of this cutting procedure.

When the cursor is correctly positioned at the end of the section to be removed, press [CUT] again. The highlighted text will be removed from the document and the screen should now look like this:

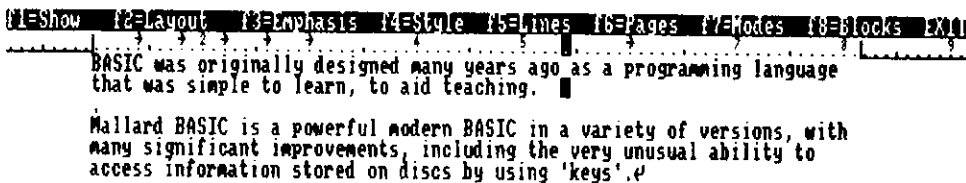

The screenshot shows the same menu bar as the previous image. Below it, the document text is shown with a gap where the highlighted text was removed. The text "BASIC was originally designed many years ago as a programming language that was simple to learn, to aid teaching." is followed by a blank line, and then "Mallard BASIC is a powerful modern BASIC in a variety of versions, with many significant improvements, including the very unusual ability to access information stored on discs by using 'keys'." The cursor is positioned at the end of the first line of text.

Don't worry that this has left some odd length lines. LocoScript will relay the paragraph either as you use the textual movement keys or when you type in new material anywhere further down the document.

Finding a particular point in the text

LocoScript also offers a particularly powerful form of textual movement through the **[FIND]** key.

When you press this key, LocoScript will prompt you for a short piece of text (not more than 30 characters) to find in the document. Type in the part of the text you want LocoScript to find, starting with the character you want the cursor to be left on. A few words will probably do. If your chosen piece contains any special characters such as `_`, you should include these.

If you make any mistakes in typing in this piece of text, move the cursor back over what you have typed and make whatever corrections are required. You do not have to delete characters back to where you made the mistake and type the remaining text from there. You can also use the **[]** key to clear from the cursor position to the end of the line.

When you have this 'find text' right, press **[ENTER]**. LocoScript then searches forward through the document, trying to match the find text against part of the document. If the text is found, the cursor is left on the first character of the phrase. If LocoScript doesn't find the text, it leaves the cursor at the end of the document.

If you use the FIND function again or if you have already used EXCHANGE (see page 71), LocoScript offers you the most recent 'find text'. If you want to use this text again, just press **[ENTER]**. If not, you can either edit it or type in a completely new find text. Clear the old find text by pressing the **[]** key.

Incidentally, the **[FIND]** key also provides you with a particularly quick and simple way of moving the cursor to the right places for marking the ends of a section of text you want to remove.

Suppose, for example, that you have moved the cursor to the start of the cut and pressed **[CUT]**. You now want to mark the end of the cut which you have decided should be just in front of the word 'computer'. What you do is press **[FIND]** and then type:

computer **[ENTER]**

The highlighted area will extend up to the start of the word 'computer'. If you now press **[CUT]** again, everything up to the beginning of 'computer' will be removed.

This method also provides a neat way of deleting the tail part of the current sentence, starting at the current position of the cursor. You just press: **[CUT]** (to start the cut), **[FIND]** (to start the search), `.` (to tell LocoScript to search for a full stop), **[ENTER]** (to confirm the search) and finally **[CUT]** (to carry out the deletion).

The text you have just deleted is gone forever.

Moving a section of text

LocoScript can also help you move part of the text from where it is at the moment to some new position in your document.

This time you will use the [COPY] and [PASTE] keys, as well as the [CUT] key.

Select some suitable few lines of the document on your screen to move.

The procedure is as follows:

Move the cursor to the beginning of the section you want to move (once again, check that you get this right - you can't change your mind, except by pressing [CAN] and starting all over again) and then press [COPY].

```
BASIC was originally designed many years ago as a programming language
that was simple to learn, to aid teaching. Mailard BASIC is a powerful
modern BASIC in a variety of versions, with many significant
improvements, including the very unusual ability to access information
stored on discs by using 'keys'.  
␣
```

Now move the cursor to the end of the section you have chosen. As before, this marks out a piece of text and if you overshoot, you can just move the cursor back to the right position.

Now press [CUT], followed by 0. The highlighted text disappears from the screen but, this time, it is remembered.

```
BASIC was originally designed many years ago as a programming language
that was simple to learn, to aid teaching.
, with many significant
improvements, including the very unusual ability to access information
stored on discs by using 'keys'.  
␣
```

Then move the cursor to the place you want this text to move to.

Press [PASTE], followed by 0, and the text is inserted in this new position.

```
BASIC was originally designed many years ago as a programming language
that was simple to learn, to aid teaching. . . with many significant
improvements, including the very unusual ability to access information
stored on discs by using 'keys'.Mailard BASIC is a powerful modern BASIC
in a variety of versions.  
␣
```

You can paste this text in again and again wherever you like.

However, we do recommend some degree of care in both choosing the text to move and where to paste it in. To see why, use exactly the same procedure again but this time move a section of text that finishes within some underlining. Move it anywhere you like and then press either [PAGE] or [DOC] to relay the whole page.

You could well have got an effect like this:

Before

To contrast with that, Locomotive Software's LocoScript is a word processor which is designed to require little if any knowledge to use. Word processors too come in many different varieties nowadays. LocoScript is unusual in that it combines powerful formatting capabilities with its what you see is what you get approach. Unlike some word processors, whenever you tell LocoScript how you want something layed out, it remembers. If you later change your text, you don't have to tell LocoScript again.¶

¶ You can begin to use BASIC very quickly, as a sophisticated calculator, but more importantly, once you have learned how, you can use it to use and write BASIC programs.¶

After

To contrast with that, Software's LocoScript is a word processor which is designed to require little if any knowledge to use. Word processors too come in many different varieties nowadays. LocoScript is unusual in that it combines powerful formatting capabilities with its what you see is what you get approach. Unlike some word processors, whenever you tell Locomotive LocoScript how you want something layed out, it remembers. If you later change your text, you don't have to tell LocoScript again.¶

¶ You can begin to use BASIC very quickly, as a sophisticated calculator, but more importantly, once you have learned how, you can use it to use and write BASIC programs.¶

The point is that the text is now laid out according to whatever word processing features are active at its new position. Moreover, if there are any word processing codes embedded in the text you move, it can change how the text that is 'left behind' is laid out as well.

If you are not sure why the move had the effect it had -- use the Show menu () to display all the word processing codes in their current positions.

Be prepared to insert whatever extra word processing codes are required to sort this out.

Copying a section of text

You can also use LocoScript to put an identical copy of part of the text in some new position in your document. The procedure for this is very like the Cut and Paste we did above; the difference is that this time we don't erase the piece of text we copy.

Select some suitable few lines of the document on your screen to duplicate.

The procedure is as follows:

As before, move the cursor to the beginning of the section you want to duplicate and then press .

Now move the cursor to the end of the section you have chosen and press [COPY], followed by 0. This time the highlighting disappears but the text stays there.

Then move the cursor to the place you want the copy of the text to be.

Now press [PASTE], followed by 0, and the text will be inserted at this new position.

You can paste this text in as many times as you wish, just like you could with the text you moved earlier.

Again, check that it is laid out the way you wanted it and you haven't caused any major changes to the text already there, and be prepared to put some more word processing codes in to get it right.

You may well have noticed that LocoScript has been offering you a choice of numbers between 0 and 9 at the top of the screen, while we have been setting up the text to move or copy. We explain why in Stage 7.

Exchanging one piece of text for another

So far, we have seen how to use LocoScript to delete a piece of text, to move it from one place in the document to another, and to produce a duplicate piece of text. Another option is to remove a phrase of old text and replace it with something new all in one action, possibly many times. This is done through another LocoScript function, EXCHANGE.

When you press the [EXCH] key, a menu appears on the screen with slots for the phrase you want to remove (up to 30 characters long) and for the phrase you want to replace it by (also up to 30 characters long). This menu also covers the various options for the exchange – confirming each exchange before it happens or automatically changing every example of the old text within a specified section of the document (the current paragraph, the current page or the whole document).

Type in the the phrase you want to remove (the 'find text'); then move the cursor down to the next line and type in the phrase you want to replace it by (the 'exchange text'). If these phrases contain any special characters such as _ , you should include these.

If you make any mistakes in typing in this text, move the cursor back over what you have typed and make whatever corrections are required. You do not have to delete characters back to where you made the mistake and type in the remaining text from there. You can also use the [] key to clear from the cursor position to the end of the line.

Now move down to the options part of the menu. Which option to select depends on whether:

- you want to confirm each exchange before this is made
- or you want LocoScript to go ahead and change every example in the rest of the current paragraph, the rest of the current page or the rest of the document.

'Confirm each exchange' is already selected for you, so if this is what you require, press **[ENTER]**. If you want one of the other options, move the menu cursor to the one you require (the / moves with the cursor) and then press **[ENTER]**. Alternatively, you can simply press the **[PARA]**, the **[PAGE]** or the **[DOC]** key. LocoScript will then proceed to search through the specified section of your document and make the exchange at each instance of the find text.

If you opt to confirm each exchange, LocoScript will put the cursor at the beginning of the first instance it finds of the find text and then wait for you to press a key. Press the **[↑]** key to make the exchange; press the **[→]** key to carry on to the next example.

If you want to cancel a multiple exchange part way through, just press **[CAN]**.

If you use the EXCHANGE function again or if you have already used FIND, the menu will come up on the screen with the most recent find and exchange texts already in. If you want to use these again, just select the type of exchange you want and press **[ENTER]** (or just press **[PARA]**, **[PAGE]** or **[DOC]**). If not, you can either edit the texts or type in completely new texts. Clear either of the old texts by pressing the **[←]** key with the menu cursor on that line.

Postscript

The operations we have covered here represent just a glimpse at some of the ways LocoScript can manipulate the text within your document. We look more closely at these in Stage 7.

Setting out text

The earlier sections of this User Guide have handled paragraphs of plain text, simply arranged on the page between margins that had already been set up. What we explore here are the facilities LocoScript has for handling tables and for laying out text precisely as you want it.

The key to most of these facilities is the combination of ruler and typestyle information that LocoScript knows as a Layout, and the options offered through the Layout menu. To show you how these work, we will edit another of the sample documents on your disc - QUOTE.EG.

If you are not sure how to bring this file onto your screen, turn back briefly to 'How to move about the screen' in Section 3.4.

Press **E** to start editing QUOTE.EG and then **[ENTER]** when you have checked that the document named in the Edit menu is the right one. Your screen should look like this:

```
F1=Show F2=Layout F3=Emphasis F4=Style F5=Lines F6=Pages F7=Notes F8=Blocks EXIT
-----
                                Quotation
┌
└
This quotation is for the supply of technical services and equipment and
is valid for 30 days. It is also subject to the following restrictions
and warranties.
┌
The company will not be liable for any delay caused by conditions out of
its direct control, nor will it accept liability for the failure of any
equipment except that directly attributable to the negligence of its
employees.
┌
The company warrants that the equipment is suitable for specific
workloads, and will hold the hirer responsible for any damage caused by
overloading.
┌
→ Hire of sanding machine, 5 days→ £10.30 per day→ £51.50→ LWR/BS
┌
→ Hire of carpentry shop→ £300.00→ £300.00→ CS/BS
┌
→ Consultancy, 7 hours → £25.00 per hr→ £175.50→ TYV/65
┌
We would wish to point out that the plans for the Gazebo you have
submitted to us are modified from the structural design we provided last
year. We therefore decline to quote for the further work in that area.
└
```

This is the text of a quotation for a job, which we want to make as professional in appearance as possible.

Indenting text

The second and third paragraphs are specific points you want to raise with your customer, so it might be an idea to label them 1) and 2). To make them stand out even more, we shall lay them out again further in from the margin.

What we suggest doing is putting 1) and 2) at the left margin but starting the paragraphs themselves at the first Tab Stop. (You will remember that a Tab Stop (-) marks the position the cursor jumps to when you press the [TAB] key.)

Move the cursor to the beginning of the first line of the second paragraph. Once there, just type 1) to put the label in and then press the Tab key to make the first word start at the Tab Stop. You will see the Tab symbol - appear where you pressed the Tab key.

To see what effect this has had on the paragraph, press [PARA].

```
FILE>Show  F2=Layout  F3=Emphasis  F4=Style  F5=Lines  F6=Pages  F7=Modes  F8=Blocks  EXIT
-----
                                     Quotation
                                     ^
                                     ^
This quotation is for the supply of technical services and equipment and
is valid for 30 days. It is also subject to the following restrictions
and warranties.
^
1) The company will not be liable for any delay caused by conditions
out of its direct control, nor will it accept liability for the failure
of any equipment except that directly attributable to the negligence of
its employees.
^
The company warrants that the equipment is suitable for specific
workloads, and will hold the hirer responsible for any damage caused by
overloading.
^
→ Hire of sanding machine, 5 days→ £10.30 per day→ £51.50→ LWR/85
→ Hire of carpentry shop→ £300.00→ £300.00→ CS/85
→ Consultancy, 7 hours → £25.00 per hr→ £175.50→ TYY/65
^
We would wish to point out that the plans for the Gazebo you have
submitted to us are modified from the structural design we provided last
year. We therefore decline to quote for the further work in that area.
^
```

While it looks quite good with the first line indented in this way, it is not the best we can do. What we would like is the whole paragraph indented.

To do that, we want - not a simple Tab on the first line - but what is called an Indent Tab.

Go back to the start of that paragraph and position the cursor over the -. Now press [DEL+] to erase the old tab and then press [ALT]+[TAB] to put in an Indent Tab on its place. You will notice that you now have a new character on the screen -. This is the Indent Tab symbol.

Next press [PARA] again to show you what effect this change has had. Your screen should now look like this:

Quotation

This quotation is for the supply of technical services and equipment and is valid for 30 days. It is also subject to the following restrictions and warranties.

1) The company will not be liable for any delay caused by conditions out of its direct control, nor will it accept liability for the failure of any equipment except that directly attributable to the negligence of its employees.

The company warrants that the equipment is suitable for specific workloads, and will hold the hirer responsible for any damage caused by overloading.

→ Hire of sanding machine, 5 days→	£10.00 per day→	£51.50→	LNR/85
→ Hire of carpentry shop→	£300.00→	£300.00→	CS/85
→ Consultancy, 7 hours	£25.00 per hr→	£175.50→	TYV/65

If it doesn't, check that the symbol you have after the 1) is a - and not a - ie. that you successfully swapped the simple tab for the Indent tab.

The paragraph is now exactly as if you had put a single Tab at the beginning of each line.

We would also like to have a similar layout for the next paragraph. We won't, for the moment, worry about the 2) that is to start it. First we want to see if the effect of the indent tab we put in at the beginning of the last paragraph carries on to this one: so press **[PARA]** again.

The answer, as you see, is 'No' because the Indent tab is cancelled by the carriage return at the end of the paragraph. So if you want to indent a series of short paragraphs in this way, you should insert an Indent tab at the beginning of each of them.

A paragraph doesn't have to be indented a single Tab: if you wish, you can arrange that the Indent Tab gives you more than one tab at the beginning of each line. All you need to do is to press the **[TAB]** key the appropriate number of times, holding down the **[ALT]** key as well for at least the last one.

Tables

Having tidied up that section of the quotation as much as we want, we now move down to the part of the letter where the costs of the individual components are itemised. What we need to do here is to add a new entry between the second and third lines because the cost of hiring a paint sprayer was missed out of the original quotation.

Move the cursor to the beginning of the third line and press **[RETURN]** to make room for the new line: then move the cursor back up to this new line.

The first thing to type is Hire of paint sprayer . Then we need to move across to the next column to put in what the hire charge is. Press the Tab key once: you will see that the cursor is now directly below the decimal point that divides pounds from pence in the line above.

```

f1=Show f2=Layout f3=Emphasis f4=Style f5=Lines f6=Pages f7=Nodes f8=Blocks EXIT
-----
caused by overloading.
+
+ Hire of sanding machine, 5 days- £10.30 per day- £51.50- LMR/85+
+ Hire of carpentry shop- £300.00- £300.00- CS/85+
+ Hire of paint sprayer- £25.00 per hr- £175.50- TTY/65+
+
+

```

Looking up to the ruler line, you will notice that the symbol the ruler cursor is on is • – reversed out because the cursor is over it. This is a Decimal Tab – a special form of Tab that allows you to line up the decimal points in a column of numbers.

The amount we want to type in here is £19.50 per day . Type this in quite slowly, watching what happens. The 1 first goes in just before the cursor and then is shuffled left as you type in the 9 . But when you type the decimal point, LocoScript immediately goes back to normal and puts in the remaining characters under the cursor as usual.

```

1=Show  2=Layout  3=Emphasis  4=Style  5=Lines  6=Pages  7=Nodes  8=Blocks  EX11
-----
caused by overloading.
^
→ Hire of sanding machine, 5 days→ £10.30 per day→ £51.50→ LMR/85¢
→ Hire of carpentry shop→ £300.00→ £300.00→ CS/85¢
→ Hire of paint sprayer→ £2
→ Consultancy, 7 hours £25.00 per hr→ £175.50→ TYY/65¢

```

```

1=Show  2=Layout  3=Emphasis  4=Style  5=Lines  6=Pages  7=Nodes  8=Blocks  EX11
-----
caused by overloading.
^
→ Hire of sanding machine, 5 days→ £10.30 per day→ £51.50→ LMR/85¢
→ Hire of carpentry shop→ £300.00→ £300.00→ CS/85¢
→ Hire of paint sprayer→ £12
→ Consultancy, 7 hours £25.00 per hr→ £175.50→ TYY/65¢

```

```

1=Show  2=Layout  3=Emphasis  4=Style  5=Lines  6=Pages  7=Nodes  8=Blocks  EX11
-----
caused by overloading.
^
→ Hire of sanding machine, 5 days→ £10.30 per day→ £51.50→ LMR/85¢
→ Hire of carpentry shop→ £300.00→ £300.00→ CS/85¢
→ Hire of paint sprayer→ £192
→ Consultancy, 7 hours £25.00 per hr→ £175.50→ TYY/65¢

```

```

1=Show  2=Layout  3=Emphasis  4=Style  5=Lines  6=Pages  7=Nodes  8=Blocks  EX11
-----
caused by overloading.
^
→ Hire of sanding machine, 5 days→ £10.30 per day→ £51.50→ LMR/85¢
→ Hire of carpentry shop→ £300.00→ £300.00→ CS/85¢
→ Hire of paint sprayer→ £19.5
→ Consultancy, 7 hours £25.00 per hr→ £175.50→ TYY/65¢

```

```

1=Show  2=Layout  3=Emphasis  4=Style  5=Lines  6=Pages  7=Nodes  8=Blocks  EX11
-----
caused by overloading.
^
→ Hire of sanding machine, 5 days→ £10.30 per day→ £51.50→ LMR/85¢
→ Hire of carpentry shop→ £300.00→ £300.00→ CS/85¢
→ Hire of paint sprayer→ £19.55
→ Consultancy, 7 hours £25.00 per hr→ £175.50→ TYY/65¢

```

```

1=Show  2=Layout  3=Emphasis  4=Style  5=Lines  6=Pages  7=Nodes  8=Blocks  EX11
-----
caused by overloading.
^
→ Hire of sanding machine, 5 days→ £10.30 per day→ £51.50→ LMR/85¢
→ Hire of carpentry shop→ £300.00→ £300.00→ CS/85¢
→ Hire of paint sprayer→ £19.502
→ Consultancy, 7 hours £25.00 per hr→ £175.50→ TYY/65¢

```

The same thing will happen when you press [TAB] again, this time to move to the column of total costs. The amount to type in here is £39.00 .

The last thing to type in on this line is the relevant reference code, which is LWR/85. Once again, press the Tab key: you will see the cursor is now directly below the `_` of the previous line.

Looking up to the ruler line, you will see that the ruler cursor is now over a `-` symbol. This is another special form of Tab, called a Right Tab, which allows you to line up the right hand edge of a column.

Now type in LWR/85, again quite slowly so that you can watch what happens. You will see the `_` appear first immediately to the left of the cursor and then get successively shuffled left as you type in the rest of the characters.

There is, in addition, a fourth sort of Tab called a Centre Tab, which ensures that everything you type in at that point is centred around the Tab point. This is represented on your ruler line by a `-`

Changing the Tab settings

The next job is to add the line at the bottom of this list that gives the total. We also want to put the word Total in to the left of the total figure `-` under the column of unit costs would do nicely.

To achieve this, we need to change the ruler line we have been working with slightly `-` removing the first decimal tab and putting in an ordinary tab in approximately the same position. That means changing the layout you are working with: the ruler line with its margins and tab stops is just part of a layout.

LocoScript works with a number of layouts, only one of which is active at any one place in your document `-` the Current Layout.

To change the ruler you are working with, you can either change the current layout `-` but that will affect **all** the text that has been laid out using that layout `-` or switch to using a different layout. This can be either a 'brand new' layout or one that you have set up before.

For now, we will create a new layout but, in future, you would be well advised to set up a few 'standard' layouts and work with these in a systematic way.

Although LocoScript can handle up to 99 layouts per document, it is normally set for a maximum of 5. When all available layouts have been specified, the option 'brand New Layout' will no longer be offered.

To create this new layout we need the Layout menu, which you will see from the top of your screen is called up by pressing function key `f2`.

With the cursor at the beginning of the blank line above the next paragraph, press `[f2]` (`[SHIFT] + [f1]`).

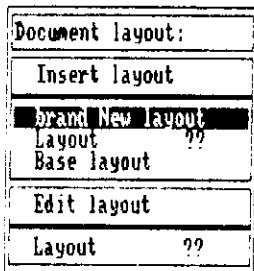

From the menu that comes up on the screen, select **Brand New Layout**. This tells LocoScript that you want to use a new layout because you don't want to alter the old one. So with the cursor on this line, press **[ENTER]**. This puts you into Layout Editing mode.

If you watch the screen while you do this, you will see that the top area of the screen changes, giving you a new set of actions that can be obtained by pressing the function keys. There is no Ruler cursor; however, a new cursor has appeared.



You will also see that the pattern of tab stops, etc. hasn't changed – even though you have asked to set up a brand new layout. This is because LocoScript gives you the old ruler settings as your starting point. This means that if, as in this case, you only want to make a small change, you don't have to set up the whole layout from scratch.

What you want to do is to insert a simple tab stop three columns to the left of the first decimal tab, which you then delete because you don't need it any more.

To do this, you need to press **[↑]** to move the cursor back down to the ruler line and then move it along the line to the place you want the new tab stop. Use the cursor keys in the usual way to do this.

Then press **[f3]** to insert a simple tab. The new tab stop (-) is now inserted in the ruler line.



Next, move the cursor a few places to the right to the decimal tab you want to delete. With the cursor over the decimal tab stop (*), press the **[↓]** key. The * immediately disappears.



This done, you are ready to leave Layout Editing and go back to editing the quotation document – so press **[EXIT]**. This puts you back into the document, precisely where you left it (ie. at the beginning of the paragraph after the table) though you will notice that LocoScript has put in an extra carriage return for you.

Press **[RETURN]** a couple of times to open up some space for the new line and then move the cursor back to just below the table.

```

caused by overloading.
↳
↳ Hire of sanding machine, 5 days→ £10.00 per day→ £51.50 LMR/85¢
↳ Hire of carpentry shop→ £300.00→ £300.00 CS/85¢
↳ Hire of paint sprayer→ £19.50 per day→ £39.00 LMR/85¢
↳ Consultancy, 7 hours £25.00 per hr→ £175.50 TTY/65¢
↳
↳ Total→ £566.00
↳
We would wish to point out that the plans for the Gazebo you have
    
```

Now press **[TAB]** twice to get in the right position for typing Total and then again to put in £566.00.

For a moment, look back at the ruler line and remember what it looks like. Now move the cursor slowly up the page and then down again. Notice the ruler line change. In particular, notice that the layout number on the middle information line changes.

The point here is that when you finished editing the layout, LocoScript did two things. The first was to store the new layout and give it a number. Each layout has a number: and the number of the current layout that is displayed on the screen.

The second thing LocoScript did was to put a mark in the document to tell it to change which layout it uses at that point. The old layout (ie. the one with the old ruler) is effective before the mark: the new layout after it. LocoScript also put in a carriage return so that you can start using the new ruler immediately; it is obviously impossible for LocoScript to use a different ruler until it goes on to a new line.

Just as you could use the Show menu to get LocoScript to display the codes used to underline text or make it bold, so you can use the same menu to get LocoScript to display where it changes to a different layout. In fact you can do this in two ways.

The first is, once again, to select the Codes option from the SHOW menu: this displays where you changed your current layout, along with all the other word processing codes.

The other is to select the Rulers option from the same menu. This gives you 'Ruler lines' in the middle of your document, identical in style to the one at the top of the page. These show you the layout that will be effective **below** that point in the document.

```

f1=Show f2=Layout f3=Emphasis f4=Style f5=Lines f6=Pages f7=Codes f8=Flags
-----
This quotation is for the supply of technical services and equipment and
is valid for 30 days. It is also subject to the following restrictions
and warranties.
1) The company will not be liable for any delay caused by conditions
out of its direct control, nor will it accept liability for the
failure of any equipment except that directly attributable to the
negligence of its employees.
2) The company warrants that the equipment is suitable for specific
workloads, and will hold the hirer responsible for any damage
caused by overloading.
→ Hire of sanding machine, 5 days→ £10.00 per day→ £51.50→ LMR/85
→ Hire of carpentry shop→ £300.00→ £300.00→ CS/85
→ Hire of paint sprayer→ £19.50 per day→ £39.00→ LMR/85
→ Consultancy, 7 hours £25.00 per hr→ £175.50→ TTY/65
-----
→ → Total→ £566.00
We would wish to point out that the plans for the Gazebo you have
submitted to us are modified from the structural design we provided last
year. We therefore decline to quote for the further work in that area.

```

If you like, you can always have these 'rulers' visible. You will certainly find this helpful when you want to set out complicated documents.

Changing the margins

The couple of short paragraphs below the costing outline the supplier's position on further aspects of the job. What we want to do here to make these stand out is to lay them out between narrower margins. Again we need a new ruler line and hence a new layout: so once more, press [`f2`] and select brand New Layout.

As before, the ruler line you are given as your starting point is the one you have just been using.

This time, all you are interested in is changing the margins so that you bring each of these in by five columns. You could delete the tabs on this ruler because you don't need them but there is no real point in this instance. We'll just change the margins.

To change the position of the left margin, first press [`.`] to move the cursor down to the ruler line, then use [`-`] and [`.`] to move the cursor to the new left margin position you want. Now look up to the information lines to see which key to press to mark this position as the new left margin. You should see the message `f1=Left Margin`. So press [`f1`] and the left margin will be moved to its new position.

Similarly, now move the cursor to the new position you want for the right margin. Looking up to the information lines, you should see `f2=Right Margin` - so press [`f2`] ([SHIFT] + [`f1`]). This moves the right margin to its new position.

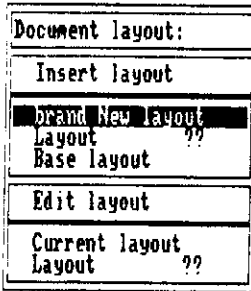

This time move the menu cursor to Layout ?? within the submenu and type in the number you noted down. Then press **[ENTER]**

If LocoScript recognises the layout number you have just typed in as one you have already used in the document, it will now return you to the text. If not (perhaps because you mistyped the number), you will be given a new layout with that number and identical settings to your present Current Layout.

To see what effect this has on the current paragraph, press **[RELAY]**

If you are still displaying the rulers used in the document, you will see that you now have a 'ruler line' inserted just before the cursor and that this has the same set of margins and tabs as the ruler you used higher up the text. This will apply all the way from immediately below this 'ruler' to the end of the document, unless you put in another instruction to change the layout.

Changing an existing layout

We mentioned earlier that one of the options LocoScript offers you in the Layout menu is to edit an existing layout. This can be either your current layout or some other layout that you have set up.

It doesn't matter whereabouts you are in the text when you call up the Layout menu to edit a layout – any changes you make will affect **everywhere** that layout is used. What is more, every piece of text affected which is before the current cursor position will be changed immediately you leave the Layout Editor. This takes a little time.

Most layout editing is done through the Layout menu. The exception is editing what LocoScript knows as its Base Layout – the one that it has stored in the document's File Header. When you need to edit the Base Layout, you will have to edit the File Header (see Stage 10).

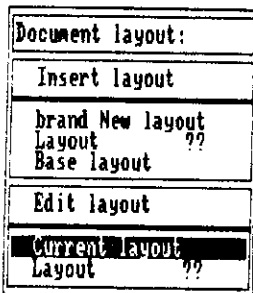

To edit one of the other layouts, call up the Layout menu (**[f2]**) and then use the Down cursor to move the menu cursor down to the section of the menu entitled 'Edit Layout'. The menu cursor moves directly from the upper part of the menu to the options listed in the lower part. Either select current layout or move to the other line and enter the number of the layout you want to change. Pressing **[ENTER]** puts you into the Layout Editor.

The procedures involved in changing the layout here are exactly the same as they were for setting up a new layout. Move the Layout cursor to the position you want the new margin/tab and press one of **[f1]...[f6]** to either move the margins or insert new tab stops: press the **[]** key when the cursor is over the tab stop you want to remove to delete it.

When you have finished editing the layout, press **[EXIT]**

Whenever you decide to change a layout, you need to remember two things:

- The fact that you have just edited the layout doesn't mean that you automatically go on to using that layout unless it is the current layout. For that, you have to call up the Layout menu again and specifically select this layout as your new current layout.
- Editing a layout affects the way your text is set out wherever that layout is used.

Postscript

So far, you have been working with the screen showing anywhere there is no text as well as typed spaces as spaces and all the places you have pressed the Return key or the Tab key by `↵`, `→` or `⇧`.

This was just how LocoScript was initially set up. You can, if you like:

- show anywhere there is no text by dots
- show up typed spaces as blobs
- stop showing carriage returns and tabs.

```
f1=Show f2=Layout f3=Emphasis f4=Style f5=Lines f6=Pages f7=Modes f8=Blocks EXIT
↵
↵ → Blanks shown by spaces, Spaces shown by spaces,
↵ → → Effectors shown by symbols
```

```
f1=Show f2=Layout f3=Emphasis f4=Style f5=Lines f6=Pages f7=Modes f8=Blocks EXIT
Blanks shown by dots, Spaces shown by spaces,
Effectors not shown.
```

```
f1=Show f2=Layout f3=Emphasis f4=Style f5=Lines f6=Pages f7=Modes f8=Blocks EXIT
Blanks shown by spaces, Spaces shown by symbols,
Effectors not shown
```

You can do any of these by calling up the Show menu (-f). Carriage returns and tabs are given the general heading Effectors

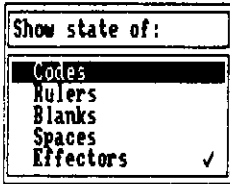

Anything you set by pressing the key will have a / next to it: to clear anything, press the key. When you have the combination you require, press ENTER : the new settings will have immediate effect.

These settings will stay in force as long as you wish. They are stored alongside the text when you finish editing the document, and so come back into play when next you edit that document.

Refining the appearance of the text

The appearance of a piece of text doesn't have to rely on just the margins and tabs that are set.

A word processor can do rather better than a typewriter in this respect: it gives you, for example, the option of using characters of different widths in different parts of the text and of making either the right or the left edge of the text beautifully aligned or ragged as you wish.

You can also centre each line of the text. Another choice you can make is between no hyphenation at the end of lines or hyphenation according to the rules you make.

All these choices are very easy to implement.

This chapter will show you how to ask LocoScript for the various options and what sort of results you can expect. There is a suitable sample piece of text to work with in the file LAYOUT.EG on the LocoScript disc.

After you press **E** (followed by **ENTER**) to start editing LAYOUT.EG, your screen should look like this:

```
f1=show f2=layout f3=emphasis f4=style f5=lines f6=pages f7=nodes f8=blocks LK11
-----
The care and feeding of your discs
This is a serious discussion of the finer points of discmanship by H J
Fisher. It should be read carefully.
Treat discs carefully and they will last you a long time. If you
foolishly pour coffee over them they won't! 3" discs come in a rigid
case which gives them added protection.
```

Centring text

You will often want to make a piece of text Centred – that is, with each line placed centrally between the right and left margins. This can be used for whole blocks of text but is most frequently applied to headings.

The menu we need is Lines, which you see from the information lines at the top of your screen is entered by pressing **f5** .

The document we have on the screen starts with a heading. So we shall centre that.

With the cursor on the first character of this heading, press [F5] to see the Lines menu.

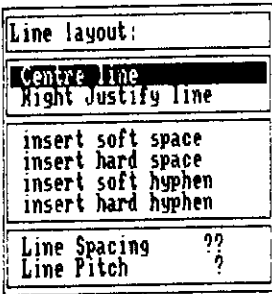

The option you want to select is Centre line, which you do by pressing [ENTER] while the cursor is on this option. You are then returned to the document.

You will see that the heading is now nicely centred.

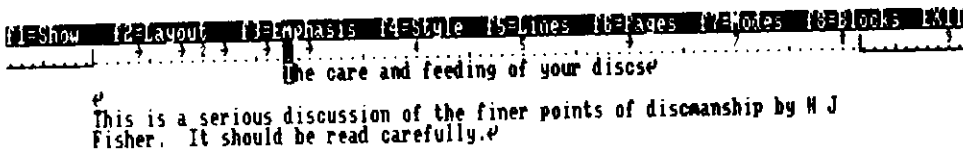

Now type [PARA] again. You might well expect this paragraph to have been centred as well but you will see that this is not the case. What has happened is that the Centring instruction has been cancelled at the end of the line with the code in it.

If you want a whole paragraph to be centred, you will have to move the cursor to the first character of each line and put in a Centring instruction.

Justification

If you wish to justify the whole document (or parts of it), you will need to alter the 'Document layout'. This is explained in the next section. Briefly, however, you may carry out full justification as follows. Position the cursor at the start of the text to be justified. Now press [SHIFT] together with [F2/F1] followed by [ENTER]. The menu cursor must then be moved to the word Justify, and the [] key (next to the space bar) be pressed. Finally, press [EXIT] to continue where you left off.

Right Justification

Unlike full justification, Right justification makes the right hand edge of the text straight but leaves the left hand edge ragged. To carry out Right justification, position the cursor at the start of the text to be justified and then press [F5] to bring the Lines menu onto the screen.

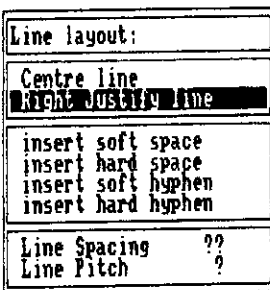

This time the option you want is Right justify line -so move the cursor to this line of the menu and then press [ENTER]. That puts the instruction in the text at the selected point and immediately moves all following words to the right hand end of the line.

The care and feeding of your discs

This is a serious discussion of the finer points of discmanship by H J Fisher. It should be read carefully.

Great discs carefully and they will last you a long time. If you foolishly pour coffee over them they won't! 3" discs come in a rigid case which gives them added protection.

Press [PARA] to see what effect the Right Justify code has on the rest of the paragraph. From this, you will see that Right Justify is another instruction that is cancelled at the end of the line with the code in it.

Using different character sizes

Another effect that you can readily use on your text is to change the width of the characters you use. This is known as changing their Pitch.

The true effect of changing the pitch is only seen when the document is printed out. On a screen, you are limited to a single character size but the other effect of changing pitch – changing the number of characters you can fit between the margins – is clearly shown.

LocoScript always shows you the line endings (and page endings) the document will have when it is printed.

The menu that helps you change the pitch is the Style menu, which you bring onto the screen by pressing [f4] ([SHIFT] + [f3]). As always, select the menu when the cursor is at the right place in the text. So start by moving the cursor to the beginning of a suitable paragraph.

The option you need from the Style menu is Pitch : moving the cursor to this and pressing the [-] key brings up the associated submenu.

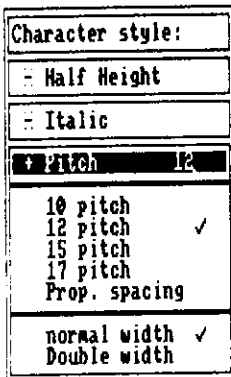

This allows you to select one of the five possible pitches – 10 pitch, 12 pitch, 15 pitch, 17 pitch and Proportionally spaced – together with the additional choice of normal width or double width.

Pitch is essentially the number of characters that will be printed in each inch of each line. So if you select 12 pitch, your text will be printed out with 12 characters every inch, while if you select 17 pitch, there will be 17 characters per inch.

Proportionally spaced text gives a document a very professional appearance. Instead of each character occupying the same space on a line, narrow letters such as *i* and *l* occupy a very much smaller space than wide letters such as **W** and **M**.

Punctuation marks, such as comma and full stop, also take up a lot less space. But so that tables of numbers are not distorted, digits and spaces are all the same width.

Overall, Proportionally spaced text occupies about as much room as it would in 12 pitch.

On top of these pitch options is the choice of normal width or double width characters. As the name 'Double width' suggests, each character then occupies twice as much space on the line – so this halves the number of characters per inch. So with both 12 pitch and Double width set, you will get just 6 characters per inch.

The pitch and the additional width option are selected separately. The current setting of each has a / beside it. If you move the cursor to another option and press the key, the / moves to the one you have just chosen. We suggest you choose 12 pitch and Double-width.

```
f1=Show f2=Layout f3=Emphasis f4=Style f5=Lines f6=Pages f7=Modes f8=Blocks EX11
```

In pitch 12

Treat discs carefully and they will last you a long time. If you pour coffee over them they won't! 3" discs come in a hard case which gives them added protection.

In Pitch 17

Treat discs carefully and they will last you a long time. If you pour coffee over them th 3" discs come in a hard case which gives them added protection.

In Pitch 10, Double width

Treat discs carefully and they will last you a long time. If you pour coffee over them they

↑
On the Screen
On the Printer
↓

In pitch 12

Treat discs carefully and they will last you a long time. If coffee over them they won't! 3" discs come in a hard case whi them added protection.

In Pitch 17

Treat discs carefully and they will last you a long time. If you pour coffee over them 3" discs come in a hard case which gives them added protection.

In Pitch 10, Double width

Treat discs carefully and will last you a long time you pour coffee over them won't.

When you have the combination you want, press **[ENTER]**. This puts a new pitch code into the text.

Now press **[PARA]** to see the effect it has. Press it again and you will see the next paragraph is also re-laid.

The pitch code is not cancelled by a carriage return. In this respect, pitch is just like underlining or boldening. In fact you may prefer to think of pitch as one of the emphasis effects.

As you will see, the right margin of the re-laid section of text is markedly different from that of the paragraphs above.

You will also notice that your ruler line has not been changed. This is because the ruler remains in the pitch you started in so that the margin and tab positions when the document is printed are maintained. Margins and tabs are recorded in terms of numbers of characters and the character pitch used to translate these numbers into positions across the page is the ruler pitch.

Keeping the ruler in the old pitch therefore ensures that the margins and tabs of your printed document will be consistent. However, while you are editing your document on the screen, the margins and tabs no longer line up with the markers on the ruler line and this can be confusing. You will need to be especially careful when adding new data to tables or when using the tab settings to create complex arrangements of the text.

Changing the pitch through the Style menu is the right approach if you want to use a different pitch temporarily for a particular section of your document. If you want to use a different pitch to that of the Base Layout for most of a particular document, you will want restore the alignment of margins and margin markers.

Document Layout

The way to restore the alignment of margins and margin markers is to create a layout set up properly for your chosen character pitch, just as we needed a new layout when we wanted to alter the margin and tab settings on the ruler line.

This time we focus on changing the parameters outlined in the second of the information lines. These include the size of the characters, how far apart the lines will be when your document is printed and whether each line will be justified (ie. aligned right and left).

The menu to use is again the Layout menu.

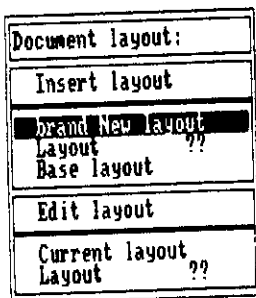

Once again, we have a choice of either changing the current layout – but that will affect **all** the text that has been laid out using that layout – or switching to using either a new layout or one that you have set up before.

If your current layout is the Base Layout (ie. the one first stored in the document's File Header), you won't be able to use the Layout menu to change it. You can only edit the Base Layout by editing the File Header (see Stage 10).

For now, we will create a new layout but, in future, you would be well advised to set up a few 'standard' layouts and work with these in a systematic way.

A new layout

The menu that comes up on the screen has two parts: the upper one, headed 'Insert Layout', deals with changing to the different layout; the lower, headed 'Edit Layout', with editing existing layouts. The menu cursor moves between the options under both these headings. Select brand New layout because you don't want to use or alter any of your current layouts. So with the cursor on this line, press [ENTER]; this puts you into Layout Editing mode.

Your starting point is, as always, the layout you have just been using so that if, as in this case, you only want to make a small change, you don't have to set up the whole layout from scratch.

Making changes

You may now use the cursor keys to move the 'Layout' cursor around the information lines, changing the values of the parameters as appropriate. Once you have put the cursor on a parameter you want to change, either type in the value you want or press either the [] or the [] key to step through the available options.

You could move the cursor down and change the ruler line, as we did before in Stage 3, but for now we will concentrate on the middle line – the other features of a layout. These are:

Pitch The options for setting pitch cover the whole range of 10, 12, 15 and 17 characters per inch, plus Proportionally spaced characters, together with the choice of normal width and double width characters. Changes made here affect both the printed text and the ruler. If you increase the pitch (ie. reduce the character width) without changing the settings on the ruler as well, the width of both the area to the left of the left margin and your printed line will decrease. You will see the opposite effect if you decrease the pitch.

Justify You can change between Justification On – ie. both edges of the text straight – and Justification Off – ie. just the left-hand edge of the text straight.

A document printed with Justification On can look very professional because LocoScript spaces the words out evenly along the line. This cannot be done precisely on the screen, but LocoScript produces much the same effect by inserting blanks between some words: these extra blanks show up as dots if the main background is dots but are blank if the background is blank.

Line Pitch and **Line Spacing** The Line Pitch (ie. the distance between consecutive lines) can be changed between 6 and 8 lines per inch; the Line Spacing (ie. whether you print on every line or every other line or...) can be changed to any of 0, ½, 1, 1½, 2, 2½ or 3. They are both more fully covered in Stage 5.

Italic When this setting is Off, your characters will normally be printed upright, but when this setting is On, they will normally be slanted.

When you have finished changing the layout, press [EXIT]. This both leaves editing the new layout and makes it your Current Layout. It will be used to lay out the last paragraph of LAYOUT.EG. To test the effect, press [PARA] and look back at the paragraph that gets re-laid.

Using an existing layout

You first make a note of the number of the layout you want to use. (Cursor up to a part of the document where you use this one if you don't already know its number.)

Then move the cursor to the line above the place you want to use this layout from and call up the Layout menu ([F2]).

Now move the menu cursor down to the Layout ?? line and type in the layout number you noted. Then press [ENTER]. LocoScript now inserts a Layout code into the document at the place you called the menu from.

Whenever the Rulers option of the Show menu is selected, the ruler part of this layout will be displayed **above the text to which it is applied**.

Editing a layout

The final option of the Layout menu is to edit an existing layout.

Editing a layout will affect any text in your document which uses this layout, and so should be used with care. Editing a layout does not insert a layout code – if you want to both edit a layout and make it the current layout you must use Layout ?? as well.

The Layout menu doesn't cover editing the Base Layout because editing this layout involves changing the document's File Header (see Stage 10). So if your current layout is the Base Layout, the option of editing the current layout is not included in the menu put up on the screen.

Line endings

The final refinement we can build into our documents is to make sure that the text always changes from one line to the next at a sensible place.

LocoScript normally only breaks a line at a space or at a hyphen within a word. This gives good results almost all the time.

But sometimes, especially when you are using very short lines or very long words, you can have a line where the space at the end of the line is so large that it looks ugly. Then you would prefer it if the first word on the next line could be hyphenated and split across the line break.

You could simply put a hyphen in where you would be happy for the word to break, but then you would be stuck with the hyphen when you decided to change the layout in some way.

Instead, you insert a special character into this word – one that tells LocoScript to display or print a hyphen only if the word is split between two lines. This special character is called a Soft Hyphen and it is inserted in the word at the point where you are happy for it to break.

To see this work, move the cursor back to the first paragraph and then to the first word on the third line of this paragraph. Choose the place in the word where you would like to make the break and then move the cursor to the first character after this break.

Now press **[fs]** to bring up the Lines menu.

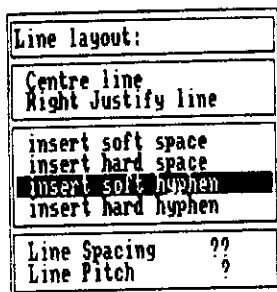

The option you want from this is insert Soft Hyphen . Move the cursor to this option and press **[ENTER]**. This puts the Soft Hyphen into the word and, provided there is enough space for the first section and the hyphen on the earlier line, LocoScript will immediately take this back to the previous line.

Now press **[PARA]** and see the rest of the paragraph re-laid.

If you later decide to change the margins or the character pitch, the hyphen won't show unless this word is again split between two lines.

The soft hyphen is a code just like the codes that are inserted in the document when you tell LocoScript to underline a particular section of text or make it bold. It will therefore be displayed as a code if you select the 'Codes' option from the Show menu and you can use the DEL keys to remove it if you decide you don't want it after all.

A similar case happens when your text includes, for example, a list of options separated by slashes such as French/German/Spanish/Danish. LocoScript treats this list as all one word, when you could quite sensibly split it after one of the slashes.

Once again, you solve this problem by calling up the Lines menu from the place you would like to split the list.

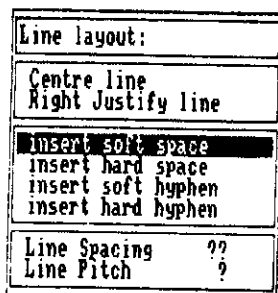

This time you won't want a hyphen at the break and so you use the insert Soft Space option offered in the LINES menu. The line will break, if it has to, at the soft space but there won't be a space between the parts of the list if they are all on the same line.

Another effect with automatic layout is that LocoScript might break a line somewhere you would rather it didn't. You may, for example, want to keep a particular pair of words together on the same line. Stopping the line from breaking in the middle of someone's name is a common example.

The solution to this problem is to make the space between words you want on the same line a Hard Space and to make any hyphen you don't want the line split at a Hard Hyphen. These tell LocoScript that the line cannot be broken here.

Hard Spaces and Hard Hyphens are real characters which you can either put in as you type in the text or use to replace existing hyphens or spaces – just like any other character. The menu they are obtained through is, once again, Lines.

To see how this works, move the cursor back to the first paragraph of the document where you will see the name H J Fisher has been split between two lines H J on one and Fisher on the other.

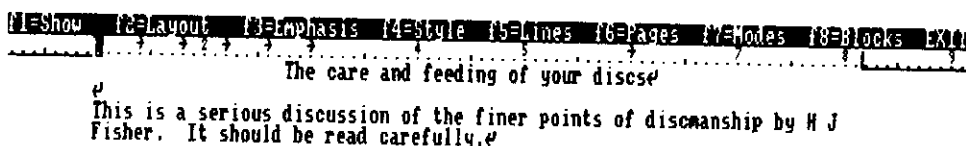

This is obviously not ideal. What we really want is the whole name on one line, and to do this we need to use Hard Spaces.

We will start by putting a hard space between the J and the Fisher . So move the cursor to two spaces after the J and press the [←DEL] key. That erases the normal space you had after the J . Now call up the Lines menu ([f5]) and select Hard Space.

Now press [RELAY] to relay this paragraph.

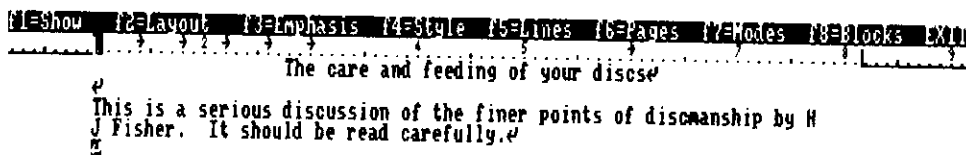

As you see, we still haven't got it right because we now have H on one line and J Fisher on the other. What we should have done was to replace the normal space between the H and the J with a hard space as well. If you now do this as before (this time starting with the cursor on the J), you will see that this **does** give you H J Fisher all on one line.

```
F1=Show F2=Layout F3=Emphasis F4=Style F5=Lines F6=Pages F7=Modes F8=Blocks EX11
.....
#
# The care and feeding of your discse
#
# This is a serious discussion of the finer points of discmanship by
# H J Fisher. It should be read carefully.
#
```

We suggest you spend some time trying out the effect of these various special characters.

Setting out pages

The changes we have made to the text so far have only affected how characters are set out on a particular line – its Horizontal Format. We have not thought about how the lines are set out on a page – its Vertical Format, – although this is obviously very important to the look of any printed document.

What is a page?

LocoScript divides each sheet of paper it prints on into three parts.

There is a short space at the top known as the Header Zone and a similar one at the bottom known as the Footer Zone. Between these two is the area of the page set aside for your text.

Left Margin

Right Margin

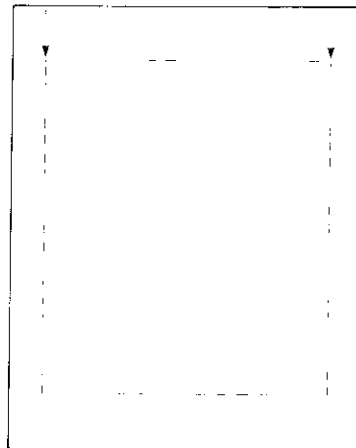

Header Zone

Text Zone

Footer Zone

The header and footer zones are rather like the left and right margins. Their main job is to ensure that none of your text gets printed either too near the top or too near the bottom of the page.

They can also be used for supplementary headings and for page numbers, giving your documents a really polished look, but for the moment we shall just leave them blank. We will show you how to add headings and page numbers in the next chapter.

Much of the time, you don't have to worry about how to set up suitable header and footer zones. Each document you create comes not only with suitable left and right margins but also with suitable header and footer zones.

In preparation for printing your documents out on sheets of paper, LocoScript also automatically divides them into pages. Each page of the document corresponds exactly with a sheet of paper. Anything that is shown on the screen as being on a different page will be printed on a different sheet of paper.

LocoScript shows you where the Page Breaks are by keeping the End of Page line between the bottom line of each page and the top line of the next. This line gives you an up to date record of both the number of lines used and the number unused on the page it finishes. Used lines are shown by the section to the left and unused lines (not displayed on the screen) are indicated by the central section of the line. The solid section to the right completes the line.

LocoScript does all its calculations in terms of the document's Base Line Pitch. Line Pitch is the number of lines LocoScript expects to print per inch of the page, and the Base Line Pitch is the value of this parameter that is specified in the document's File Header. The Base Line Pitch is usually 6 but it can be 8.

So if you don't change anything, your text will be printed out in lines that are 1/6in apart, with a short gap (the Header zone) at the top of the page and another (the Footer zone) at the bottom. The size of each gap is recorded as a certain number of lines in the Base Line Pitch.

The precise arrangement will depend on the type of paper you use, but if you use A4 sheets of paper, we have set up for you a gap of 1½ inches (9 lines) at the top and about an inch (7 lines) at the bottom.

However, you can readily use LocoScript menus to change this.

Changing the line spacing

Rather than print on every line, you might prefer to print on every other line. The parameter you set here is called the Line Spacing and setting its value to 2 gives you double line spacing just like setting the lever on a standard typewriter to 2. The full range of options is 0, ½, 1, 1½, 2, 2½ and 3.

Changing the line spacing changes the number of lines that go on one page. The bigger the line spacing, the fewer lines can fit on a page.

You can change the line spacing wherever you like within a document, and use it to great effect when the document is printed. The line spacing is always 1 on the screen, but that does not mean that the number of lines on a page will be wrong. LocoScript always gets the page endings in the right place.

You change the Line Spacing through the Lines menu ().

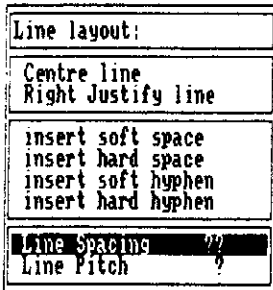

You first select Line Spacing and then type in the line spacing you want. Use the $\frac{1}{2}$ key if you want $\frac{1}{2}$, $1\frac{1}{2}$ or $2\frac{1}{2}$. Pressing returns you to the document.

Double line spacing is very useful for preparing the first few drafts of a document because it will leave you with plenty of space for marking corrections.

Zero line spacing means that lines are printed on top of each other but this can be useful if you want to print a complex piece of mathematics, for example, with both subscripts and superscripts at a particular position. Normally, you can only print **either** subscripts **or** superscripts at one place on a line.

Changing the Line Pitch

You could also change the Line Pitch in which your document will be printed at this stage, again using the Lines menu.

This also changes the number of lines that are printed on the page but in such a way that the End of Page line and the line number displayed at the top of the screen could be harder to interpret because these are worked out in terms of numbers of lines of the base line pitch.

Because of this, it is very much wiser to change Line Pitch only through the document's File Header (see Stage 10).

Where to start a new page

Having decided on the line spacing you want to use, you should then think about how paragraphs are split at the bottom of pages. Even if you don't mind if a paragraph is started on the bottom of one page and finished at the top of the next, you still don't want to have just one line of the paragraph on one page and the rest on the other.

- let LocoScript choose

In fact, LocoScript automatically prevents these 'Widows' and 'Orphans' from occurring by breaking one line early, so ensuring that you have at least two lines at the top of the second page.

However, you may well decide that you don't want a particular paragraph or part of a paragraph to be split across two pages. LocoScript helps you to ensure this doesn't happen by keeping groups of lines together. All you have to do is to ask for so many lines before or after a particular point to be kept together.

Having moved the cursor to the relevant part of the document, you call up the Pages menu by pressing **[F6]** and select the Keep lines together option. This asks you to type in the number of lines you want to keep together Above and/or Below this point in the text.

Just type in the number in the right place in this menu and then press **[ENTER]**. This puts a 'Keep code' into your document which tells LocoScript to keep the lines together. This is shown, along with all the other codes when you select the Codes option from the Show menu.

For example, you might have something like this in your text:

	Unit cost	Total cost
150 Keyboards	6.50	975.00
2000 Nuts	0.10 per 10	20.00
2000 Bolts	0.20 per 10	40.00

	Total	1035.00

This is six lines that you would be certain to want to keep together. To do this, you would move the cursor to either the top line of the group, call up the Pages menu and type 6 on the Below line of the menu, or move to the bottom line of the group, call up the menu and type 6 on the Above line.

If you accessed the menu from within the set of six lines - say, from somewhere on the third line - you would ask for 3 lines above and 4 lines below because the line you are on is counted both times. However, it is usually simpler to move the cursor to either the top or the bottom of the section you want to keep together and set up a single Keep code.

When LocoScript prints a document, it throws away any blank lines that it carries over from the bottom of one page to the top of the next. It will do this whatever the current depths of the Header and Footer zones.

This way you can be confident that you will have text on the top line of the new page. This is very much better than having to go through specially and remove the blank lines you put in between two paragraphs or part of a series of blank lines.

– or choose yourself

In addition to this, there will always be places in your document when you explicitly want to have a new page – for example, at the start of a new chapter.

You may think that the way to ensure this is to put in a number of blank lines at the relevant place, but in fact this is very much the wrong answer with LocoScript. Because LocoScript knows to throw away blank lines at the end of any page, it won't go onto the next page until you type the next line of text.

It is also the wrong answer from your point of view because the position this gives for the new page will not necessarily stay right when you make a change to the document or change the page size.

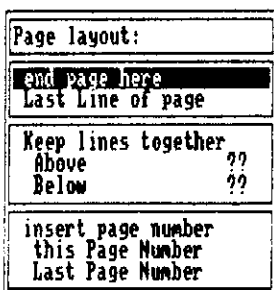

LocoScript gives you two possible ways of ensuring the next piece of text appears on a new page: you can either put an 'End Page here' symbol at the precise position you want the new page to start or put in a 'Last line of page' code somewhere on the line after which you want LocoScript to start a new page.

Both these options are accessed through the Pages menu ().



The 'End Page here' option gives you the proper solution to ensuring that a particular heading or paragraph starts a fresh page. Just put this symbol (␣), rather than a carriage return, on the line below the one you want as the last line. Then carry straight on with the first line for the new page.

The second option, 'Last line of page' is intended for the case when you want to break a paragraph at a particular point. You just insert this code somewhere on the last line before the break you want to make and the next line will always be printed on the top line of the next page.

In fact, you don't have to use the Pages menu to instruct LocoScript to 'End the page here'. You can also insert its code by holding down  and pressing .

Both these codes tell LocoScript to start a new page at this point whatever you have stipulated elsewhere about lines being kept together.

Position these codes carefully, because they override the LocoScript feature that ensures that text is printed on the top line of the next page. Indeed, if you did want to have a sequence of blank lines at the top of a page, the way to achieve this would be to put in an 'End of page' followed by the relevant number of carriage returns.

Making more fundamental changes

The remaining control you have over how your pages are set out is through changing your Base Layout. Changing the Base Layout can only be achieved by changing the File Header of the document you are working on.

Any alterations you make to the File Header should be carefully thought out in advance, because the File Header affects your whole document, not just the part after you decided to make the change. We describe editing the File Header in more detail in Stage 10.

However, there are a couple of parameters that are relevant here: these are Page size and Breaks. Page size covers the both the length of the page itself and details of the Header and Footer Zones; Breaks controls how paragraphs are split across page breaks.

The menu that gives you access to these parameters is Modes ([f]).

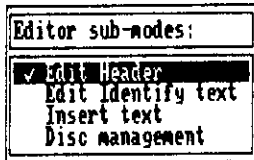

Selecting Edit Header from within this menu and then f7=Options, takes you back to the beginning of your document. It also changes the line of function keys so that they tell you what menus you can now call up. These refer to aspects of editing the File Header.

f1=Show f3=Emphasis f4=Style f5=Lines f6=Pages f7=Options f8=Blocks EXIT

—end of header 1 : used for all pages—

—end of footer 1 : used for all pages—

—end of header 2 : used for no pages at all—

—end of footer 2 : used for no pages at all—

Pressing [f] gives you the Page size menu.

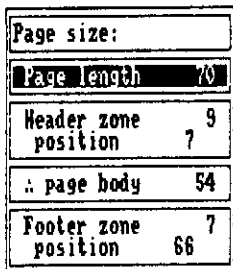

There are five pieces of information that LocoScript needs to set up a page for you. These are the Page Length, the depth of the Header Zone, the depth of the Footer Zone and the Positions for the top line of the Header text and the top line of the Footer text, both measured from the top of the page.

These pieces of information are all given in terms of numbers of lines in your document's base line pitch. This is usually 6 lines per inch and in the description that follows we assume that this is the case. If you have changed the base line pitch to 8, you should bear this in mind in working out the values to insert in the Page Size menu.

The Page size menu lets you change the current settings of these five page parameters.

To work out what values you want these to change to, take a sample sheet of paper and start by measuring its length in inches. Multiply by 6 and write down the nearest whole number to your answer. This is the maximum number of lines you could put on this page and it is what LocoScript calls the Page Length. If your paper is A4, the Page Length will be 70.

You now need to work out how much space you want to reserve for the Header Zone and the Footer Zone. If you plan to use single sheet stationery, remember that you will need to allow at least an inch (6 lines) above the Header text at the top of the page and half an inch (3 lines) below the Footer text at the bottom of the page. This is because the printer cannot grip the paper properly and print on these areas.

Suppose that you decide that your Header text will be just one line and it will be printed on the first possible line – that is line 1 on continuous stationery or line 7 on single sheet stationery. This line number is the value you need for ‘Header text position’. Draw a line representing the Header text on your sample page and write its line number beside it.

You then decide to leave two blank lines between this Header text and the top of your document text. If your Header text is on line 7, the blank lines would be lines 8 and 9. The value you need for the Header Zone is the line number of the last of these blank lines, ie. 9.

Now turn to the bottom of your page and the Footer Zone. It is usual for this to be a little smaller than the Header Zone and for the number of blank lines left between the bottom of your document text and the Footer text to be the same as that left between the Header text and the top of the document text. Suppose you decide to make the Footer Zone two lines less deep than the Header Zone: that would make the Footer Zone 7 lines deep.

You can now work out the line number of the last line of your document text. This will be the Page Length minus the Footer Zone: that gives a line number of 63 on our example A4 page. The two blank lines balancing those left at the top of the page will then be lines 64 and 65, making the line on which the Footer text will start – ie. the Footer text position – line 66.

At the end of this process, the numbers you might have are:

For single sheets of A4:

Page length:	70
Header Zone:	9 (must be 6 or more)
Header text position:	7 (must be more than 6)
Footer Zone:	7 (must be 3 or more)
Footer text position:	66

For 11inch continuous stationery:

Page length:	66
Header Zone:	5
Header text position:	4
Footer Zone:	7
Footer text position:	61

Note down the difference between the Page Length and the Footer text position and check before printing the document out that the Gap length you have set for the printer is not bigger than this number.

Compare your five numbers with the values currently displayed in the menu. Enter the changes in the appropriate slot of the menu, starting with the Page Length. As you change the values of the various parameters, the page body value will change and the word 'inconsistent' will be displayed if the text zone is reduced by your settings to zero. LocoScript will stop you from 'entering' any combination of settings that is inconsistent.

LocoScript won't insist that you position the Header and Footer text within the Header and Footer Zones but this is generally advisable. Otherwise, the whole text could be shifted down the page and you could lose the spacing between the Header and Footer text and the main body of your document.

However, if you are using Footer text such as 'contd' or 'ends' and you would like this to appear on the line immediately below the last line printed on the page, set the Footer text position to a low number such as 1.

A feature of LocoScript is that you can produce correctly paginated draft versions of your document on continuous stationery, with the Page Size parameters set up for the single sheet stationery you plan to use for the final version. The pages of the continuous stationery should be no more than one inch shorter than the single sheets. So if you intend to use A4, use 11inch or 11 $\frac{3}{8}$ inch continuous for drafting; if you intend to use A5, you could use 11inch, 11 $\frac{3}{8}$ inch or 8inch as you wish. You will, of course, have to ensure each time that you have set up the printer for the paper you are actually using (see Stage 8).

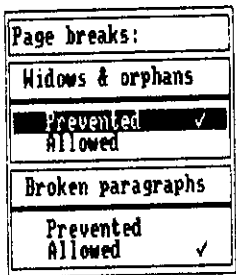

The Breaks menu (_{fb}) works like any other menu that gives you simple either/or choices. To select one of the two possible settings, you can either move the menu cursor to the one you want and press the key or move it to the one you don't want and press the key.

Preventing 'Widows and orphans' means that you never get just one line of a multi-line paragraph at either the bottom of one page or at the top of another. Preventing 'Broken paragraphs' means that a page break cannot occur in the middle of a paragraph.

Headings and page numbers

As we have already mentioned, LocoScript divides each page into three parts. There is a short space at the top known as the Header Zone and a similar one at the bottom known as the Footer Zone. And between these two is the area of the page set aside for your text.

Left Margin

Right Margin

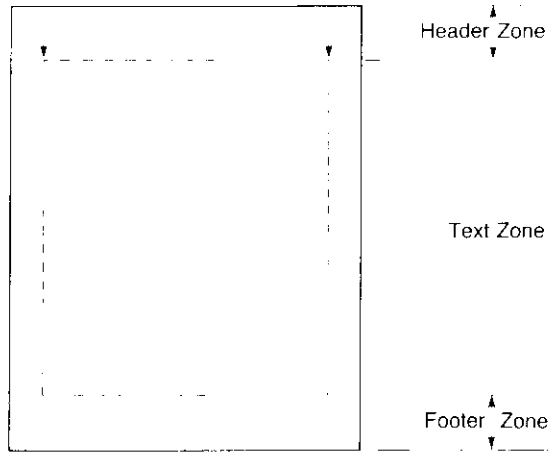

In this chapter, we describe how to put 'headings' and page numbers in either or both of the Header and Footer zones. We will demonstrate this by adding headings and page numbers to one of the sample documents – DOCUMENT.EG. This file should be called up onto the screen before you do anything else.

Setting up Headers and Footers

The first thing to decide about the text you use in the Header and Footer zones is whether you want to have the same texts on every page of the document. The other options are to have different text for odd and even pages, different text on the first page or different text on the last page to that you have on every other page. In addition, you can omit either the Header text or the Footer text from the first and/or the last page.

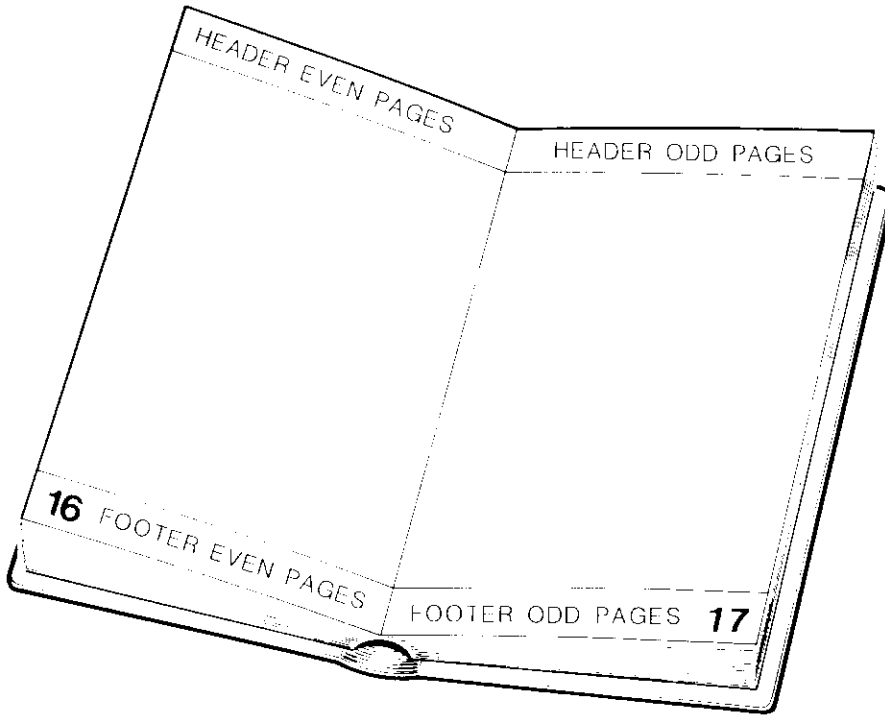

Details of the Header and Footer texts and how these are applied are stored as part of a document's File Header and the menu that helps you select from these options is the Pagination menu – one of the menus available to you when you edit the File Header. Call up this menu by first selecting Edit Header from the Modes menu (`[f]`) and then `f7=Options` to bring on screen the Header Editing functions. The Pagination menu is then brought onto the screen by pressing `[f8]`.

Pagination:	
first page number	↓
All pages same	✓
First page differs	
Last page differs	
Odd/even pages differ	
First page	
Header enabled	✓
Footer enabled	✓
Last page	
Header enabled	✓
Footer enabled	✓

The Pagination menu is split into four independent sections. The first section is there so that you can specify the page number the first page should have: the numbers for the other pages are then calculated accordingly. This feature is particularly helpful if you use LocoScript to prepare a book because it means that you won't have to keep all the chapters as one long document.

The second section covers where **different** Header and Footer texts will be used (if anywhere), while the third and fourth sections allow you to choose whether to leave off the Header text and/or the Footer text from the first and/or last pages, quite independently of any other decisions you have made.

Set up the features you want by moving the menu cursor to the appropriate line of the menu and pressing **[+]** to select (enable) a particular option or **[]** to clear (disable) a previous setting. If you want the first page number to be different, move the menu cursor to the First page number line and type in the number you want, followed by **[ENTER]**. The biggest number this page (or any page) can have is 9999 .

Which options to select is best illustrated through a few examples.

Suppose your document is a chapter in a book. In this case, you will probably want to set the first page number so that it follows on from the previous chapter. You are also likely to want different text on odd and even pages and to omit the Header text from the first page (ie. the Header and Footer both enabled on the Last Lines page but just the Footer enabled on the first page).

For a long formal report, you are likely to want most of the pages to have 'contd' at the bottom of all pages except the last, which should finish with the word 'ends'. The option to use is 'Last page differs'.

You should also choose this option for letters that may run over more than one page. A multi-page letter could then have the appropriate continuation Header and Footer text, with for example 'contd' at the bottom of the first page, but some appropriate finishing Footer text at the bottom of the last page.

A single-page letter would still have the appropriate finishing Footer text at the bottom of the page because LocoScript arranges that the Header text on a single page document will be the one for a first page and its Footer text the one for a last page.

Once you have made your selection, you will want to set up the texts themselves. This is done on a special four-sectioned screen that appears after you leave File Header editing and confirm that you want these changes made. It also appears on selecting 'Edit Header' from the Modes menu (**[fr]**). If some Header and Footer text has been set up already, this will be displayed on this 'Pagination' screen.

```
F1=Show F3=Emphasis F4=Style F5=Lines F6=Pages F7=Options F8=Blocks EXIT
-----end of header 1 : used for all pages-----
-----end of footer 1 : used for all pages-----
-----end of header 2 : used for no pages at all-----
-----end of footer 2 : used for no pages at all-----
```

The messages incorporated into the lines dividing up the screen tell you how the piece of text inserted above will be used, based on the current settings in the Pagination menu. If you change from, say, odd and even pages different to a different first page, the messages on the Pagination screen will change but the texts will stay the same. In this particular case, what had been the texts for odd pages become the texts for the first page and those for even pages, the texts for the remaining pages.

Preparing and editing these texts (Pagination editing) is similar to preparing and editing a document. You can use all the effects of underlining, bold, italic, different character pitch etc. and most of the functions that help you prepare the text normally still work here. However, the only layout you can use here is the document's Base Layout.

On top of these, you can now use some new codes. These are specifically intended to help you position page numbers precisely where you want them. What these are and how they work is best described through setting up some sample Header and Footer text, so let's set about making 'Commercial Software for the PCW8256' (centred) the text to go in the top section of the screen and the page number (also centred) the associated Footer text.

To get the heading in, we first put in a text centring code using the Lines menu (f5) and then type in:

```
Commercial Software for the PCW8256
```

That's set up the heading.

Now move the cursor down to the top line of the second section. Our aim here is to put in the page number neatly centred, both on the line and between a pair of hyphens so that you will get - 1 -, - 2 -, etc. (- 1 -, - 3 - if you opted for different odd and even pages).

To do this, we want to first put in a text centring code as for the heading at the top; then the first hyphen. What comes next is the page number code.

The first part of this to put in is a 'This page' code. The menu that helps you insert this is the Pages menu, so press [f6].

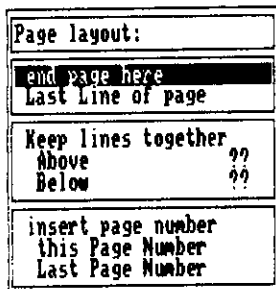

Then move the menu cursor to This Page number and press ENTER . The correct code is now inserted in the Footer zone text.

Now you have to tell LocoScript how much space you want to allow for the page number. You have to tell it this or no number will be printed.

What you do is to type one of three possible symbols **as many times as the space you want is columns wide.**

The symbols you use also tell LocoScript whether you want the number to the left of this space, to the right of the space or in the middle. If you use the centre symbol, the page number will still be centred whether it is just one digit (1...9), or two digits (10...99), or three digits...

The symbols are:

- < If you want the number to the left
- > If you want the number to the right
- If you want the number to be centred

We have already chosen to centre it and we will make the total gap four characters wide. So the next thing to type is:

====-

And that's the page number in place, the final hyphen balancing the one we put at the beginning.

When you set up Header and Footer text for real, you would now insert similar text in the lower two sections of the screen – unless you opted to have the same texts on every page.

Another option LocoScript gives you is to number the pages as 'Page 1 of 4', 'Page 2 of 4', etc. where in this example the whole document is four pages long. An example where this is used is the 'template' called MANUSCRP on Side 1 of your LocoScript disc.

This style of page numbering requires a Footer text with **two** groups of '<'s, '>'s or '='s. The first group is preceded by a 'This page number' code and the second group by a 'Last page number' code. Both these special codes are inserted with the help of the Pages menu. Once again, remember to put in appropriate numbers of '<'s, '>'s or '='s to reserve the space in the Footer text for the numbers.

The end result

When you have finished setting up these texts, press [EXIT].

The EXIT menu from Pagination editing gives you four choices:

Using the pagination text you have just set up and returning to working on your document;

Rubbing out all the changes you have made to this text since calling up the Pagination screen and starting again;

Rubbing out all the Pagination text and starting again; and

Abandoning the edit altogether. This throws away all the changes you have made to the document and its File Header since starting the current edit, and returns you to the Disc Manager screen.

The first of these will be your most common choice and it is already selected for you when the menu appears. If you want one of the other options, move the menu cursor first – but otherwise, just press **[ENTER]**. That takes you back to your document.

If this is the first time you have used Header and Footer texts, we suggest you finish editing your document, load some paper into your printer (if necessary) and select Save and print from the EXIT menu. (If you are not yet confident about printing out documents, turn to Stage 8 and follow the instructions given there.)

You will see that the texts in the Header and Footer zones are totally independent of the word processing codes being used in the document itself. These are temporarily suspended while the Footer Zone text is being added to one page and the Header Zone text to the next. The document then continues, independent of the Header and the Footer. There is no risk of the Footer text being affected because the last line of the document on one page is underlined or bold, for example.

Cutting and pasting

When you are preparing a long document – say, an article for a magazine or a report for your client or your manager – you will frequently find yourself wanting to change the order of whole sections of the text.

How to approach this problem is just an extension of the moving sections of text from one place to another that you have done before.

You will remember that the procedure to move a piece of text was to move the cursor to the beginning of the piece of text; press **[COPY]**; move the cursor to the end of this section; press **[cur]**, followed by **0**; move the cursor to where you want the text to go in; and press **[PASTE]**, followed by **0**. You will also remember that the section of text was temporarily deleted from the document.

What actually happened was that this section of text – including any embedded layout and word processing codes – was moved into a Block, and when you pressed **[PASTE]**, the contents of this block was 'pasted' into the document.

Similarly when you duplicated a section of text, what happened was that a copy of the section you marked out was put in a block. Again pressing **[PASTE]**, pasted the contents of the block into the document.

LocoScript has a total of ten such blocks, numbered 0..9. The one we used was Block 0 – that's why we followed both **[CUT]** and **[PASTE]** with a **0**. But we could just as well have used any of the other nine blocks.

There was also no need to paste the text back into the document immediately. The text remains in the block until it is replaced by something else or you finish editing the document. You can therefore paste it into the document as many times as you wish.

So if you want to really chop your document around, fill up as many of the ten blocks as you need and then paste the pieces of text back in in whatever order you want. You will find this very much more efficient than making the moves one by one.

To see how this works, edit DOCUMENT.EG, which is one of the sample documents that were provided on Side 1 of the system discs.

Now use [COPY] and [CUT] to remove three paragraphs from this document and put each in a separate block, say Blocks 1, 2 and 3. Press [COPY] with the cursor at the beginning of the paragraph you plan to remove, then cursor to the end of the paragraph and press [CUT] followed by the number of the block.

Now paste them back in the document wherever you like in the order Block 2 first, then Block 3 and finally Block 1. Each time, just move the cursor to the place you want the paragraph to go in and press [PASTE], followed by the number of the block holding it.

Maintaining your blocks

If at any time you want to see which blocks you have something stored in, you can do this through the Blocks menu ([fo]).

Text storage:
Block
Save block
Phrase ABCD X M P RS Z
Save all phrases

The top section of the menu lists the numbers of the blocks that have text stored in them.

This menu also offers you a way of saving blocks as separate documents for use in subsequent document editing. Unless you explicitly save a block, the text from it will be lost when you finish editing the document.

If you want to save a block, select the Save block line from the Blocks menu and type in the number of the block you want to save. Then press [ENTER]. LocoScript will respond by putting up the Disc Manager screen and asking you for a filename for this block. You can use the Group and File cursors in the usual way to pick out where you want to store the new document.

Then all you need to do is follow the instructions to save the block that you want as a new document. Press [ENTER] when you have finished setting up this information.

Blocks that you save in this way can be pasted into documents by using the 'Insert text' facility (see below) just like other documents, but they cannot be edited.

Pasting in whole documents

While you are editing a document, you can paste in

- one of the other documents you have stored:
- a block that you saved in an earlier editing session; or
- an ASCII text file initially prepared under CP/M.

You can paste in any document or file wherever you like and as often as you like. The process of pasting in does not erase the original copy.

Call up the Modes menu (\overline{F}) from the point in the document where you want to paste in this external text and select 'Insert text'. This displays the Disc Manager screen so that you can use the File Cursor to pick out the document or file you want to paste in.

Press \overline{ENTER} . LocoScript then puts up a menu that gives you the chance to change the details of the document/file to be pasted in. The process of pasting this document in begins when you press \overline{ENTER} to confirm these details.

LocoScript recognises stored blocks, phrases and LocoScript documents, but assumes anything else you paste in is an ASCII text file. You will quickly know if you are pasting in a program file, for example, because the screen will start to fill with apparently meaningless characters. If this happens, press \overline{STOP} twice to stop more of the file being pasted in.

The layout of the block, document or text file after it has been pasted in will, of course, depend on the document you paste it into and whereabouts you insert it. In particular, any changes of layout and tabs will be interpreted according to the layouts stored in the document's File Header. This will never be a problem if you have a consistent approach to layouts.

Using phrases

A similar facility LocoScript has is to allow you to paste in up to 26 short phrases. The phrases are known as Phrases A..Z. As you prepare your document you just press \overline{PASTE} , followed by a letter, instead of typing in the whole phrase.

Phrases are more useful than Blocks for a number of jobs, firstly because there is a simple procedure for keeping them up to date and, secondly, because they are always available to you. Phrases held in a special file called PHRASES.STD on your Start of Day disc are loaded into the PCW8256's memory along with the LocoScript software and you can change or add to these phrases as you edit documents.

Side 1 of your system discs has a PHRASES.STD file with a few phrases in it for you to experiment with. Try, for example, moving to some appropriate place in DOCUMENT.EG and pressing \overline{PASTE} followed by Z.

Setting up phrases

You set up Phrases in exactly the same way as you set up blocks. You mark the beginning of the phrase you want to save by pressing \overline{COPY} and mark the end of it by pressing either \overline{COPY} or \overline{CUT} , depending on whether you want to leave it in your document or erase it. The difference is that, instead of then typing a digit, you type one of the letters A..Z.

These phrases will be particularly helpful to someone like an estate agent preparing details of a number of houses. Much typing would be saved if phrases like 'Within easy access of all local amenities' and 'Gas fired central heating' could be inserted in the details by just pressing **[PASTE]** followed by the appropriate letter.

You can't always use all 26 of these phrases. Individual phrases can be up to 255 characters long but their **total** length is limited to around 550 characters.

If you type the letter of a Phrase that is already being used, you will overwrite the text stored there. If that text hasn't been stored in the PHRASES.STD file, then it will be lost for good.

You can overwrite a phrase that was set up from the PHRASES.STD file and the new phrase will be used from then on. It doesn't affect what is stored in PHRASES.STD and so the 'old' phrase will be restored when you reset the PCW8256.

Try setting up some new Phrases. We recommend that you start by storing something short in Phrase Z because the phrase that is stored there at the moment takes up quite a lot of your allocation of 550 characters.

Maintaining your phrases

You can always find out which Phrases currently have something in them through the Blocks menu (fe).

Text storage:	
Block	
Save block	
Phrase	ABCD K M P RS Z
Save all phrases	

The part of this menu referring to Phrases works very much like the part that refers to Blocks. Thus the Phrases line of the menu carries a list of the Phrases currently in use.

The other line is the key to either creating or modifying your PHRASES.STD file. Selecting 'Save all phrases' automatically creates a special file called PHRASES.STD in the first group on Drive M (replacing any existing PHRASES.STD file there). You are returned almost immediately to editing your document.

If this set of phrases is to be available in future editing sessions, this file has to be moved to the first group on your Start of Day disc. It will then be read into the PCW8256's memory at the same time as the LocoScript software. Erase any existing PHRASES.STD file on your Start of Day disc and then move the new file across as soon as it becomes convenient.

Printing

LocoScript offers you two types of printer action – one where the job is to print out a copy of the document you have prepared on your PCW8256 and the other for when you want to use the system as a Line-by-Line electronic typewriter, for example to fill in a form. This second option is referred to as Direct Printing.

Printing your documents

Printing out even quite complex documents under LocoScript should always be a simple matter.

You can start printing either from the menu of options you are offered when you finish editing a document or from the Disc Manager screen. In the first case, the document you print is the one you have just been working on; in the second, all you should need to do is to move the File Cursor to the document you want to print, press **P** and then **[ENTER]**. You can then turn attention to editing some other document while this one is being printed.

The only other things you need to pay attention to are loading paper into the printer, making sure that the printer is set up properly for the paper you want to use, changing the quality of the printing between 'High quality' (suitable for business letters) and 'Draft quality', and releasing the last sheet of paper printed on.

If you are ever unsure how to load paper into your printer, turn to Appendix II where loading the printer is described in detail.

The Printer Control State

The other printer operations all become possible when the PCW8256 is in its Printer Control State. It enters this state either when you press the **[PTR]** key or when you operate the Paper Load Knob on the printer.

The PCW8256 also puts itself into Printer Control State while you load and adjust fresh sheets of paper.

Going into Printer Control State halts printing. This means that if the paper becomes caught in the printer, you can quickly stop printing by just pressing the **[PTR]** key.

If the printer is in the middle of printing out some text when you press the [**PR**] key, it will halt as soon as it is finished either printing the current line or moving the paper to the next print position.

The top line of your screen now tells you about the state of the printer. It tells you, for instance, that the printer is On-line (ie. ready to print) or that it is Off-line (ie. on stand-by). It will also tell you whether it is currently printing or that it is idle.

The next line down shows you the keys to press to make particular changes to the printer state. Most of these put up menus on the screen from which you can select options or initiate actions, just like you can from any other LocoScript menu. Press [**ENTER**] to confirm; [**CAN**] to abandon. The exception is [**fe**] which switches between On-line and Off-line whenever it is pressed.

```
Printer: Online Top of form Idle High quality Single sheet
f1=Options f2=Paper f3=Actions f5=Document/Reprint f7=Reset f8=On/Off Line EXII
```

Options	
High quality	✓
Draft quality	
Single sheet paper	✓
Continuous stationery	
Form length:	70
Gap length:	3
Paper out defeat	✓

f1-Options The options available through this menu cover the quality of print, the type of stationery you plan to use and at what point the PCW8256 signals that it is out of paper.

The choice of print quality is between professional High quality printing and the quicker Draft quality that you would typically use to check that your document is how you want it. Obviously, you must have one or the other of these options and so setting Draft quality, clears High quality and clearing Draft quality, sets High quality.

Single sheet or continuous stationery is another either/or choice. Moreover, if you select Single Sheet, all the rest of the settings will be automatically adjusted to those needed by A4 paper – ie. 70 lines to the page, a gap of six lines at the top, a gap of three lines at the bottom of the page and no special signal at the end of the page.

Similarly, selecting Continuous automatically adjusts the settings to those needed by standard 11inch continuous paper – in particular, 66 lines to the page and a gap of five lines at the perforations. This, in fact, gives you the same number of print lines on 11inch continuous stationery as on A4 single sheet.

Any additional settings you want to change, you alter through this Options menu. Note that the length of each sheet of paper is measured in 1/6ths of an inch (ie. it is the maximum number of standard lines that can be printed on the page), and the length of the gap you want left at the bottom of each sheet of paper is again given as a number of standard lines. Making sure that these parameters are set correctly is very important.

Paper out defeat is used to prevent the printer automatically stopping when it detects that it is nearing the bottom of the paper. When this option has a / beside it, the printer won't stop.

Normally you will want to select this option when you are using single sheet stationery (because you want to use its full length) but not when you are using continuous stationery (because you will often want to leave a long print-out unattended).

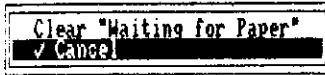

f2—Paper This menu is used to take the printer out of its Waiting for Paper state.

When printing on single sheets of paper, LocoScript will wait at the end of each sheet of paper for you to insert the next sheet. Inserting the new sheet will normally let LocoScript continue printing once you leave Printer Control State. You will only need the Paper menu if this is not the case.

It is possible for the printer to be waiting for paper when there appears to be lots of paper waiting to be used. What is likely to have happened here is that you are using continuous stationery while the printer is still set up for single sheets of paper: put this right first. Alternatively, you could have inserted the paper into the printer without using the paper load mechanism.

Pressing **[ENTER]** will clear the Waiting for Paper state.

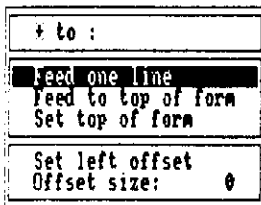

f3=Actions This menu enables you to release the current sheet of paper (by selecting Feed to top of form) and to set the position of the left hand edge of the printed document relative to your sheet of paper (the Left Offset). It is also used when you are using continuous stationery to tell the printer that the current print position corresponds to the Top of Form, ie. the level on the page at which the first line will be printed.

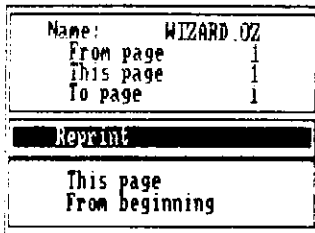

f5- Document/Reprint This menu has two roles. It gives you access to details of the document that is being printed and it enables you to reprint pages if the paper gets mangled in the printer for some reason while you are printing the document. Turn to Appendix I for advice on how to get paper passing freely through the printer again.

The Reprint part of the menu gives you three choices, once you have sorted out the paper in the printer. You can either start printing again at the top of the page it was printing when you stopped it, or you can start at the top of the previous page, or you can start all over again.

Move the menu cursor down to the option you require and press the **[+]** key. You will be prompted to ensure that the next print position is at the top of a new sheet of paper before continuing. Do this before pressing **[EXIT]** to leave Printer Control State and continue printing.

If you decide to reprint from the top of the previous page and the paper becomes mangled again almost immediately, you will only get the first and third of these options when you try again. You can't go back and print the page previous to that one.

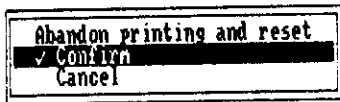

f7 = Reset This menu enables you to reset the printer. This option is used only rarely.

It is also used to abandon printing, if required.

f8 = On/Off Line Pressing **[f8]** switches between these two states of the printer.

The printer must be On-line to print. If you want it to stop printing while you do something else, you will normally just press **[PTR]** to put the printer into Printer Control State.

However, it will automatically start printing again when you leave Printer Control State. If this is not what you want, you should put the printer Off-line.

When you are ready to go back to printing, press [EXIT]

Once all the various settings have been made, there is only one way in which your document might not come out right – the text could be wrongly positioned on the page.

This indicates that the physical dimensions of the paper you are printing on are different from the dimensions you told LocoScript when it was laying out and paginating the document.

If the paper the document was laid out for was smaller than the paper you are using, then you should be all right: the printer will just print everything towards the top and to the left of each sheet of paper.

But if the paper you are using is the smaller one, you could have a relatively poor result, with text for one page spread over two or more sheets of paper.

Either change the paper you are printing on, or edit the document so that it has the correct layout and pagination (see Stage 10).

Direct printing

LocoScript's Direct Printing mode allows you to type in and print text line by line. This is useful, for example, for filling in forms. It is one of the options you are offered from the Disc Manager screen. The key to press is **D**.

What happens when you press **D** is that a short menu is put up, asking you to confirm that you want the Direct Printing feature by pressing **[ENTER]**. Then the screen changes to the usual editing screen and you can type in text in the normal way.

But instead of waiting for you to complete the whole document before printing it, what you type in is printed part by part as you press the Return key. It then is erased from the screen: your document never gets stored.

The advantage of this mode of operation is that you can pause between lines, as and when you wish, and reposition the print head so that the next line will appear on the page in exactly the place you want it. (We will tell you how to do this shortly.)

However, you can only correct the text you have on the screen, just like a line-by-line electronic typewriter.

All the word processing actions that you use on your other documents are still available to you. You can underline words, print them in bold script, change the pitch, centre text or right justify it as you will.

In particular, you may find it useful to set the line spacing to 0 when you are filling in especially complex forms, as then you can set up the individual entries on a line separately and not worry either about their spacing or about getting them properly aligned.

Another setting you might consider is that of the right margin so that there is no danger of printing too far over to the right.

The key facility LocoScript gives you is that of setting the Left Offset for each piece of text you type in. The Left Offset determines where the first character of the text will be printed. The ruler LocoScript gives you to set up the text has the left margin at the left-hand edge of the screen to help you make best use of the Left Offset facility.

You set the Left Offset by first putting the printer into Printer Control State (by pressing the **[PTR]** key) and then selecting **f3=Actions**.

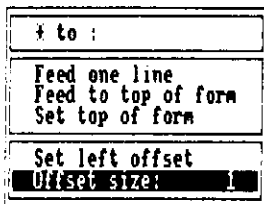

The option you need from this menu is **Offset size**. With the menu cursor on this line, you can use the left and right cursor keys to set the print position on the current line directly. Use the Paper Feed Knob for any adjustments you want to make up and down the page.

As you use the cursor keys, you will see that this both moves the print head column by column and changes the value recorded on the Offset size line of the menu. But if you hold down the **[SHIFT]** key as well as the cursor key, the print head will move an inch at a time and the Offset size will change in tens.

Alternatively you can set the Offset directly by typing in a number on the Offset size line of the menu. Whatever the character pitch you are currently working in on the screen, this number must be in terms of 10cpi characters – ie. tenths of an inch.

The Offset you set remains in force until you change it. If you move to the Offset size line of the menu and press the [] key, then the offset goes back to zero offset – printing from column 1.

Press [EXIT] when you are ready to go back to printing.

Printing part of a document

If you wish to print only a certain number of pages out of a multi-page document, you must first finish editing and return to the main Disc management menu (you cannot use the Save and Print option that is available during editing).

Print document	
Name:	DOCUMENT.000
Group:	LETTERS
Drive:	M
Print all pages	
✓ Print some pages	

When you have finished editing, select Print document by pressing P. At the bottom of the menu that appears, you will see the option Print some pages. Move the cursor down to this option (notice that the tick moves down with the cursor) and press [ENTER].

Print some pages	
Name:	DOCUMENT.000
First page	1
From page	2
To page	4
Last page	5

You will then receive another menu which indicates the first and last page numbers in the document, and lets you select the range of pages to be printed. Use the cursor to move to the page you wish to specify, then type in the required page number. LocoScript will make sure that you do not choose an invalid range of page numbers. When you are satisfied with your page selection, press [ENTER] and the pages will be printed.

If printing the document is interrupted by pressing the [PTR] key, for example because the paper becomes jammed, the Reprint menu (called up by pressing [fs]) gives you a choice of where to reprint from, including from the beginning. If you originally asked for just a section of the document to be printed, then this means reprinting from the first page of that section.

Eliminating keystrokes

LocoScript has a menu to assist you in setting each parameter needed to arrange your document the way you want it. These menus are intended to be particularly helpful when you are unfamiliar with how LocoScript generates the various word processing features.

LocoScript also gives you more direct ways of putting the relevant codes into the document to use when you are accustomed to word processing with LocoScript. These save you much of the time that is inevitably taken in going through a series of menus and submenus.

However, the menus are always there to help if you need to use them.

To understand how these shortcuts operate, it would be easiest if you have one of the sample documents up on the screen and the display in the Show Codes state. Use the Show menu for this.

Using the Set and Clear menus

The first shortcut uses the so-called Set and Clear menus, which you bring up on the screen by pressing the [.] and [] keys respectively.

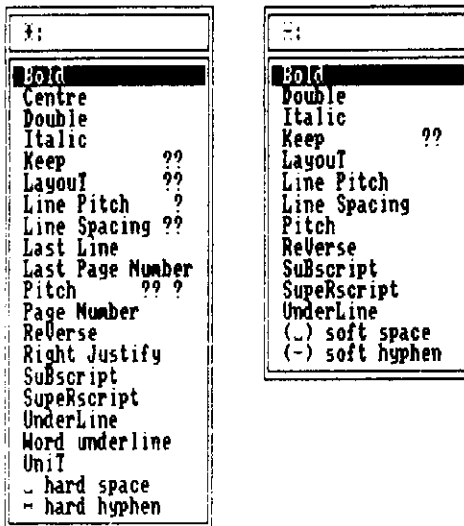

If you just press either of these keys, there will be a pause before the menu appears, but if you press the key and then press the [###] key, the menu will come up immediately.

The Set and Clear menus cover every word processing parameter that you either specifically set or specifically clear as you work through your document.

Once you are familiar with the names for the various word processing actions, you will probably find it much easier to use these menus for frequently used effects such as Bold, Double-strike and Italic characters; Centred or Right Justified text; or changes of Line Spacing or Character Pitch.

Layout is also an option of both the Set and Clear menus. Use the Set menu to change to using one of the numbered layouts, remembering to press [ENTER] after typing the layout's number. Use the Clear menu to return to using the Base Layout. Inserting a layout using one of these menus doesn't give you the extra carriage return. You can similarly use the Clear menu to return to using the Line Pitch, Line Spacing and Character Pitch specified in the Base Layout.

The Set and Clear menus work very much like all the other menus. You use the cursor keys to put the menu cursor over the feature of interest. You then have the option of typing in a parameter and/or pressing either the [.] key or [ENTER] to make your selection.

The difference is that while you can often set several features at once through a 'functional' menu, pressing either of these keys immediately plants the relevant code in the document and takes you out of the menu. If you want to put in another code at the same place in the document, you have to press [+] or [-] all over again.

Using abbreviations

The real shortcut is that you don't actually have to move the cursor at all.

As you may well have noticed, all the messages in the menus and the corresponding codes that get planted in the text have certain letters in capitals and the rest in lower case. These capital letters are important.

The moment you enter **any** of the menus – not just the Set and Clear ones – you can quickly move the cursor to the line you require by typing in any abbreviated form of its name **provided this includes the letters shown in capitals**. You can, of course, type in either upper case or lower case.

To see this work, put up the Set menu by pressing the [+] key.

Now suppose you would like to set Right Justification here. You could instantly move the cursor down to this line by now typing just RJ or rj or rightj or rtj or any other suitable abbreviation containing both **R** and **J**. Then just press [.] or [ENTER] as before.

Try this out for yourself. Notice that the Set and Clear menus get shorter as you type your abbreviation: LocoScript cuts out any option that is no longer valid.

Doing without menus

If you prefer, you don't have to use the menus at all.

Suppose you want to right justify a line; each line of your address would be a suitable example. All you need to type is |.] followed by RJ (or whatever your favourite abbreviation for right justification is): you don't even have to press a final [ENTER]. LocoScript only needs you to press [ENTER] if the menu has appeared on the screen, as it will do if you pause for a while between keystrokes.

As you type this in, LocoScript compares the letters you type with entries in the Set and Clear menus and so homes in on the word processing code you require. As soon as it has identified the code, it inserts this in your document.

If you hit a key by mistake while typing in the code's name or abbreviation, LocoScript will spot this if it cannot find any entry that matches the letters you have typed. The PCW8256 will bleep and throw away the wrong character — just carry on from there.

But if there is an entry that matches what you have typed, LocoScript won't spot your mistake. In this case, what to do depends on whether what you typed resulted in LocoScript inserting a code. If a code is inserted, press [←DEL] to erase the code inserted in error and start inserting the code again. If no code has been inserted, press [←DEL] to erase the last character you typed and carry on from there.

You can do this with any of the codes included in the Set and Clear menus. The only differences in operation are that you press the hyphen key for soft and hard hyphens, the space bar for soft and hard spaces, and that you need to press [ENTER] after typing a number as part of the code.

If you ever get confused, press the [###] key. This will put the relevant menu up on the screen and show you more clearly what you need to do to get the right effect.

Setting up a group template

A major feature of LocoScript is the way like documents are grouped together, not just on the Disc Manager screen but also in terms of having a similar layout and maybe the same initial text. The common layout and the common text are regarded as the template for the group and they are held in a special file called `TEMPLATE.STD`.

We advise you to use this grouping facility of LocoScript wisely. Take care over selecting which group to put a document in and standardise on a few standard layouts for all the documents in one group. Make these layouts part of your `TEMPLATE.STD`. This will save you from having to set up layouts afresh for each new document.

`TEMPLATE.STD` is in fact just like a document. It has exactly the same structure and can be created and edited in the same way. You can also move templates, copy them and erase them like any other documents.

The only thing that is special about it is that when you create a new document, what LocoScript actually does is to make a copy of this document and then lets you edit this copy.

A new template

If a group has no `TEMPLATE.STD` file, you can create one from the Disc Manager screen by pressing **C** – just as you would to create a new document.

LocoScript then looks to see if you have another `TEMPLATE.STD` available. The way it searches for a template to use instead is best explained by example.

Suppose the group you are working on is the fourth group on the disc in Drive A. LocoScript first looks to see if you have a `TEMPLATE.STD` in the fourth group on Drive M. If that fails, it will next examine the first group on Drive A, followed (if necessary) by the first group on Drive M.

If all else fails, LocoScript will use the template built into the software: this gives you a simple layout suitable for A4 paper, with the text printed in the standard character pitch of 12 characters per inch.

You can take advantage of the way LocoScript searches for a template to put the eight `TEMPLATE.STD` files you want to use on your Start of Day disc, rather than on Data discs. The PCW8256 will automatically copy these files into Drive M as part of loading the LocoScript software.

Editing TEMPLATE.STD

Note the editing actions described here are not limited to editing TEMPLATE.STD – they apply equally well to editing any individual document.

The first thing to edit is the Base Layout within this document, if this does not meet your requirements.

You edit the Base Layout by editing the document's File Header. The editing menu that includes this option is the Modes menu – so start by pressing [*f7*].

The line to select from this is Edit Header, which puts up a new screen (the one for editing the Header and Footer zone text) and a new set of function key actions.

```
f1=Now f2=Analysis f3=Title f4=Pages f5=Pages f7=Options f8=Blocks EX11
-----
-----end of header 1 : used for all pages-----
-----end of footer 1 : used for all pages-----
-----end of header 2 : used for no pages at all-----
-----end of footer 2 : used for no pages at all-----
```

Select *f7=Options* . This puts up a further set of function key actions.

```
f1=Layout f3=Characters f5=Tab count f6=Breaks f7=Page size f8=Paqination EX11
-----
```

To change the Base Layout from here, you need *f1=Layout* . Selecting this puts you into the Layout Editor. You now have all the facilities to change the parameters of the Base Layout that you had when you edited other layouts. There is no difference in their operation here. Turn back to Stage 4 if you are unsure how to change these parameters.

Once you have the Base Layout set up to your satisfaction, we suggest you spend some time setting up a few 'standard' layouts for you to use. Either work from your Base Layout, creating some new layouts, or examine the layouts you already have set up (if any), sort out the ones you really want to use and get these just right.

Again, turn back to Stage 4 if you are unsure how to do this.

You can also set up (and change) the text part of a TEMPLATE.STD – exactly like you change the text in any document. For instance, one of your first actions might be to replace the phrase 'Your address' in the template for the LETTERS group with your actual address. You could, at the same time, ensure that your address is right justified and that 'Addressee' and 'Dear' are in exactly the right place for your window envelopes.

You can also make a copy of this template as the `TEMPLATE.STD` for another group but this time replace your address by blank lines. This would give you a suitable template for use with headed notepaper.

When you have finished, it would be a good idea to print out your `TEMPLATE.STD` files and keep the print-outs for reference. If you would like to keep a record of the layout information as well, you can do this by getting the printer to produce a dot by dot image of the screen while it has the layout on it. All you need to do is press `[EXTRA]` and `[PTR]` simultaneously and then wait while the image is printed.

Other changes to File Header

The other changes you can make to the File Header are accessible both directly from the Modes menu and additionally through the Options menu.

Selecting Edit Header from the Modes menu gives you the chance to edit the Header and Footer zone text for your documents. You could, for example, set up a group that would have 'CONFIDENTIAL' printed at the top of each page.

The other possibilities come from selecting `f7=Options` from within Header and Footer text editing.

Three of these – Breaks, Page size and Pagination – we covered in discussing ways of enhancing how your text is set out on the page (see Stage 6). You might use the Page size option to ensure that a particular group of documents would be laid out properly for some special size of paper.

The others set up your documents in a more technical way, so you are likely to use them rarely.

Characters:
Zero is 0 <input checked="" type="checkbox"/>
Zero is 0
Decimal is . <input checked="" type="checkbox"/>
Decimal is ,

Characters gives you two choices. One is the option of changing between using zeroes with and without slashes through them. The other is between using a decimal point (.) and a comma (,) as the character used by LocoScript to align columns of numbers at a decimal tab. You might need this if you have to produce a report for use abroad.

Maxima:
5 layouts
10 tabs each

Tab count allows you to reset the maximum number of layouts allowed in the document and the maximum number of tab stops allowed in each layout.

The absolute maximum for either of these is 99 but you will rarely need anything like this number. Choose a number that reflects what you need: asking for more than that will waste disc space.

Summaries of your documents

As a further step in refining a document, you might like to set up a short piece of text, called an Identity, that you can use later to quickly discover what text the document holds.

You can look at a document's identity without editing the document. One of the actions you can carry out directly from the Disc Manager screen is to 'Inspect' the identity of a document you pick out. You just press [\square f_2] and identify the document you want to know about the usual way. Whatever text has been set up will be displayed.

Setting up this text involves calling up the Modes menu from within document editing and then selecting `Edit Identify text`. A special area is then marked out on the screen which gives you precisely three lines of 30 characters in which to set up a summary of the whole document.

Set up each line in turn. If you make any mistakes move the cursor back over what you have typed and make whatever corrections are required. You do not have to delete characters back to where you made the mistake and type in the remaining text from there. You can also use the [\square] key to clear from the cursor position to the end of the line. As you complete each line, move down to the next.

LocoScript summarised

This chapter provides an easy reference guide to the facilities of Locomotive Software's LocoScript word processing software, intended to be used when you are familiar with using LocoScript but just wish to check some aspect of the system.

In practice, you will rarely need to refer to this chapter as the menus give you all the information you need.

How LocoScript views your documents

LocoScript records any document as a long sequence of characters – some of them spelling words; others of them codes that tell it how to process the following characters, rather than specifying their exact positions.

In this it is unlike many word processing systems which view documents as if they were already printed on a page.

Codes can be inserted anywhere within the document and they can be deleted just as if they were simple characters. Some of them have a predefined length of effect: others are paired – one to turn the effect on, the other to turn the effect off.

The information LocoScript needs to interpret these codes is stored separately. Some of this information is permanently part of the LocoScript software; the rest – Layouts and File Headers – you can set up as you wish. All you need to ensure is that you have inserted the codes you want.

This view of a document gives LocoScript a lot of flexibility. You do not need to edit a document line by line or paragraph by paragraph, just because you decide to change the position of the left hand margin. Similarly, it is easy to undo any change of layout that you later regret.

Key features of LocoScript

The things about LocoScript to always keep in mind are:

- LocoScript uses Current information as the starting point for any change. The idea of this is to minimise the amount of work you need to do to carry out a minor change. Thus the layout you are offered as a starting point when you create a new layout, is the one you have just been using.

It also views the document you have just been working on as the Current document until you direct it to another file. This means that if you want, for example, to copy a document immediately after you have edited it, you don't have to tell LocoScript the details of the file all over again.

Similarly on the Disc Manager screen, directing the file cursor to the document you want is enough to tell LocoScript that this is the file you are interested in. You don't have to type a single character of its name.

This notion of what is current can be used to great effect.

- The top line of the Document Editing screen displays what codes are active at the current cursor position. The line of function key assignments tells you only what actions you can access from your current state by pressing these.
- Some keys have specific roles – for example, the textual movement keys [CHAR], [WORD], [LINE], [EOL], [PARA], [PAGE] and [DOC].

[ENTER] is always used to confirm an action; [CAN] to tell LocoScript that you want to abandon the current action; and [EXIT] to leave the current state – whether that is editing a document or controlling the printer.

The [I] key is always used to set some parameter or to insert the code that turns on some word processing action. The [:] key is always used to clear a previous setting or turn off the effect of a previous code.

[CUT] followed by a second [CUT] deletes the text between the places the two cuts were made.

[COPY] followed by a second [COPY] and a digit (or a letter) copies the text between into the Block (or Phrase) identified by the number (or letter), leaving the original text intact. If the second [COPY] is replaced by [CUT], the text is copied into the Block but deleted from the document.

[PASTE] followed by a digit or a letter pastes the contents of a Block or a Phrase into the document at that point.

[UNIT] moves the cursor to a marker inserted in the text. It works like the other Textual Movement Keys. Pressing the [UNIT] key will move you to the next marker in the text; holding down the [ALT] key at the same time as pressing [UNIT] will move you to the previous marker. The markers are inserted through the UniT option of the Set menu.

[FIND] asks for a piece of text to match against the document and searches forward to find this.

[EXCH] asks for a piece of text to search for in the document and for a second to replace this text by. If the next key pressed is [PARA], [PAGE] or [DOC], LocoScript will make the exchange within the indicated parts of the document. If the next key pressed is [ENTER] LocoScript will prompt for confirmation at each possible exchange. Press [+] to exchange; [] to go on to the next case; and [CAN] to exit.

- The cursor keys always move the cursor that is relevant to what you are doing, whether this is typing in additions to a document or moving between options in a menu or moving from parameter to parameter as you edit the details of a layout.
- LocoScript accepts a wide range of different layouts and print styles in the same document. This will often mean that the right hand edge of the text on the screen will be distorted, particularly as you change from one character pitch (size) to another, because only one style of characters can be displayed on the screen. But these lines correspond exactly with the lines when the document is printed, both in terms of where each line breaks and where each page breaks.
- LocoScript constantly corrects any mis-setting of the text following major editing all the way up to the point in the text you are currently working on.
- LocoScript will also provide you with as much or as little information about the codes that are setting out your document as you want. The choice is yours whether to display the mnemonics of the various codes, the changes of margin and tab settings associated with changes of document layout or even the difference between the spaces in the document you have typed and those that have resulted from the way the document is being laid out.
- When LocoScript detects a problem, for example in storing or reading a document for you, it displays a message in a box on the screen advising you of the problem and telling you what possible actions you can take. In particular, you will be warned if an action will result in the loss of the editing you have just done. The box incorporates a cursor, rather like a menu cursor. Make your selection of which action to take in exactly the same way as you select options from a menu. This action takes precedence over any other actions you might be expecting LocoScript to carry out.
- For all its sophisticated features, the PCW8256 running LocoScript has Shift, Shift Lock and Tab keys that work in the same way as those on traditional typewriters. If you wish, it can also act as an electronic typewriter, printing out prepared material line by line.

Operating the menus

Menus form an important part of LocoScript because they are the medium through which most of the codes are inserted, particularly when you are new to using LocoScript.

You call up most of the menus by pressing the key suggested in the information lines at the top of the screen.

You then move the cursor to the right option in the menu, either by using the Up and Down cursor keys or alternatively by typing an abbreviated form of the name of the option. This abbreviation must include the letters shown in capitals but can otherwise be as much of the full name as you choose.

If the option is something you might want to set or to clear, then press the [] key to set it – this puts a / next to the item on the menu. If you want to clear it (ie. there is already a / next to it), press the [] key. When you are happy with all the settings, press the [ENTER] key: this puts the right code into your document and takes you out of the menu.

If the option is one you select rather than set, then press either [] or [ENTER]. These keystrokes

Either
put the right code into your document and take you out of the menu

or
put up a submenu from which you make a further selection

or
put up a special screen for you to work on.

Pressing [ENTER] from either the submenu or the special screen will return you to your document.

The above should give you a good picture of the general principles involved. They are necessarily very general. If you are in any doubt as to what keys to press, refer to the sections below where the word processing actions and the menus that access them are described in detail.

If, at any time, you want to leave a menu without setting the codes, press [CAN]

LocoScript shortcuts

The Set and Clear menus

The Set and Clear menus provide an alternative to 'functional' menus. They offer a quick way of setting and clearing word processing features such as underlining and justification, but you need to remember which codes do what in more detail than you do when you use their functional counterparts.

The menus are accessed by pressing **[+]** for the Set menu and **[-]** for the Clear menu. Press the **[###]** key if you want to see the full menu. This, however, will appear anyway after a short while.

Each time you access either menu, you may only make one selection which you do by moving the cursor to the right line and pressing either **[+]** or **[ENTER]**. Alternatively you can type in an abbreviation of the title of the code you want, whereupon the menu shrinks – leaving you with just the code you requested. This abbreviation must contain the letters shown as capitals.

Note:

that a hard space is inserted by pressing the space bar from the Set menu and a hard hyphen by pressing the hyphen key

that a soft space is inserted by pressing the space bar from the Clear menu and a soft hyphen by pressing the hyphen key

Avoiding the menus

Where you want to insert a code in the document that either sets or clears a word processing feature, you can do this by typing either **[+]** or **[-]** followed by an appropriate abbreviation for the code you require. This abbreviation must include any capital letters in the name of the feature, as displayed in either the Set or the Clear menu.

This is, in fact, the same as using abbreviations within the Set and Clear menus – except you don't wait for the menu to pop up and you don't press **[ENTER]** to finally insert the code.

What you type is shown in a patch on the screen. If you make a mistake, press **[←DEL]** and correct from there. Note, LocoScript may have already planted a code in your document – so make your corrections according to the effect what you type has on what is displayed in the patch.

You can always erase unwanted codes from your document by using the **[←DEL]** key.

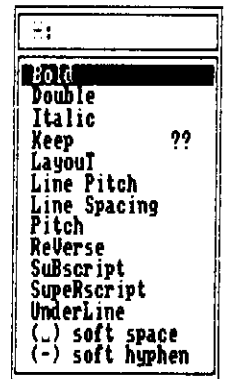
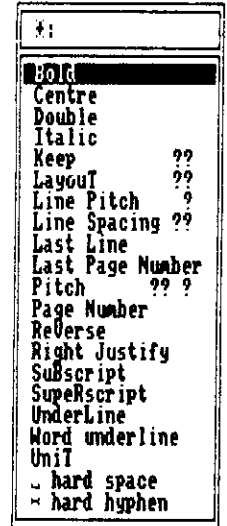

Summary of the word processing menus

The Show menu

All the options on this menu can be either set (with a / beside them) or cleared. The current state of these settings is stored with each document.

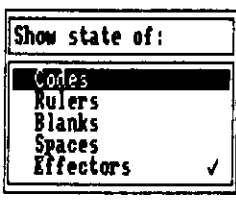

The description below describes the action when the option is set.

Codes

All the codes within the document that control word processing features are displayed on the screen as part of the document.

Rulers

Any rulers that have been set within the document are displayed above the first line to which they apply.

Blanks

All places within the document where nothing has been typed are shown as dots.

Spaces

All spaces (as distinct from blanks) within the document are shown as bullets.

Effectors

All carriage returns, tabs and 'End page here' symbols are displayed as part of the document, rather than hidden.

The Layout menu

Selections from this menu are made using the [+] key.

Insert Layout

brand New layout

The screen changes to allow you to set up a new layout, taking the layout you have just been using as your starting point. The keys you need to press to change the various parameters of the layout are indicated in the information lines at the top of the screen. Press [EXIT] when you have finished setting up the new layout. LocoScript automatically gives this layout a new number which is displayed in the information lines while you are using it. It also inserts a carriage return so that the ruler part of the layout can be effective immediately.

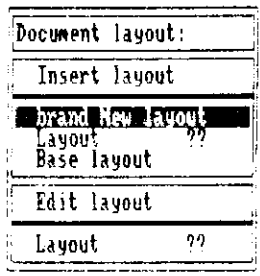

You will not be offered this option when all your layouts are in use. If you need more layouts, you must go into Header Editing (through f7=Modes).

Layout ??

Type in the number of the layout you want to use and then press [ENTER]. The layout you requested will be used from the beginning of the next line and its number displayed in the information lines.

Base layout

Makes the current layout the one specified as your base layout. It will become effective at the beginning of the next line.

Edit Layout

current layout

The screen changes to allow you to alter the layout line. The keys you need to press to change the various parameters are indicated in the information lines at the top of the screen. Press [ENTER] when you have finished setting it up. The new version of the layout becomes effective at the beginning of the next line.

You will not be offered this option if the current layout is the Base Layout. To edit the Base Layout, you must go into Header Editing.

layout ??

Type in the number of the layout you want to change and then press [+] or [ENTER]. The screen changes to allow you to alter the layout you have just specified. The keys you need to press to change the various parameters are indicated in the information lines at the top of the screen. Press [ENTER] when you have finished setting it up. These changes will only affect those parts of the document that use this layout.

The Emphasis menu

The items in this menu can either be set or cleared by pressing the [.] and [-] keys. [ENTER] is pressed when you have the combination you require.

The description here describes the state when the parameter is set. Only setting the Underline option calls up a further submenu.

Underline

Full underline Both words and the spaces between words are underlined. The underlining appears both on the screen and when the document is printed.

Word underline Words are underlined but spaces are not. The underlining appears both on the screen and when the document is printed.

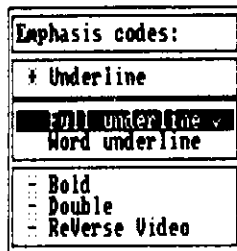

Bold

Subsequent characters are emboldened. This only shows when the document is printed. Bold is not shown on the screen.

Double

The printer is put into its Double-strike mode for printing subsequent characters. The effect is not shown on the screen.

ReVerse Video

Subsequent characters on the screen are shown in reverse video. The effect is not shown when the document is printed.

The Style menu

The items within this menu can be set or cleared using the and keys. The description here generally gives just the result of setting the option.

Setting either Half height or Pitch calls up the associated submenus.

Italic

Subsequent characters will be printed as italic (ie. slanted) characters. The effect is not shown on the screen.

Half height

Superscript Subsequent characters are printed half height and raised. The effect is not shown on the screen.

Subscript Subsequent characters are printed half height and lowered. The effect is not shown on the screen.

Pitch

Selecting a new pitch setting cancels any earlier pitch setting. Similarly, setting either Normal width or Double width cancels any earlier width setting.

Clearing pitch sets the pitch to the base pitch for your document.

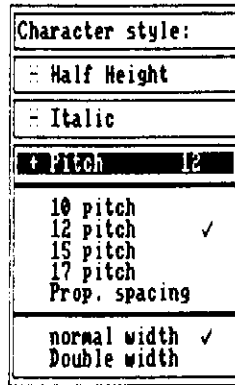

The Pages menu

Options are selected from this menu by pressing [F]

Last Line of page

Marks the line as the last line of the page. The next line of the document will always appear at the top of the next page. This overrides any Keep instructions that may apply.

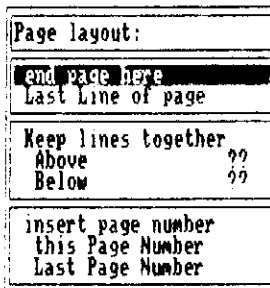

end page here

Marks the current position as the place where the line will break. The next character will always appear at the top of the next page. This overrides any Keep instructions that may apply.

Keep lines together

Above ?? Allows you to set the number of lines above the current position that should not be divided by a page break. The current line is included.

Below ?? Allows you to set the number of lines below the current position that should not be divided by a page break. The current line is included.

insert page number

this Page Number Inserts the code that precedes the string of '<'s, '>'s or '='s that mark where you want the number of the current page to be inserted.

Last Page Number Inserts the code that precedes the string of '<'s, '>'s or '='s that mark where you want the number of the last page of the document to be inserted.

The Modes menu

Allows disc management from within a document and editing of the document header. Selections are made by pressing [F]

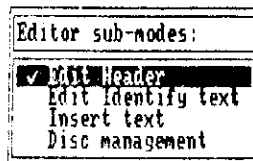

Disc management

Allows general disc housekeeping, for example, deleting a file if the disc is full.

Edit Identify text

Puts up an editing screen to allow you to edit the document's summary. The text can be no more than 90 characters long. Press [ENTER] when you have finished editing this text.

Edit header

First puts up the screen in which you edit the Header and Footer text. Most of the function key actions are those of document editing.

Selecting Options gives you a second set of function key actions as follows:

f1 Layout

Puts you into Layout Editing so that you can edit the base layout

f3=Characters sets

zero character is with or without a slash

decimal tabs aligned on full stops or commas

f5=Tab count sets

the maximum number of layouts you wish to set

the maximum number of tabs that can be set within a layout.

The highest values either of these can take is 99, but the bigger this setting the bigger your documents will become. Ten of each should meet most requirements.

f6=Breaks sets

widows and orphans (one line of a paragraph on a different page) prevented or allowed
breaking paragraphs between two pages prevented or allowed

f7=Page size sets

the page length, the depth of the Header Zone, the position of the first line of header text within the Header Zone, the depth of the Footer Zone and the position of the first line of footer text within the Footer Zone.

All parameters are given as a number of whole lines. The distances for the Header Zone are measured from the top of the page: those for the Footer Zone are measured from the bottom of the page.

Page size:	
Page length	70
Header zone position	9
∴ page body	54
Footer zone position	7

The number of lines in the page body resulting from your choice of other dimensions is displayed in the centre of the menu. If the net effect of your choices is impossible to achieve, then the message inconsistent will appear immediately below the page body. You will not be allowed to [ENTER] this choice.

f8-Pagination

First page number sets the number of the first page. This cannot be greater than 9999. All other page numbers are calculated from this value.

All pages same uses the same Header and Footer text on all pages.

First page differs uses different Header and Footer text on the first page to the rest of the document.

Last page differs uses different Header and Footer text on the last page to the rest of the document.

Odd/even pages differ uses one set of Header and Footer text for odd-numbered pages and another for even-numbered pages.

First page sets whether the Header text and/or the Footer text are printed on the first page.

Last page sets whether the Header text and/or the Footer text are printed on the last page.

Pagination:	
First page number	
All pages same	<input checked="" type="checkbox"/>
First page differs	<input type="checkbox"/>
Last page differs	<input type="checkbox"/>
Odd/even pages differ	<input type="checkbox"/>
First page	
Header enabled	<input checked="" type="checkbox"/>
Footer enabled	<input checked="" type="checkbox"/>
Last page	
Header enabled	<input checked="" type="checkbox"/>
Footer enabled	<input checked="" type="checkbox"/>

Insert text

Puts up the Disc Manager screen so that you can pick out the document you want to insert in the current text.

The Blocks menu

Block

Lists all the blocks that currently have text stored in them.

Save block ?

Allows you to save a particular block to disc. Pressing **[ENTER]** causes the Disc Manager screen to be displayed to help you choose what name to give this new document and where it should be stored.

Text storage:	
Block	
Save block ?	
Phrase	ABCD
K M P RS	Z
Save all phrases	

Phrase

Lists all the Phrases that currently have text stored in them.

Save all phrases

Allows you to save the current set of phrases as your new PHRASES.STD file.

Appendix I

Troubleshooting

On pressing the Power button, the PCW8256 fails to display a bright green screen

- Turn off the power by pressing the Power button a second time.
- Disconnect the PCW8256 from the mains supply.
Plug a table lamp that you know to be working into the mains supply to check your mains outlet.
- Check that the plug on the PCW8256 has been correctly wired (see Chapter 1)
- Disconnect and then reconnect the keyboard and the printer to the PCW8256 Monitor unit.
- If an RS232C/Centronics Interface is fitted, disconnect this.
- Plug the PCW8256 back into the mains supply, remembering to switch on any mains switches.
- Finally, press the Power button again.

If the screen still does not come up bright green, consult your dealer.

You are unable to insert your disc in the drive

- Check that there is not already a disc in the drive. If there is, you should be able to see its label.

Any disc already in the drive will be released when you press the Eject button on the drive.

Check that you are trying to insert the disc the right way round (see Section 3.1.2).

On inserting a Start of Day disc (see Chapter 3), the screen does not show the appropriate welcome message.

If the familiar pattern of lines appears on the screen but the wrong message appears, you have inserted the wrong disc.

Release this disc, insert the right disc with the side you want to use to the left, then hold down [SHIFT] and [EXTRA] and press [EXIT]. The correct software should now be read into the computer.

- If the screen stays bright green or flashes and after a few moments, the PCW8256 beeps a few times, either you have not inserted a Start of Day disc or your disc is damaged. Release the disc and check that it is the one you wanted to use.

If necessary, try loading the software from your master disc. If this works, make a new Start of Day disc (see Chapter 3); if it doesn't, consult your dealer.

On attempting to move the cursor or to access one of the special functions or to type something in, nothing happens

- Your keyboard might not be connected properly. Unplug the keyboard from the Monitor unit and then plug it in again (see Chapter 1).

If it still fails to respond, either your keyboard or your Monitor unit may be faulty: consult your dealer.

On attempting to print a document, the printer does not respond

- Check that the bail bar is back on the platten and that there is paper in the printer.
- Press the [PTR] key to put the PCW8256 into Printer Control State (if the computer hasn't already done this for you) and check that the printer is On-line. In particular, check that it is not Waiting for Paper (see Stage 8).
- Release the disc in the drive, switch the PCW8256 off and then check that the printer is properly connected (see Chapter 1).

Paper does not autoload

- You have inserted the paper too far by hand. You should simply rest it in the guide.

On attempting to print a document, the printer appears to print but nothing is printed

- Check that there is a ribbon cassette in the printer.

While printing a document, the paper becomes jammed in the printer

- Press the [PTR] key. This halts printing.
- Either pull the bail bar forward or turn the Paper Loading Knob a quarter of a turn towards you.
- Free the paper jammed in the printer and reload with fresh paper. Select the Document/Reprint menu if you want to print the page again (see Stage 8).

Document printed in wrong position on the page

- Check that the Left Offset is the value you expected. You can check this by pressing the [PTR] key and then selecting the Actions menu (see Stage 8).

Check that the paper the printer is set up for is the same as that LocoScript paginated the document for.

You can check the printer settings by pressing the [PTR] key and then selecting the Options menu (see Stage 8).

You can check the document settings by editing the document. The length of the page is displayed in the information lines.

The PCW8256 beeps as you edit a document

- You have called up a menu (eg. the Set or the Clear menu) and not pressed [ENTER] or [CAN] before carrying on typing your document. Check your current position, press [ENTER] or [CAN] and then carry on with your edit.
- You have put the PCW8256 into Printer Control State by pressing the [PTR] key, pulling the bail bar forward or loading paper into the printer. To leave Printer Control State press [EXIT].

Appendix II

The printer: Loading and maintenance

II.1 Paper for the printer

The printer will handle ordinary bond paper provided it is not too flimsy (less than 50gsm) or too stiff. It will also handle copies (on 40gsm paper) at the same time as the originals are being printed.

The printer is set up for A4 single sheet stationery or 11inch continuous stationery, but it can handle other sizes as well. The processes involved in setting up both your documents and the printer for your chosen size of paper are described in Stages 5 and 8 of the Guide to LocoScript.

II.2 Autoloading the printer (single sheet paper)

The printer is set up so that paper resting in the paper guide can be automatically fed into the printer and left so that printing will begin in the correct position.

The actions you have to take are very simple.

First place the paper you wish to use centrally in the paper guide so that its top edge rests against the back of the printer platen (the rubber roller).

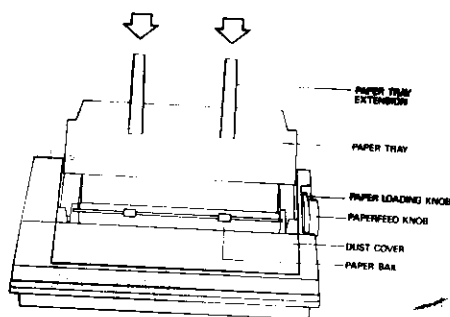

Next turn the outer Paper Loading Knob one quarter of a turn towards you. The bail bar also moves forward.

The printer itself now feeds the paper in.

Turn the outer knob back to its original position. This puts the bail bar back too.

If the paper needs any further adjustment, you can do this now.

A single sheet of paper will now be in the right position for you to start printing.

Continuous stationery

If you plan to use continuous stationery, you should have the additional tractor feed mechanism fixed to the top of the printer. Before fitting the tractor mechanism, remove the paper tray by hinging it to a vertical position and then lifting it off.

Next, with the white cog-wheel (underneath the tractor mechanism) to your left, lower the two small outer hooks at the front of the mechanism into the two small holes (slightly forward of the platen) on top of the printer. Finally, clip the back of the mechanism down into position.

Now feed in the paper to the printer from behind the back of the tractor mechanism as if it were single sheet paper. Then, with the bail bar back in position against the paper, take in a further few inches of paper for putting into the tractor mechanism. Open the tractor covers and place the paper over the tractor cogs (you may need to slide the tractors sideways to align the cogs with the paper's holes). Finally, close the tractor covers.

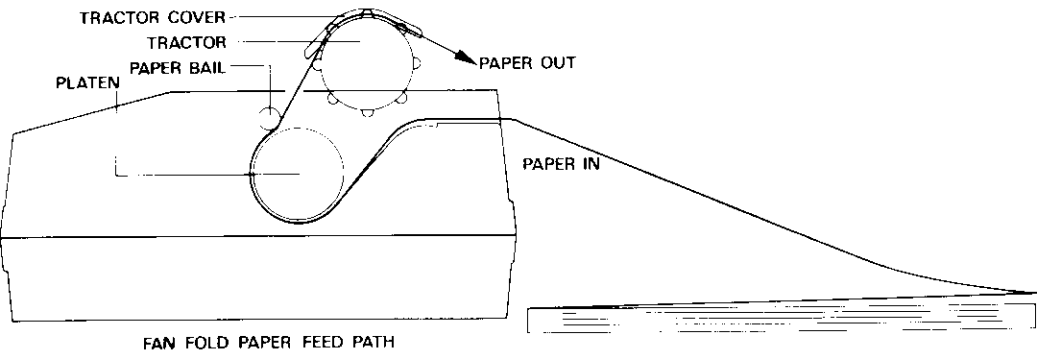

When the paper is loaded in the tractor mechanism, turn the Paper Feed Knob until the print position is approximately $\frac{1}{6}$ inch below the next line of perforations. This is its Top of Form position.

You should now be ready to start printing (see Stage 8).

Removing the tractor mechanism

The tractor mechanism should be removed when you go back to using single sheet stationery. To remove the mechanism, simply pull it forward from the back and lift it off the printer.

To replace the paper tray, simply hold it vertically over the hinge pegs, then lower it into position.

II.3 Changing the ribbon

The ribbon is contained in a cassette. When you need to change the ribbon, simply exchange the old cassette for a new one.

When you buy a printer ribbon, you should ask for an Amstrad Printer Ribbon (PR-1).

Removal

First lift the dust cover gently up. It is hinged, but you need to release it from the hinges before you can remove the ribbon cassette.

Hold the 'fin' on the top of the cassette and lift the old cassette out.

Putting a new cassette in

Hold the new cassette with its 'fin' upperwards and the ribbon away from you.

Turn the ribbon feed knob to the left of the fin in the direction of the arrow to remove the slack in the ribbon.

Then slot the cassette into position, taking care that the ribbon itself passes between the print head and the ribbon guide. Be careful not to twist the ribbon.

Do not touch the print head: if you have just been printing out a document, the head could be very hot.

Press down gently on both sides of the cassette to ensure it is properly located.

Check that the ribbon is properly positioned in front of the print head and remove any slack in the ribbon by gently turning the ribbon feed knob.

Do not try to print without the ribbon cassette properly installed.

II.4 Adjusting the print head

The print head is moved with the aid of the head adjustment lever on the inner right-hand side of the printer.

This selects one of five positions. Use the lower settings for thinner paper, the higher ones for multiple thicknesses (for example, a top copy plus two flimsies). Position 2 should be right for a single thickness of ordinary paper.

Incorrect positioning of the print head can result in light or smeared print.

II.5 General hints

Do not touch the print head immediately after printing because it may be very hot.

The printer will work best if the room it is kept in is neither damp nor dusty. It is also better not to use it in direct sunlight.

Clean the printer of paper dust once in a while. You can use a blower device or the suction extension of an ordinary vacuum cleaner to do this.

Appendix III

Using LocoScript files in other programs

III.1 Making an ASCII file

LocoScript documents contain a number of special codes that specify how the text appears on the screen and how it is to be printed. These codes are special to LocoScript, and can't be used by other programs.

When you want to use a LocoScript document with another program, you have first to prepare a version of the document that has been cleared of all these codes. The procedure for doing this is called 'Making an ASCII file'.

There are two types of file you can make. One is a 'Simple text file' which retains none of the detailed layout information in the document (though it does retain any tabs and carriage returns you put in). It is a very standard text file.

The other type is a 'Page image file' in which spaces have been inserted into the file to preserve the layout the document had on the screen. All the line breaks are kept, with hyphens where words are broken, and ASCII form feed characters are inserted at the bottom of each page. Such a file can be sent over a communications link or printed out on a daisy-wheel printer.

The Page image file also has the correct pagination (header and footer) text at the top and bottom of each page, and the correct page numbers are inserted in place of the 'this page' and 'last page' codes. The Simple text version does not contain any pagination text and no page numbers are inserted. Instead the symbols = < > are kept to mark where page numbers are to be inserted.

LocoScript has a number of special characters, for example ¶, π, ñ, and £. These characters do NOT have an 'Official' ASCII representation, but have been allocated codes (many of which will show correctly on the screen when using the CP/M supplied with your PCW8256) which have been listed in Appendix I.4. If your document contains any of these special characters it may be necessary for you to use a small conversion program before your document will be fully understood by the printer or the program receiving the converted file. We regret that Amstrad are unable to discuss any special requirements that you may have regarding such conversions.



You can make an ASCII version of one of your files from the Disc Manager screen. With the file cursor positioned over the file you want to use, press and select Make ASCII file from the menu that appears. The top two lines of the screen then display a message asking you to pick out the group (using the cursor keys) where you want the ASCII to be stored. You can either store it on a disc or temporarily in Drive M. When you have made your selection, press .

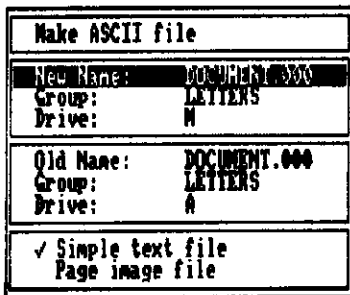

A menu then appears giving you details of the LocoScript file and the new ASCII file. You can change any of these details. The bottom section of the menu lets you select which type of ASCII file you want (Simple text file is automatically selected for you). Cursor down to the bottom of the menu if you wish to select Page image file.

When all the details in the menu are correct, press . The ASCII version of the file is then created and stored.

Before you can use the ASCII version, you will need to transfer it to an appropriate disc. Your LocoScript discs are best used only for LocoScript files.

If you stored the ASCII file in Drive M, then you can change the disc in Drive A (remember to press after you have put the destination disc in Drive A) and then use the LocoScript function to copy the file to this disc.

(If you stored the ASCII file on your LocoScript disc, you can transfer it to another disc using the PIP utility the next time you load CP/M. You will find that this is much easier if you store the ASCII file in the first Group of the LocoScript disc.)

III.2 File communication

To send the resulting file to an alternative printer or electronic mail service please refer to the User Instructions for the CPS8256 Serial/Parallel interface, summarised below:

MAIL232	Electronic mail program from side 1 of the system discs.
DEVICE LST:=CEN	Menu <input type="button" value="fs"/> includes Send-a-file function.
DEVICE LST:=SIO	Says the printer you want to use is attached to the CPS8256 Parallel port.
PIP LST:=<filename>	Says the printer you want to use is attached to the CPS8256 Serial port.
	Sends the file to the printer.

Index

- A4 paper, 116
 - Accented characters, 52
 - Actions (printer menu), 117, 119
 - ALT key, 10
 - plus textual movement keys, 64
 - ASCII files, 149
 - Auto-repeating keys, 15
 - Back-up copies, 33
 - Bail bar, 115, 146
 - Base layout, 83, 135
 - editing, 126
 - Base line pitch, 98, 99
 - Base pitch, 136
 - Blank lines, 15
 - Blanks, 84, 134
 - Blocks
 - listing those in use, 112
 - maintaining, 112
 - menu, 112, 140
 - saving, 112
 - to move text about, 111
 - Blocks of text
 - cutting, 68
 - moving, 69, 70
 - Bold, 55, 136
 - Brand new layout, 134
 - Brightness thumbwheel, 7

 - CAN key, 130
 - Caps lock, 10
 - Carriage movement, 14
 - Carriage return, 15
 - Centre tab, 78
 - Centred text, 87, 137
 - Change discs, 43
 - Changing a layout, 93
 - CHAR key, 64
 - Character sets, 139
 - Characters, 129
 - changing width of, 87, 89
 - deleting, 15
 - double width, 89
 - typed on keyboard, 10
 - used as decimal point, 127
 - with accents, 52
 - Characters menu, 127
 - Clear menu, 121
 - Codes, 59, 129, 134
 - deleting, 60
 - direct entry, 121
 - display of, 130
 - mnemonics, 122
 - Columns of figures, 76
 - Comma as decimal point, 127
 - Connecting up the PCW8256, 2
 - Continuous stationery, 116
 - COPY key, 130
 - Copying discs, 33, ptIII
 - Copying documents, 38, 43, ptIII
 - Copying text, 70, 130
 - Correcting mistakes, 18
 - CP/M Plus
 - used to prepare discs, 31
 - Creating a document, 12, 42, ptIII
 - Current document, 41, 130
 - Current layout, 78, 135
 - Cursor, 15
 - file and group, 41
 - Cursor keys, 131
 - Cut and paste, 69, 70, 130
 - blocks, 111
 - phrases, 113
 - CUT key, 130
 - Cutting text, 67
 - to a particular word, 68

 - Data discs, 47, 48
 - Decimal point character, 127, 139
 - Decimal tab, 76
 - DEL keys, 15
 - Deleting characters, 15
 - Deleting codes, 60
 - Deleting text, 67
 - to a particular word, 68
 - Direct printing, 43, 115, 118
 - position, 119
-

Disc drives, 40
 Disc management, 138
 Disc manager, 39
 DISCKIT, 31, 34, ptIII
 Discs
 changing, 43
 copying, 33
 CP/M, 45
 data, 45, 47, 48
 errors, 30
 failure to insert, 141
 formatting, 30, 47
 holding LocoScript, 45
 housekeeping, 43
 how to handle, 31
 keeping documents on, 27
 loading and unloading, 31
 operations, 41
 organising your work on, 36
 preparing for use, 45
 sides of, 28
 start of day, 45, 46
 storage of, 31
 suitable for the PCW8256, 27
 system, 45, ptIII
 write protecting, 13, 29
 DOC key, 64
 Document header, 102
 Document/Reprint (printer menu), 117
 Documents
 content when created, 125
 copying, 43
 creating new, 12, 42
 current document, 41
 editing existing, 42
 erasing, 44
 exchanging text strings, 71
 group of, 36
 how instructions are stored, 59
 inserting other documents, 112
 inspecting, 43
 introduction to, 38
 keeping on disc, 27
 locating particular text, 68
 moving, 43
 moving about, 15

 moving backwards through, 64
 moving blocks of text about, 69, 70
 moving blocks of text around, 111
 moving forwards through, 64
 names of, 12, 36, 41
 organisation of, 129
 organising on disc, 36
 printing, 23, 42, 120
 recovering from Limbo, 43
 relaying, 65
 removing part of, 67
 renaming, 43
 reprinting pages of, 117
 setting identity, 128
 setting out, 73
 splitting into lines, 17
 splitting into pages, 97
 template, 125
 Dots, 84
 Double strike, 136
 Double width characters, 89, 136
 Down cursor, 15
 Draft quality printing, 115
 Drive A B and M, 40, ptIII

 Edit header, 105
 Edit identity, 138
 Edit layout, 135
 Editing
 a layout, 93
 existing documents, 42
 file header, 127
 layouts, 79, 83
 ruler line, 79
 Editing keys, 63
 Effectors, 84, 134
 Emphasis
 how it is stored, 59
 in headers and footers, 109
 in page header and footer, 107
 removing from document, 60
 shown on the screen, 58
 turning off, 58
 Emphasis menu, 55, 135
 Emphasising text, 55
 End of line key, 64

End of page line, 98
End page here code, 101, 138
Enhancing text, 55
ENTER key, 130
EOL key, 64
Equipment, 1
Erasing characters, 15
Erasing documents, 38, 44
Errors
 track and sector information, 30
Even and odd pages, 106
Exchange text, 131
Exchanging text, 71
 options, 71
EXIT key, 130
EXTRA key, 10

Failures, 141
File communication, 150
FD-2 drive, pIII
File cursor, 41
File header, 102
 editing, 127
Filenames, 41
 rules for, 37
Files, 36
 ASCII, 149
 hidden, 44
Filing documents on disc, 36
FIND key, 68
Find text, 131
Finding text, 68
 and replacing, 71
Finishing
 editing a document, 23
 using the PCW8256, 26
First page
 header and footer required, 109, 140
 number, 108, 140
Footer zone, 97, 139
 putting text into, 105
Form filling, 119
Formatting discs, 30, 47
Forwards movement, 64
Full stop as decimal point, 127
Full underlining, 55

Function keys, 130

Group cursor, 41
Group of documents, 36
Groups
 rules for names, 37
 templates, 125

Half height, 61, 136
Hard hyphens, 95, 133, 137
Hard spaces, 95, 133, 137
Header, 138
 file, 102
 options, 139
Header zone, 97, 139
 putting text into, 105
Hidden files, 44
High quality printing, 115
Housekeeping of discs, 43
Hyphens
 hard, 95, 133
 soft, 94, 133

Identity, 128, 138
Inconsistent page size, 139
Indent, 74
Indent tab, 74
Insert layout, 134
Insert page number, 138
Inserting
 in emphasised section, 59
 hard hyphen, 137
 hard space, 137
 soft hyphen, 137
 soft space, 137
 text, 112
Inserting discs
 failure to, 141
Inspecting documents, 43
Italic, 55, 61, 136
 changing in layouts, 93

Justification, 88
 changing in layouts, 88, 92

Keeping lines together, 100, 138

Keyboard, 10
caps shift and numeric lock, 10
connecting up, 2
foreign characters, 52

Keys
accents, 52
auto-repeat, 15
for deleting text, 15
for moving the cursor, 15
textual movement, 64
used to control the PCW8256, 11
using the editing keys, 63
what character each produces, 10

Last line of page code, 101, 138

Layout menu, 134

Layouts, 78
base, 83, 102
changing, 92, 93
current, 78
editing, 79, 83, 135
editing base layout, 126
in headers and footers, 109
inserting, 134
layout number, 82
new, 92
number of, 127, 139
pitch, 92
recalling existing, 93
setting italic, 93
setting justification, 92

Left cursor, 15

Limbo, 38
recovering documents from, 44
show documents in, 44

LINE key, 64

Line pitch, 98, 99, 137
base, 98, 99

Line spacing, 98, 137

Lines
blank, 15
closing up, 20
distance between, 98
ending, 94
information, 41
keeping together, 100
last on page, 101
number blank on current page, 98
on the screen, 6
removing, 16
showing end of page, 98
splitting text into, 15, 17, 94
splitting when inserting text, 20

Lines menu, 87, 99, 137

Loading discs, 31

LocoScript
failure to load, 142

Mains supply, 1

Margins
changing, 81
shown on ruler line, 14

Maximums, 139

Maximums menu, 127

Menus
avoiding, 121
clearing options, 58
experimenting with, 25
how to avoid, 133
operation of, 12, 23, 132
selecting options, 56, 132
setting and clearing options, 132
submenus, 132
typing names of options, 132

Mistakes
correcting, 18

Mnemonics to remember codes, 122

Modes
of operation of the PCW8256, 44

Modes menu, 138
whilst editing, 105

Monitor
adjusting the brightness, 7
connecting up, 2

Moving about the screen, 18, 40

Moving blocks of text about, 69, 111, 130

Moving documents, 38, 43

Names of documents, 12, 36, 41

New page, 101

New sheet of paper, 117

Numeric lock, 10

Odd/even pagination, 140
Off-line, 116, 118
Offsets, 119
On-line, 116, 118
Options
 in disc manager, 44
Options (printer menu), 116
Orphans, 100
Overprinting, 99

Page breaks, 98
Page breaks menu, 127
PAGE key, 64
Page length, 139
Page numbers
 choose first page number, 109
 positioning of, 107
Page size, 139
Page size menu, 127
Pages, 97, 140
 controlling start of, 99
 even and odd, 106
 explicit start, 101
 first page, 108
 last page, 108
 number in document, 108
 numbering, 107
 reprinting, 117
 sizes of, 99
Pages menu, 100, 107, 108, 138
Pagination
 odd/even, 140
Pagination menu, 140
Paper
 auto-loading, 145
 dimensions of, 116
 failure to load into printer, 142
 jamming in printer, 142
 loading into the printer, 25
 mangled in printer, 117
 thickness, 145
 waiting for, 117
Paper (printer menu), 117
Paper adjustment, 146
Paper end detector, 117
Paper loading knob, 25, 115, 146

Paper out defeat, 117
PARA key, 64
Paragraph breaking, 103
 enabling, 139
 preventing, 103
Paragraphs, 17
 indenting, 74
 not splitting between pages, 99
Paste and cut, 69, 70
PASTE key, 130
PCW8256
 turning off, 8
 turning on, 4
PCW8256 Format discs, 30
PCW8256 pack contents, 1
PCW8512, ptIII
Phrases
 listing those in use, 114
 loading, 113
 on start of day disc, 114
 saving, 113
Pitch, 89, 136
 changing in layouts, 92
 line, 98, 99
Plug
 fitting a, 1
Power switch
 off, 8
 on, 4
Preparing discs, 45
Printer
 connecting up, 3
 failure, 142
 failure to load paper, 142
 loading paper, 25, 145
 maintenance, 145
 on-line and off-line, 118
 operation, 25
 paper jamming, 142
Printer control state, 115
Printer offsets, 119
Printer ribbon replacement, 147

Printing

- copy of screen, 127
- direct, 43, 115, 118
- documents, 23, 42, 115, 120
- on same line, 99
- quality, 115

Printing position, 119

Problems, 141

Proportional spacing, 89

PTR key, 115

Quick entry of codes, 121

RELAY key, 19, 65

Renaming documents, 38, 44

Reset (printer menu), 118

Resetting the PCW8256, 10

RETURN key, 15

Reverse video, 55, 61, 136

Ribbon replacement, 147

Right cursor, 15

Right justification, 88, 137

Right margin

ragged, 88

Right tab, 78

Rubbing out characters, 15

Ruler cursor, 15

Ruler line, 14

changing pitch, 91

editing, 79

Rulers, 134

visible, 80

Save all phrases, 140

Save block, 140

Saving

blocks of text, 112

Saving a document, 23

Screen

adjusting the brightness, 7

dump to printer, 127

moving about, 15

showing emphasis, 58

Searching for text, 68

Set menu, 121

SHIFT key, 10

Shift lock, 10

Shortcuts, 121, 133

Show

blanks, 84, 85

codes, 59, 100

effectors, 84, 85

ruler lines, 80

spaces, 84, 85

Show menu, 134

Sides of a disc, 28

Single sheet stationery, 116

Soft hyphens, 94, 133, 137

Soft spaces, 94, 133, 137

Software

using add-on packages, 44

Spaces, 84, 134

hard, 95, 133

soft, 94, 133

Start

failure to, 141

Start of day disc, 46

loading phrases, 114

Start printing, 115

Starting the PCW8256, 4

Style menu, 89, 136

Subscripts, 55, 61, 136

Substituting text, 71

Superscripts, 55, 61, 136

Switching off the PCW8256, 26

TAB key, 22, 74

Tab stops

shown on ruler line, 14

Tables of figures, 73, 75, 76

Tabs

centre, 78

changing, 78, 79

decimal, 76

indent, 74

number of, 127, 139

ordinary, 76

right, 78

Templates, 125

disc search order, 125

Text

aligned right, 88

centred, 87
changing the order of, 111
deleting sections of, 67
double width characters, 89
emphasising, 55
exchanging, 71
how to set out, 73
indented, 74
inserting, 19
inserting in emphasised section, 59
moving around a document, 69, 70
moving backwards through, 64
moving forwards through, 64
proportionally spaced, 89
relaying, 19, 65
right aligned, 87
splitting into lines, 17
Textual movement keys, 130
Tick used to show selection, 59
Troubleshooting, 141

Underlining, 55, 56, 135
clearing, 58

Unloading discs, 31
Unpacking the PCW8256, 1
Up cursor, 15

Vertical hold, 8

Widows and orphans, 100
enabling, 139
preventing, 103

Wiring up the PCW8256, 1
WORD key, 64

Word underlining, 55

Words
not splitting between, 95
splitting in middle of, 94
wrapping onto next line, 17, 94

Write protect holes, 29

Zeroes with/without slashes, 127, 139

Zones

header and footer, 97
text, 97

Noti

- key, 130
- menu, 133
- key, 130
- menu, 133

Important Notice

THE SOFTWARE CONTAINED IN THE DISKETTE PACKAGE IS SUPPLIED TO YOU ON THE TERMS AND CONDITIONS INDICATED BELOW. THE OPENING OF THIS PACKAGE INDICATES YOUR ACCEPTANCE OF THESE TERMS AND CONDITIONS. IF SUCH TERMS AND CONDITIONS ARE NOT ACCEPTED BY YOU, YOU MUST RETURN THE UNOPENED PACKAGE TO THE PLACE OF PURCHASE AND YOUR MONEY WILL BE REFUNDED. NO REFUNDS WILL BE GIVEN WHERE THE PACKAGE HAS BEEN OPENED UNLESS THE PRODUCT IS FAULTY AND SUCH REFUND BECOMES PAYABLE UNDER CLAUSE 7 BELOW.

In this notice, the terms:

"Locomotive" means Locomotive Software Limited

"Amstrad" means Amstrad Consumer Electronics plc

"The Program" means the programs on Side 1 of the diskettes supplied in the diskette package.

Amstrad

1. Copyright

Material within the Program is copyright Locomotive. Locomotive grants to the purchaser of this package a non-exclusive right to use the Program in accordance with these terms and conditions. Such Licence may be transferred only in accordance with Clause 3 below. Any other use or dealing not expressly authorised by these terms and conditions is strictly prohibited.

2. Use

The Program may only be used on a single machine or terminal at any one time but may be copied or merged into other programs in support of that use. Any such copying or merger is subject to there being no modification of the Program and in particular to the copyright notice of Locomotive being preserved in the copied or combined program. Save for copying or merger within other programs as aforesaid, any other operations (including modification or translation from machine readable form) are expressly prohibited.

3. Transfer

The Program may be transferred to a third party provided the original Program and all copies are transferred or otherwise destroyed and provided further these terms and conditions are produced to that third party and prior to the transfer that party agrees and undertakes to observe and continue to observe the same. Without such transfer and undertaking any application of the Program or copies thereof by any other person will not be authorised by Locomotive and will be in breach of Locomotive's copyright and other proprietary rights.

4. Documentation

The documentation accompanying the Program is also copyright Locomotive. However, no right to reproduce that documentation in part or in whole is granted by Locomotive. Should additional copies of the documentation be required for whatever reason, application must be made in writing to Locomotive which will be considered in its discretion.

5. Breach

If the user for the time being acts in breach of any of these terms and conditions it shall indemnify Locomotive against all loss suffered (including loss of profits) and the licence granted hereunder shall be deemed to be terminated forthwith. On termination the user shall deliver up to Locomotive all infringing and lawful copies of the Program.

Copyright

6. Exclusions

Neither Locomotive nor any person authorised by it gives warranties or makes representations that the program is error free or will meet functions required by the user. It shall be the responsibility of the user to satisfy itself that the Program meets the user's requirements. The Program is supplied on an "as is" basis and save as expressly provided in these conditions all warranties of any nature (and whether express or implied) are excluded.

7. Liability

Amstrad warrants that the diskette on which the Program is stored is free from material defect and through normal use will remain so for a period of 90 days after purchase. In the event of any breach of this warranty (or statutory warranty or conditions incapable of exclusion by these conditions) the responsibilities of Amstrad shall be limited to replacing the enclosed program or to returning the price paid for the same as they shall determine.

As the sole exception to the foregoing Locomotive will accept liability for death or personal injury resulting from its negligence. In no circumstance shall Locomotive be liable for any indirect or consequential costs damages or losses (including loss of business profits, operating time or otherwise) arising out of the use or inability to use the enclosed program and diskette and whether or not the likelihood of damage was advised to Locomotive or its dealer.

This notice does not affect your statutory rights.

AMSOFT

A division of

AMSTRAD

CONSUMER ELECTRONICS PLC

**CP/M Plus for the PCW8256 and PCW8512
including Dr. Logo**

© Copyright 1985 AMSOFT, AMSTRAD Consumer Electronics plc and
Locomotive Software Ltd

Neither the whole nor any part of the information contained herein, nor the product described in this manual may be adapted or reproduced in any material form except with the prior written approval of AMSTRAD Consumer Electronics plc ('AMSTRAD').

The product described in this manual and products for use with it are subject to continuous development and improvement. All information of a technical nature and particulars of the product and its use (including the information and particulars in this manual) are given by AMSTRAD in good faith. However, it is acknowledged that there may be errors or omissions in this manual. A list of details of any amendments or revisions to this manual can be obtained by sending a stamped, self addressed envelope to AMSOFT Technical Enquiries. We ask that all users take care to submit their reply paid user registration and guarantee cards.

You are also advised to complete and send off your Digital Research User registration card.

AMSOFT welcomes comments and suggestions relating to the product or this manual.

All correspondence should be addressed to: AMSOFT
Brentwood House
169 Kings Road
Brentwood
Essex CM14 4EF

All maintenance and service on the product must be carried out by AMSOFT authorised dealers. Neither AMSOFT nor AMSTRAD can accept any liability whatsoever for any loss or damage caused by service or maintenance by unauthorised personnel. This manual is intended only to assist the reader in the use of the product, and therefore AMSOFT and AMSTRAD shall not be liable for any loss or damage whatsoever arising from the use of any information or particulars in, or any error or omission in, this manual or any incorrect use of the product.

Written by Jean Gilmour, Chris Hall and Ed Phipps
Typeset by Interaction Systems Ltd
Published by AMSOFT

First Published 1985
Third Edition 1986

Dr. Logo, CP/M, CP/M Plus, GSX, DR Graph, CP/M 80, CCP/M-86 and MP/M-86 are trademarks of Digital Research Inc
Z80 is the trademark of Zilog Inc.
Z19, Z29 and H89 are trademarks of Zenith Data Systems Inc.
VT52 is the trademark of Digital Equipment Corp.
Mallard BASIC, Locomotive and LocoScript are trademarks of Locomotive Software Ltd
PCW8512, PCW8256, CPC6128, CPC684, CPC464 and DDI 1 are trademarks of AMSTRAD Consumer Electronics plc

AMSTRAD is a registered trademark of AMSTRAD Consumer Electronics plc
Unauthorised use of the trademark or word AMSTRAD is strictly forbidden

Preface

This part of the manual tells you how to use the PCW8256 (or PCW8512) as a personal computer by running CP/M Plus - Version 3 of the industry standard operating system, CP/M.

As before, text or examples which quote '...the PCW8256' are equally applicable to the PCW8512.

If necessary, you should turn back to the PCW8256 User Guide for instructions on how to set up your system, handling discs, and printer maintenance.

CP/M

The CP/M operating system makes each computer it is used on look the same to a CP/M program. Today, there are thousands of CP/M programs - everything from computer games to accountants' spreadsheets - many of which can be run on the PCW. Provided alongside CP/M Plus are two easy-to-use programming systems: Locomotive Software's Mallard BASIC interpreter (described in the Guide to Mallard BASIC, available from AMSOFT- price £ 5), and Dr.Logo - Digital Research's implementation of the LOGO programming language.

(Mallard BASIC will accept programs written for the industry standard Microsoft BASIC interpreter with little or no modification.)

The three parts to this manual cover:

The CP/M Plus operating system

The LOGO programming language

Two-Drive Operation

Each part starts with a simple introduction. This is followed by more detailed descriptions of how to do some standard tasks. Finally, reference sections are provided (where applicable).

The main contents list, given overleaf, catalogues only the principal headings of each chapter. A more detailed contents list (for Parts I and II) is given at the beginning of each part.

The licence agreements relating to the use of the CP/M system discs and the Mallard BASIC system disc permit their use only on a single computer system. You are prohibited from giving copies of these discs to any other person.

In particular, the CP/M system discs incorporate an electronically encoded serial number and you are prohibited from giving any other person a disc with your serial-numbered copy of CP/M on it.

Read carefully the End User Licence Agreements relating to these products at the end of this manual.

CONTENTS

Part I: The CP/M operating system

1 Introduction to CP/M on the PCW8256	1
2 Which commands to use	19
3 Commercial software for the PCW8256	53
4 Graphics on the PCW8256	59
5 The CP/M Plus built-in commands and utilities	67
Appendix I: CP/M Plus character sets	103
Appendix II: Advanced use of the printer	119
Appendix III: Terminal characteristics	139
Appendix IV: Error messages	143

Part II: The LOGO programming language

1 Introduction to LOGO	1
2 Starting to use Dr. Logo	3
3 A summary of Dr. Logo primitives	11
Appendix I: Primitives supported on the PCW8256	19
Appendix II: Dr. Logo error messages	21

Part III: Two-Drive Operation

1 Introduction	1
2 Discs and drives	2
3 Formatting discs for Drive B	3
4 Using Drive B with CP/M	4
5 Drive B directory	4
6 Disc files and file sizes	5
7 Copying and Verifying using DISCKIT	7
8 Using Drive B with LocoScript	8

Licence Agreement

Digital Research End User Program Licence Agreement

Locomotive Software Licence Agreement

CP/M Plus

CONTENTS

Introduction to CP/M on the PCW8256	1
1.1 What CP/M is	1
1.2 Getting started	3
1.3 Essential preparation	4
1.4 Using CP/M	6
1.4.1 Using the utilities	6
1.5 When programs need two drives	16
Which commands to use	19
2.1 Assessing the available space	21
2.2 Copying discs	22
2.3 Copying files	24
2.4 Creating files	26
2.5 Creating a Start of Day disc	27
2.6 Editing the command line	28
2.7 Editing text files	29
2.8 Erasing files	34
2.9 Finding the size of a file	36
2.10 Formatting discs	37
2.11 Listing the directory	38
2.12 Listing a file	40
2.13 Operating the printer	41
2.14 Personalising your system	46
2.15 Renaming files	48
2.16 Resetting the PCW8256	49
2.17 Shortening the command line	50
2.18 Switching which disc is read or written	52

Commercial software for the PCW8256	53
3.1 Suitable software	53
3.2 First steps	54
3.3 Running ready installed software	54
3.3.1 Turnkey operation	55
3.4 Installing the software	55
3.4.1 Running the installation program	56
3.5 PCW8256 parameters	57
Graphics on the PCW8256	59
4.1 The PCW8256's GSX software	60
4.2 GSX programs for the PCW8256	61
4.3 Using other printers and plotters	62
4.4 Errors associated with GSX programs	64
4.5 Technical information	65
The CP/M Plus built-in commands and utilities	67
5.1 Disc housekeeping	70
5.2 Setting up the hardware	87
5.3 Advanced programming tools	96
5.4 Help	102
Appendix I: CP/M Plus character sets	103
I.1 The language variants	104
I.2 Characters available under CP/M	105
I.3 Redefining the keyboard	108
I.3.1 Setting up the key definition file	108
I.3.2 Making the re-defined keyboard your standard	111
I.3.3 The supplied set of expansion strings	112
I.4 The complete character set	113
Appendix II: Advanced use of the printer	119
II.1 The Printer Control State	119
II.2 Further control of the printer	121
II.2.1 Printer control codes	122
II.2.2 Printing text	123
II.2.3 Printing graphics	124

II.3	Page layout	126
II.4	Print position changes	128
II.5	Printer initialisation	130
II.6	Typestyles	131
II.7	Special characters	134
II.8	Graphic effects	136

Appendix III: Terminal characteristics **139**

Appendix IV: Error messages **143**

IV.1	Disc handling errors	143
IV.2	Device errors	144
IV.3	CP/M Plus error messages	145

The PCW8256 keyboard under CP/M

The main keyboard

The lower character on any key and lower case letters are produced by single keystrokes. The upper character and upper case letters are produced by pressing the [SHIFT] key simultaneously.

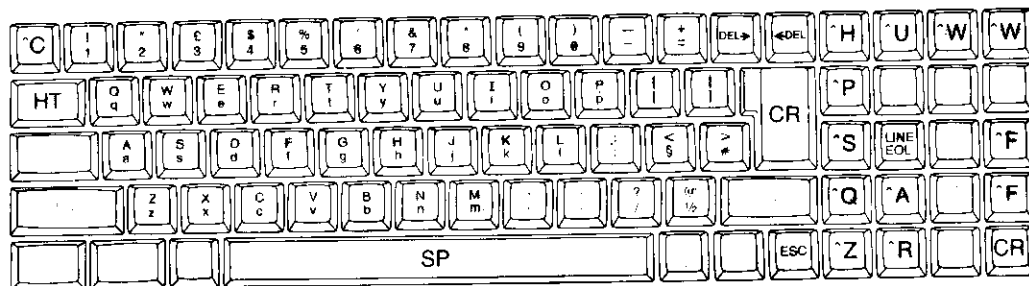

The keyboard with ALT

The lower character on any key is produced by pressing it and the [ALT] key simultaneously. The upper characters are produced by pressing the [SHIFT] key as well. The extra [SHIFT] is optional in producing the CP/M control codes (^ character).

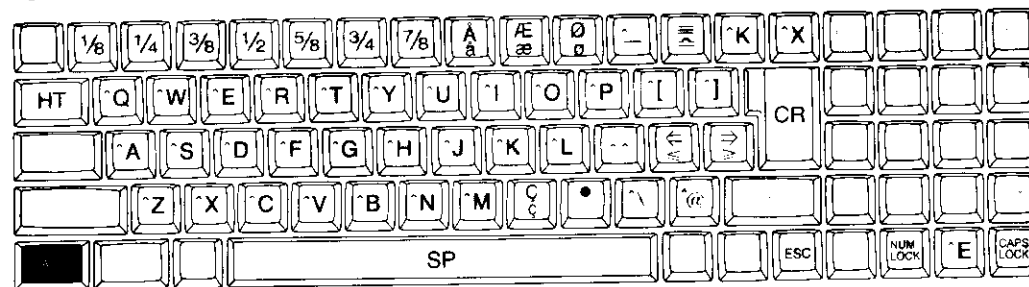

The keyboard with EXTRA

The character shown on any key is produced by pressing it and the [EXTRA] key simultaneously.

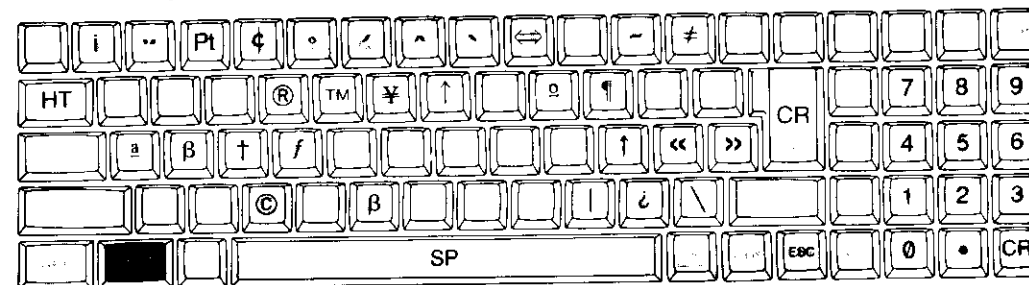

Special key combinations

[ALT] + [ENTER] acts as a Caps Lock key, setting/clearing the conversion of all lower case characters, except Greek characters, to their upper case counterpart.

[ALT] + [RELAY] acts as a Num Lock key, setting/clearing the use of a group of special keys as a numeric keypad.

[SHIFT] + [EXTRA] + [EXIT] resets the computer.

Introduction to CP/M on the PCW8256

An alternative to LocoScript on the PCW8256 is CP/M Plus – Version 3 of the industry standard Control Program for Microcomputers, CP/M. Running the PCW8256 with CP/M Plus converts it into a powerful general purpose microcomputer.

CP/M makes each computer on which it is used behave in the same way and the PCW8256 is by no means the only computer to run CP/M. As a result, the PCW8256 user has many thousands of software packages from which to choose – everything from games to accountants' spreadsheets.

If you want to write your own software, then you will also find included two easy to use programming systems: Locomotive Software's Mallard BASIC interpreter and Dr. Logo, Digital Research's implementation of the LOGO programming language. Mallard BASIC will accept programs written for the industry standard Microsoft BASIC interpreter with little or no modification.

Mallard BASIC is on Side 2 and Dr. Logo is on Side 4 of the PCW8256 system discs.

We should point out that none of the menus and other user friendly features of the PCW8256 when it is working as a word processor are available when the PCW8256 is running CP/M. These features are unique to LocoScript. What sort of help you get while you are using CP/M programs will depend on the software you run.

We should also point out that the actions that some of the keys have when you run CP/M are different from those they had while you were using LocoScript. They change again when you run Dr. Logo and Mallard BASIC. So always refer to the keyboard layout opposite when running CP/M.

1.1 What CP/M is

CP/M is an operating system which means its job is to run programs and help you organise your data.

To do this, it has some special programs called the CP/M commands. These come in two groups, built-in commands and Transient Utility Programs -- or Utilities for short. The built-in

commands are automatically read into the PCW8256's memory every time the CP/M operating system is loaded and they are always available to you. The utilities are stored on the system discs and have to be loaded into the PCW8256's memory each time they are used.

Both programs and data are stored in Files, and to run a program what you have to tell CP/M is the name of the file holding the program you want to run. Often you also have to give CP/M the name of the file holding the data the program is going to manipulate for you.

You give CP/M all this information by typing in what are known as Command Lines. These always start with the name of the file holding the program you want to run – which could be one of the CP/M commands or a utility.

CP/M identifies files by a two-part name. The first part is called the Filename and the second part the Filetype.

The filename can essentially be any combination of up to eight characters, though you can't use certain special characters:

< > = ! | * ? & / \$ [] () . : ; \ + -

Often just the letters of the alphabet A..Z and the digits 0..9 are used.

The filename will usually have been chosen to suggest what the file contains but this doesn't have to be so.

The filetype is up to three characters long, and again the characters recommended are A..Z and 0..9. But unlike the filename, the filetype can be fixed by the sort of operations that can be done using the file.

When typing in your command line, you will always have to give the filename and often you will have to give the filetype as well. If so, the way to type this is the filename, followed immediately by a dot, followed immediately by the filetype. For example, if the file you want to specify has the filename MYFILE and the filetype TXT, you would type MYFILE.TXT in your command line.

The other piece of information you may have to give CP/M is a letter that tells it which disc holds the file you want.

CP/M can cope with up to 16 drives, which it calls A, B,..P. So, for example, if MYFILE.TXT is on Drive B, you might have to type B:MYFILE.TXT. The B: tells CP/M to look on the disc in Drive B.

At any one time, CP/M calls one of these drives its Default Drive and you don't need to give the drive letter with files on the disc in that drive. This is usually Drive A but you can change it as we shall describe later.

1.2 Getting started

Before you can run any application program under CP/M Plus on the PCW8256, the computer has to read CP/M off the CP/M system discs into its memory. The PCW8256 loses the information it needs to run CP/M programs each time it is switched off or reset.

As you will find yourself changing the disc in the drive quite often while you run CP/M, you should remind yourself of the rules about handling discs given in chapter 2 of the User Guide. In particular, remember that you should **never** remove a disc while the light on the disc drive is on or flashing on and off: that could damage your disc, let alone the data on it.

The steps involved in loading CP/M into the PCW8256 (the process often referred to as 'booting CP/M') are as follows:

Start by checking that there is no disc in the drive: then turn the machine on.

Select Side 2 of the system discs, inserting the disc into the drive with this side to the left.

Press the space bar. If all is well, you should see a pattern of green and black horizontal lines build up on the screen. The screen then displays a message like:

```
CP/M Plus Amstrad Consumer Electronics plc  
v 1.4, 61K TPA, 1 disc drive, 112K drive M:  
A>█
```

The second line just outlines what hardware you have available, while the A> that precedes the oblong is called the System Prompt. This tells you that CP/M is ready to receive a command.

The A> also tells you that the current Default Drive is Drive A. If the default drive is ever changed, for example to Drive B, the system prompt will also change in this case to B>

The oblong is called the Cursor and its position marks where the next character you type in will appear on the screen.

If you get a completely different message in particular, if you appear to go into the LocoScript system release the disc and check that you inserted the disc you intended and that you inserted it the right way round. Put the disc in the drive again, hold down [SHIFT] and [EXTRA] and then press [EXIT]. Finally press the space bar to tell the PCW8256 to read the disc again.

If the disc is damaged in any way or there is no CP/M operating system on the disc, the screen will flash as the PCW8256 attempts to read it. After a few unsuccessful attempts, the computer will beep before switching the disc drive motor off. The screen is left bright all over.

The other thing to note about this loading process is that the printer is now set up to handle single sheets of A4. If this isn't the sort of paper you want to use, turn to 'Operating the printer' (section 2.13) **before** you use the printer.

1.3 Essential preparation

The next thing to do, if you haven't already done so, is to make a second set of system discs. You will use this second set to run CP/M programs and keep the originals safely stored away, to use only if your 'Working' set gets damaged.

You will need two new blank discs for this second set because you will be copying a total of four sides.

Copying a disc means copying all the data from one disc onto another in such a way that the second disc is identical to the first.

On the PCW8256, the program that does this is called DISCKIT. This program is easy to use because all you have to do is follow the instructions on the screen.

Still keeping Side 2 of the system discs in the drive, type:

DISCKIT

(You will see the characters appear on the screen after the A> prompt.) Then press the **[RETURN]** key.

Up on the screen will come a set of messages first telling you to remove your disc, then offering you the choice of Copy, Format or Verify (or Exit from DISCKIT) and showing you which key to press to select each option. In this case, you want Copy, so press the **[F5]** key.

The order in which you copy the sides doesn't matter, but it will be simpler to keep track of what you have done if you copy the sides in order from Side 1 to Side 4.

Assuming you are NOT operating a 2-drive system, the next message that appears asks you to '...put the correct side of the disc you wish to READ into the drive, then press Y'. If this is the message you see on the screen, then simply insert the disc you want to copy from (in this case Side 1 of the system discs), and type Y.

(If you ARE operating a 2-drive system, you will be asked which drive you want to read from (press [*f*] for Drive A - the upper drive, or press [*f*] for Drive B - the lower one); you will then be asked which drive you want to write to (press [*f*] for Drive A, or press [*f*] for Drive B). Only after that will you be asked to insert the disc to READ and type Y).

If you are using a PCW8512 (or a PCW8256 with a second (FD-2) drive fitted), full details of 2-drive operation (including DISCKIT) will be found in Part III of this manual (towards the end).

After you have typed Y, copying will take place. You should note that copying is a two-part process, and after a short while, you will see the message:

```
Insert disc to WRITE:  
Press any key to continue
```

(This message may not appear if you are copying on a 2-drive system.)

Release the system disc from the drive and insert one of the new discs with the side you want to copy the data onto to the left.

After another short while, you will see the message:

```
Insert disc to READ:  
Press any key to continue
```

and you must again re-insert the original system disc you are copying from so that the second part of the copy can go ahead. After you have again changed discs (as instructed on the screen) you will eventually see the message:

```
Copy completed  
Remove the disc from the drive
```

If you accidentally mix up the disc you are reading from (the Read disc) and the disc you are writing to (the Write disc), DISCKIT will spot this and display an appropriate message.

Any error messages that appear should also be self explanatory, but if you feel in need of extra help, refer to Chapter 5 where full details of the DISCKIT utility are given.

Once the process of copying that side has been completed, release the disc from the drive and write 'Working system disc - Side 1' on its label.

DISCKIT then gives you the option of copying another side. Copy the other three sides onto the remaining unused sides of new discs one by one until all have been copied.

Once you have made your duplicate set of system discs, store your Master discs safely away somewhere where they will be away from any magnets - including the ones in your television, audio equipment and your PCW8256 - and where they won't get excessively hot, cold, damp or dirty.

1.4 Using CP/M

In principle, you now know enough about CP/M to run any well documented CP/M program.

Unfortunately, in practice, this will not always be the case. We give advice on how to go about choosing the software to buy in chapter 3 but, even so, you are advised to spend some more time learning about CP/M itself. Then, you'll be able to get the CP/M application software you buy working that much easier.

The rest of this introduction takes you through some simple uses of CP/M. Although you can just read it, we suggest that you work through the instructions using the PCW8256 as it will get you used to how CP/M works and how it differs from LocoScript.

1.4.1 Using the utilities

The PCW8256 is supplied with more than 30 utilities, with the more commonly used ones on Side 2 of the system discs. Some of these utilities extend a similarly named built-in command to give that command extra features.

As we described earlier, you give instructions to CP/M by typing in what are known as Command Lines.

These must be absolutely correct if they are to have the right effect but it doesn't matter if you make a mistake while typing in the line: just use the [←DEL] key to rub out what you have typed back to where you made the mistake, and then type it in again from that point.

At the end of each command line, press the [RETURN] key: this sends the instructions to CP/M. We will remind you to do this throughout this introduction by putting [RETURN] at the end of each command line we suggest you type in. But in line with almost every reference book on CP/M, these are omitted in the more advanced parts of the manual.

Command lines will only be obeyed if they are typed when CP/M is ready to receive a command, which it shows by putting a system prompt (for example, A>) on the screen.

The rest of this section is designed to help you learn what instructions to give CP/M.

What's on your discs

The first thing you will want to know about any disc you put in the drive is what files are on each side of the disc.

The names of all the files on one side of a disc are held in a Directory and you look at the contents of the directory with the aid of DIR, one of the built-in CP/M commands.

Put Side 2 of your system discs back in the drive. To see the names of the files on this disc type in the instruction:

```
DIR [RETURN]
```

after the A>

CP/M never distinguishes between lower case and upper case letters so you can use whichever you prefer. You don't even have to be consistent.

Up on your monitor screen will come:

```
A>dir
A: J10CPM3 EMS : BASIC COM : DISCRIT COM : LANGUAGE COM : DIR COM
A: PAPER COM : SET24X80 COM : SETKEYS COM : TYPE COM : SETLST COM
A: SETSIO COM : KEYS MP : ERASE COM : PIP COM : RENAME COM
A: SET COM : SETDEF COM : SHOW COM : SUBMIT COM : RPED BAS
A: PROFILE ENG : ED COM : RPED SUB
A>
```

The leftmost column is full of 'A':s because the disc is in the drive CP/M has named Drive A.

The rest of list is alternate columns of filenames and filetypes, starting with filenames. Each filename goes with the filetype immediately to its right - so J10CPM3 and EMS is one file, BASIC and COM another, and so on.

The filename of a file never reflects the sort of operations that can be done using the file but the filetype can.

For example, you will see that most of the files listed on the screen have the filetype COM. This means that the file holds a program that CP/M can run. Other special filetypes in this list are BAS, meaning that the file contains a BASIC program, and EMS. The EMS file is the one that contains CP/M.

Much of the time, you will be interested, not so much in what files are on a disc, but in whether the file or files you want are on the disc. The DIR command can also do this for you.

Suppose you want to see if you have a file with the filename RPED and the filetype BAS on this disc. The command line that does this is:

```
DIR RPED.BAS [RETURN]
```

Notice that we have quoted the name of the file by putting its filename and then its filetype, separated by just a dot.

The response on the screen will be:

```
A: RPED BAS
```

If the file hadn't been on the disc, you would have seen the message:

No File

If you had known that the filename of the file you wanted was RPED but you couldn't remember its filetype, you could have used the DIR command to list out the whole directory as before. A better solution would have been to give DIR a template and instruct it to search through the directory for all the files that match the template.

Templates are constructed using the Wildcards * and ? – an asterisk represents any number of characters but a questionmark only represents a single character.

The template for all the files with the filename RPED is RPED.* and so the command line you would type in is:

```
DIR RPED.*[RETURN]
```

What will appear on the screen is:

```
A: RPED      BAS : RPED      SUB
```

which tells you that DIR has found two files matching the template, RPED.BAS and RPED.SUB.

You would use a similar template if what you wanted listed out was all the program files on the disc. This time we would use an asterisk instead of any filename and type:

```
DIR *.COM[RETURN]
```

You would also use an asterisk in the template if you knew just the first few characters of either the filename or the filetype or if you wanted to list all the files with the same few characters at the start of their filenames.

Say, for example, that you wanted DIR to list out all the files on the disc that have filenames starting with R, regardless of their filetype. The command line that does this is:

```
DIR R*.*[RETURN]
```

Notice that you have to use two asterisks: one for the filename and one for the filetype.

So far, we have just described how to use the asterisk wildcard. You would use the questionmark wildcard if, for example, the files you wanted listed out all had filenames starting with PR but no more than five characters.

Suppose you want all these files whatever their filetype. The command line you would need is:

```
DIR PR????.*[RETURN]
```

We will tell you shortly of some other uses of wildcards and how these will often save you a lot of typing.

The 'Memory Disc'

A special feature of CP/M on the PCW8256 is that you can use part of the PCW8256's memory as a disc – the Memory Disc. As far as CP/M is concerned, the memory disc is just like any other disc: it just happens to be permanently in the drive it knows as Drive M.

Operations involving the memory disc are very fast. However, you will lose everything you store there every time the machine is switched off or reset.

You can find out about the disc in another drive by making that drive the default drive. The command line that changes the default drive to Drive M is:

```
M: [RETURN]
```

CP/M will respond by changing the system prompt M>

You can now find out what files are stored in the memory disc by typing:

```
DIR [RETURN]
```

Up on the screen will come:

```
No file
```

because so far you haven't stored any files there.

That being the case, there is not much point in keeping Drive M as the default, so go back to Drive A by typing:

```
A: [RETURN]
```

In fact, you could have found out what was in the memory disc without changing the default drive. The command line you would use is:

```
DIR M: [RETURN]
```

Alternatively, you could have checked if a particular file – say, FILE.TYP – was stored in the memory disc by typing:

```
DIR M:FILE.TYP [RETURN]
```

The **M:** that we have been using in these command lines is the final element in what is known as a file's File Specification, which indicates precisely which file you want by its location as well as its filename and filetype.

We could have put an **A:** in front of all the filenames we have given so far but the whole point of CP/M nominating a drive as the default drive is to save you the effort of giving the location when the file is on the default drive.

Later, when you use CP/M for real, you will probably store copies of the utilities you want to use in the memory disc. Then you won't have to change the disc in the drive merely because there is no copy of the utility you want on the same disc as the program you are running. We will tell you how to set up these copies in the next section.

Copying files

The CP/M utility that makes copies of files is called PIP.

The information you give PIP is the name of the file you want copied (the Source) and the name of the file you want the copy stored as (the Destination).

PIP will proceed to make the copy, provided that no file already exists with the same file details as the proposed Destination file and provided that there is enough room on the disc for the new file.

To illustrate how the PIP utility works, we will copy the file called PROFILE.ENG and store the copy as the file TEMP on the same disc as the Source file. The command line to type in is:

```
PIP TEMP=PROFILE.ENG[RETURN]
```

Notice that you give PIP the details of the Destination file, before you give it details of the Source file.

Test that this new file now exists by typing:

```
DIR TEMP[RETURN]
```

You can also use PIP to copy between drives. To demonstrate this, we will once again make a copy of PROFILE.ENG but this time we will store the new file, TEMP, on the memory disc, which you will remember is Drive M.

The command line to do this is:

```
PIP M:TEMP=PROFILE.ENG[RETURN]
```

Now you have that copy on the memory disc, you can make another copy of the same file, but this time using the copy on the memory disc as the Source. The command line to type in is:

```
PIP TEMP2=M:TEMP[RETURN]
```

The above examples have all just copied one file. You can also use PIP to copy a number of files at once. However, you must want to copy all these files to a different disc and to store them there under their present filenames and filetypes.

You instruct PIP to copy the files by giving it a template that picks out just the files you want – in exactly the same way as you earlier used a template with the DIR command.

For example, you could in theory (but don't try just yet) make copies of all the utilities on Side 2 of the system discs on the memory disc with the command line:

```
PIP M:=*.COM[RETURN]
```

However, at least in a standard PCW8256, there wouldn't be room on the memory disc for all these files.

The process of getting copies of the utilities you need on the memory disc certainly involves the PIP utility but, as you can imagine, typing in a long sequence of PIP commands is a fairly laborious job. Fortunately, there is a neat way of getting those copies made which we will come to later in this introduction.

Organising your discs

As well as letting you copy files, CP/M helps you to rename them or erase them from the disc.

All these operations are often referred to as Disc Housekeeping. As you use CP/M more, you will find you need these quite often.

The CP/M command to use to rename files is called RENAME – often abbreviated to REN. This command works purely on the directory of a disc, substituting the new filename and filetype for the old ones. The data itself is not changed.

You can change the name of a file as many times as you want. All you have to give RENAME is first the new name and then the old.

We shall illustrate this by changing the name of the file you just created, TEMP2, to TEMP.2. The command line that does this is:

```
REN TEMP.2=TEMP2[RETURN]
```

In this case, the command alters the directory on the default disc. To rename a file on a disc in a different drive, you just need to add the drive letter – which obviously should be the same for both the new name and the old.

To demonstrate this, we shall change the name of the file called TEMP on the memory disc to FILE.NEW. The command line to type in is:

```
REN M:FILE.NEW=M:TEMP[RETURN]
```

So far, we have only described changing the name of one file. Templates like the ones you set up for use with the DIR and PIP commands can also be used with RENAME. However, the way you use wildcards in the new file specification must be identical to the way you use them in the old.

For example, to change the names of the two files, TEMP and TEMP.2, on the default drive to NEW and NEW.2, the command line to type in is:

```
REN NEW.*=TEMP.*[RETURN]
```

A command line like:

```
REN NEW.*=TE*.*[RETURN]
```

would fail.

You erase any files you no longer need with the ERASE command – often abbreviated to ERA.

To show how to use the ERASE command, we shall erase the file on the memory disc – the one you have just renamed FILE.NEW. The command line that does this is:

```
ERA M:FILE.NEW[RETURN]
```

Once again, the location part of the file specification has been included because the file is not on the default drive.

The ERASE command also allows you to set up a template with wildcards and so use just one command line to erase a number of files.

This should be used with care. There is no limbo for files under CP/M – that is a special feature of LocoScript and so files once erased cannot be restored.

However, there is an extra feature of the ERASE command that ensures that none of the files that fit the template are erased until you confirm that you want this done.

We shall illustrate this by using this feature to erase the two files, NEW and NEW.2, on Drive A. The command line to type in is:

```
ERA NEW.* [C][RETURN]
```

The [C] tells CP/M that you want to use the 'Confirm' or 'C' Option of the ERASE command.

A number of the CP/M commands and utilities have Options, which we cover mainly in the reference sections of this manual. They are always specified by putting their name between square brackets at the end of the command line.

In this case, what you will see on the screen after typing in this command is:

```
ERASE NEW (Y/N)?
```

Type Y[RETURN] to confirm that you want this file erased.

You will then get a similar message about NEW.2.

File sizes

Before you can say whether there is enough room for a file on a disc, you need to know three things - how big the file is; how much free data space there is on the disc; and whether there is room in the directory for its name. The directories on PCW8256 discs can't hold more than 64 names. (For directory and file sizes on a 2-drive system, see the sections entitled 'Drive B directory' and 'File sizes' in Part III of this manual (towards the end.)

You can find out how big the PROFILE.ENG file is through the command line:

```
DIR PROFILE.ENG [SIZE][RETURN]
```

What this does is to use an extra feature of the DIR command provided by the DIR utility - the SIZE option. DIR searches through the directory as before but this time it displays, not just the filename and the filetype, but the size of the file as well.

Notice the space between the last character of the filetype and the first square bracket.

What should now be on your screen is:

```
A: PROFILE ENG      1k
```

This tells you that PROFILE.ENG occupies 1k of disc space and so there will have to be at least 1k of free space on the disc if you are to put a second copy of this file on it.

The disc in the drive can store up to 173k of data, while the amount the memory disc can hold depends on how much memory your PCW8256 has.

The 'k' here stands for Kilobyte and it is the unit in which disc space is always measured. It corresponds to roughly 1000 characters.

The next thing to do is to find out how much free space there is on these discs. The utility to use here is SHOW and the command line you need is:

```
SHOW [RETURN]
```

Up on the screen will come something like:

```
A: RW, Space:      11k
M: RW, Space:     111k
```

which tells you that the amount of free space on the disc is 11k, which is plenty to hold a second copy of PROFILE.ENG, and that the corresponding figure for the memory disc is 111k. The 'RW' tells you that the PCW8256 is allowed to both read from and write to discs in Drives A and M.

The fact that the status of the drive is RW is no guarantee that you will be able to write to the disc in the drive. If the Write Protect Hole is open, you will always be prevented from writing to that disc and from erasing or renaming any of the files.

The remaining check is that there is room in the directory for the new filename. The maximum number of names that can be held in the directory is 64 and once that number has been reached, no more files can be written onto the disc, however much free space there is available on the disc.

SHOW is again the utility to use, but this time with one of its options. The command line to use is:

```
SHOW A:[DIR] [RETURN]
```

Up on the screen will come:

```
A: Number of free directory entries:  38
```

That confirms that you have both plenty of space and plenty of room in the directory for the new file.

So far, you have been using the CP/M commands to manipulate PROFILE.ENG without knowing what this file contains. You can find out with the aid of another built-in command. TYPE

The command line that lists out its contents is:

```
TYPE PROFILE.ENG [RETURN]
```

If you do this, you will see that each line of the file is rather like the commands you have been typing in yourself. We will explain why next.

Some shortcuts to take

A useful facility of CP/M is that it lets you put a number of command lines into a file and then just type one command line to get exactly the same effect as typing all the commands in separately.

The command you type in uses the SUBMIT utility and the file holding the command lines must have the filetype SUB.

To make use of the commands stored in PROFILE.ENG, you have first to change its filetype to SUB by using the RENAME command. So type:

```
REN PROFILE.SUB=PROFILE.ENG[RETURN]
```

Then type:

```
SUBMIT PROFILE[RETURN]
```

and you will see it all happen. (You don't have to give the filetype because it has to be SUB.)

It will take a little time because most of the operations copy fairly large files to the memory disc.

PROFILE.SUB is a special SUB file. It is accessed by a SUBMIT command embedded in the file that loads CP/M, and the command lines within it will always be obeyed every time you load CP/M.

If you now type in:

```
DIR M:[RETURN]
```

you will see that a number of files have been loaded into the memory disc.

If you leave this file as PROFILE.SUB, these utilities will be copied onto the memory disc every time you run CP/M Plus.

The other command line in the file uses the SETDEF utility to instruct CP/M to look for its utilities on more than one drive. This is another useful shortcut provided by CP/M.

The particular form used here:

```
SETDEF M:,*
```

tells CP/M to look first on Drive M and then on the default drive. (The use of an asterisk to represent the default drive is special to the SETDEF utility.)

A final shortcut to mention here are the keystrokes you can use to save effort in typing in and correcting command lines.

Rather than use the [←DEL] key to move back to any part of the command line you want to correct, you can use the cursor keys [←] and [→]. You can then use the [DEL→] and [←DEL] keys to erase characters and type in any new characters you want at the cursor position, before moving the cursor back to the end of the line.

You can also use the [COPY] key to recall the previous command line. This is covered, alongside details of other editing shortcuts, in the section on command line editing (section 2.6).

Your PCW8256 is now well set up for working with CP/M application programs. Chapter 3 contains advice on buying and running software, while Parts II and III of this manual tell you about writing and running BASIC and LOGO programs.

From time to time, you will need to check up on how CP/M itself operates. For this, we have provided chapter 2, the separate sections of which describe how to carry out particular actions – including setting up the printer.

1.5 When programs need two drives

The PCW8256 with just one disc drive attached is capable of running commercial application programs that were written assuming that the user would have access to two disc drives.

The way it does this is to pretend to CP/M that there are really two disc drives called Drive A and Drive B. CP/M then alternates between addressing the drive as Drive A and addressing it as Drive B, according to the needs of the application program.

The moment the drive is changed from Drive A to Drive B, the message in the bottom right-hand corner of the screen changes to Drive is B and you will get a message asking you to swap the disc currently in the drive for the disc that would be in Drive B if you had a second drive.

Similar messages appear when the drive is changed from Drive B to Drive A.

You can get a feel for how this works using the PIP utility to create a copy of GENGRAF.COM on Side 2 of the system discs. GENGRAF.COM is currently on Side 4.

In this example, the disc to put in 'Drive A' is Side 2 and the one to put in 'Drive B' is Side 4.

Start with the first system disc in the drive with Side 2 to the left. The command line you need is:

```
PIP A:=B:GENGRAF.COM[RETURN]
```

This tells CP/M to make a copy of GENGRAF.COM, which it will find on the disc in Drive B, and to store the copy under the same name on the disc in Drive A.

The first message you will get is:

```
Please put the disc for B: into the drive and press any key
```

Release the disc from the drive and insert the second system disc in the drive with Side 4 to the left. Press, say, the space bar. The computer then reads GENGRAF.COM into its memory.

It then puts up the message:

```
Please put the disc for A: into the drive and press any key
```

Release the disc from the drive and re-insert the first disc. Press the space bar and the computer will put the copy it has made on this disc.

You can check that this has been done by typing:

```
DIR GENGRAF.COM[RETURN]
```

Although copying files from one disc to another can be done using just Drives A and B in this way, we would always recommend using Drive M as an intermediary storage area, ie copying the file first onto the memory disc, changing the disc in the drive and then copying the file from the memory disc to the new disc in the drive.

Which commands to use

This chapter goes through one by one the things you are likely to want CP/M to do for you. It is not an exhaustive list of what the CP/M commands and utilities do.

Each section covers one general activity in more detail than was possible in chapter 1. It describes the commands you will need and how to use them for the job in hand. If you need to know more about a particular command or utility, you can look it up in chapter 5.

The topics covered are:

- Assessing the available space
- Copying discs
- Copying files
- Creating files
- Creating a Start of Day disc
- Editing the command line
- Editing text files
- Erasing files
- Finding the size of a file
- Formatting discs
- Listing the directory
- Listing a file
- Operating the printer
- Personalising your system
- Renaming files
- Resetting the machine
- Shortening the command line
- Switching which disc is read and written

Throughout this chapter, we assume that the utility you require for any command is either on the disc in the default drive or that you have set the disc search order (see section 2.17) so that the utility is automatically found.

If neither is the case, you will have to include the drive the utility is on as part of its name. For example, you may have to type:

```
M:PIP M:=file
```

to copy a file on the default drive into the memory disc, if the copy of PIP you want to use is on the memory disc.

Conventions

Metalinguage This chapter uses words printed in *italic* to represent parameters that you will have to specify. For example, *drive:* should be replaced in your command line by A:, B: or M: (or omitted if the required drive is the default drive), while *file* should be replaced by as much of the file's full specification (*drive: filename. filetype*) as is needed to identify the file.

The terms used are always explained in the text accompanying the command line and supported by examples.

Control codes are given as 'Control-*character*'. This is to be consistent with other guides to CP/M. There is no Control key on the the PCW8256 keyboard.

The key to press will often be one of the special function keys but `[ALT]` + *character* will always work as well. The actions of the special function keys are listed in section 2.6 'Editing the command line'.

Internal codes are given in two forms. One way is as a decimal number; the other is as a Hexadecimal number. Hexadecimal numbers are to the base 16 and are made up by a # followed by two characters. Each of these characters can be one of the digits 0..9 or one of the letters A..F

2.1 Assessing the available space

The easiest way of finding out how much free space there is on a particular disc is to use the SHOW utility.

The simplest form of SHOW displays the free space on all logged-in discs, along with what types of access are allowed to that disc. For example, the screen could look like this:

```
A>SHOW
A:  R0, Space: 4k
M:  RW, Space: 58k
```

This tells you that the discs currently logged in are the one in Drive A and the memory disc and that while you are allowed to read from and write to the memory disc, you may only read from the disc in Drive A. (RW stands for Read-Write; R0 for Read-Only). It also tells you that you have 4kilobytes of free data space on the disc in Drive A but 58kilobytes still free in the memory disc.

You can display just the information about one particular disc by typing, for example, SHOW M: The screen display would then be:

```
A>SHOW M:
M:  RW, Space: 58k
```

If you want to find out the number of free directory entries on a particular disc and thus the maximum number of new files you could store on that disc, the command to use is

```
SHOW drive: [DIR]
```

For example, the screen could look like this:

```
A>SHOW A:[DIR]
A: Number of free directory entries: 12
```

2.2 Copying discs

Making copies of discs on the PCW8256 involves using the DISCKIT utility. If necessary, DISCKIT will also format the disc being written to as part of the copying process.

DISCKIT presents menus to help you select the correct options for the job you want to do and puts up messages to tell you what to do or to advise you of any errors that have occurred.

Before you start copying, check that the Write Protect Holes on your system disc and the discs you intend to copy are open so that you cannot spoil them by accidentally writing to the disc. (There is a diagram in chapter 2 of the User Guide showing the position of the Write Protect Holes and how they open and close.)

Start with your CP/M system disc in Drive A with Side 2 to the left or with DISCKIT copied onto the memory disc.

Then type DISCKIT after a system prompt. This brings up the first set of messages, which offer the choice of Copy, Format or Verify (or Exit from DISCKIT), and tell you which function key to press to select the desired action. In this instance, you want Copy ie the `[F5]` key.

If you have just one disc drive, the next screen merely asks you to type Y to confirm that you want to copy the contents of one disc to another. Remove the system disc from the drive.

If your system has two disc drives, the next screen will ask which drive you want to read from (press `[F5]` for Drive A; `[F1]` for Drive B). This is followed by a message asking which drive to write to (press `[F5]` for Drive A; `[F1]` for Drive B). You will then be asked to type Y to confirm that this is what you want to do. Remove the system disc from the drive.

The next set of messages prompt you to put the right disc in at the right time. They are designed to be self explanatory: for example, if the PCW8256 needs a disc to be inserted in a particular drive, you will see a message like:

```
Insert disc to READ
Press any key to continue
```

or

```
Insert disc to READ in B:
Press any key to continue
```

Put the disc to be copied into the drive with the side you want copied to the left. When the corresponding WRITE message appears, insert the disc you want to copy to with the appropriate side to the left.

If in swopping discs in and out of a single disc system, you mix up the disc you are reading from with the disc you are writing to, DISCKIT will display an appropriate message and allow you to change to the correct disc before continuing.

Any error messages that appear should also be self-explanatory, but if you feel in need of extra help, refer to chapter 5 where full details of the DISCKIT messages are given.

Once the process of copying one side has been completed, DISCKIT tells you to remove all discs from the drives and then gives you the option of copying another. If this is what you want, type Y and go through copying the discs a side at a time until all have been copied.

2.3 Copying files

The utility that makes a copy of a file either on the same disc or on a different disc is the Peripheral Interchange Program, PIP.

As you might suppose from its full title, this utility is used for many more actions than just copying files from disc to disc. Details of all the variants are given in chapter 5.

The basic command needed to copy files is:

```
PIP destination=source
```

where *source* represents the name of the file to be copied and *destination* the name of the new file which is created to hold the copy.

This command will work whatever the details of the file you want to copy and wherever you want to store the new file.

For example:

```
PIP NAME.TXT=MYNAME.ADR
```

makes a copy of a file on the default drive called MYNAME.ADR and stores it on the default drive as NAME.TXT.

```
PIP M:ABC.COM=A:XYZ.COM
```

makes a copy of the file on Drive A called XYZ.COM and stores it on the memory disc as ABC.COM.

If, however, you want to copy the file to a different disc but retain the original filename and filetype, there is a shorter command you can give:

```
PIP destination-drive:=source
```

For example:

```
PIP M:=MENU.COM
```

makes a copy of a file on the default drive called MENU.COM and stores it on the memory disc also as MENU.COM.

```
PIP M:=A:USEFUL.SUB
```

makes a copy of a file on Drive A called USEFUL.SUB and stores it on the memory disc also as USEFUL.SUB.

This instruction can't be used to make a second copy of a file on the same disc because you can't have two files with identical filename and filetype on the same disc.

As a general rule, if the destination file already exists, the old file contents are erased as part of the copying process.

In common with many other CP/M commands, PIP allows you to use wildcards to reduce the number of instructions needed to copy a number of files from one disc to the other.

The characters that can be used as wildcards are * and ?

An asterisk is used to represent any valid group of characters. It can replace a whole filename or filetype or complete a filename or filetype when you quote the character(s) that start it.

A questionmark can only represent a single character or blank in the same position as itself.

For example:

PIP M:=A:* .COM

 makes copies on the memory disc of all the .COM files on Drive A.

PIP M:=A:*.*

 makes copies on the memory disc of all the files on Drive A.

PIP M:=A:PROG??.*

 makes copies on the memory disc of all the files on Drive A whose filenames have no more than six characters and start PROG.

PIP M:=A:PROG*.*

 makes copies on the memory disc of all the files on Drive A with filenames starting PROG.

These versions of the PIP instruction cannot be used to produce copies of a file on the same disc as the original.

2.4 Creating files

There is more than one way of creating a new file under CP/M. The ways we suggest here use the various text editors supplied with the PCW8256.

These have their own ways of handling the characters you type in, so follow the instructions carefully.

The first thing to do is to check that there is enough room for the new file on the disc you propose to use. Use the `SHOW` command for this (see section 2.1).

If the file you propose to create is less than 20k (approximately 20,000 characters), you can use the supplied BASIC text editor, `RPED`. This displays a constantly updated version on the screen and allows you to use the cursor keys etc to move around the text and edit it.

If your system uses the supplied `PROFILE.SUB`, just type `RPED` after a system prompt and then follow the instructions that appear on the screen. If not, you will first need to put Side 2 of the system discs in the drive.

Another way is to use the CP/M text editor `ED`. This is on Side 2 of the system discs.

To open the edit, type:

```
ED file
```

where *file* stands for the name of the new file.

ED will respond with:

```
NEW FILE  
: *
```

The asterisk is ED's prompt and shows that ED is waiting for one of its commands.

If all you want is an empty file with a suitable filename, simply type `E` to leave the text editor.

If you want to put text into the new file, type `i`. This takes you into ED's Insert Mode and you may then just type in whatever you want. The code to leave Insert Mode is 'Control-Z', so press [`ALT`] - `Z`. Return to CP/M by typing `E`.

If while typing in a line of data you make any mistakes, use [`DEL`] to rub out characters back to the mistake. If you don't notice the mistakes until after you have left the line, turn to section 2.7 where we describe editing text files.

2.5 Creating a Start of Day disc

The idea of a Start of Day disc is that putting this disc in the drive immediately after you switch on sets up the PCW8256 ready to run your applications programs.

It therefore needs to hold a copy of the file containing the CP/M operating system (J10CPM3.EMS), a copy of each of the utilities you use often and a PROFILE.SUB file that copies these utilities into the memory disc and makes them readily accessible to CP/M.

The way to create such a disc for yourself is to use the DISCKIT utility to duplicate Side 2 of the system discs on a fresh disc (see section 2.2). This immediately gives you a disc that you can use both as a Start of Day disc and as a source of utilities such as DISCKIT that you don't copy into the memory disc. If you wish, you can use the ERASE command to erase any files you won't need.

2.6 Editing the command line

You can always use the [←DEL] key to rub out characters when you make a mistake or change your mind about the command you want to execute.

However, CP/M Plus provides some short cuts to getting the command line typed in correctly – including using an earlier command as part of the current command.

These short cuts are taken by pressing particular keys or combinations of keys on the PCW8256 keyboard. The keys you want are as follows:

- [←] to move the cursor back one character
- [→] or [CHAR] to move the cursor forward one character
- [LINE] ([SHIFT] + [EOL]) to move the cursor to the beginning of the line
- [EOL] to move the cursor to the end of the line
- [ALT] + [→] to move the cursor to the beginning of the next line without executing the current command line
- [DEL>] to delete the character under the cursor
- [←DEL] to delete the previous character
- [ALT] + [DEL>] to delete from the cursor to the end of the line
- [ALT] + [←DEL] to delete from the start of the line to the cursor
- [RELAY] to retype the line up to the current position of the cursor
- [COPY] or [PASTE] to copy the previous command line into the current line at the cursor position

When the cursor is not at the end of the current line, typing a character causes that character to be inserted at the position of the cursor. The cursor and the characters to its right are moved one character to the right.

Using the [COPY] key together with the other editing keys can avoid much re-typing if you want to execute a series of similar commands.

2.7 Editing text files

If the file you propose to edit is less than 20k long, we suggest you use the supplied BASIC text editor, RPED. This displays a constantly updated version of your file on the screen and allows you to use the cursor keys etc to move around the file and edit it.

Providing your system uses the provided PROFILE.SUB, just type RPED after a system prompt and then follow the instructions that appear on the screen. Otherwise, you will need to put Side 2 of the system discs in the drive.

The alternative is to use the CP/M text editor ED. This utility is on Side 3 of the system discs. It will store the changed file under any name and on any disc you choose – provided, of course that there is room for it.

ED has its own set of commands for inserting new material, deleting old material and so on. These are outlined below. Do not expect the cursor keys and the two DEL keys to have their usual effect.

Preparing to edit The first thing that ED will want to know is the file it is to edit (the Source File) and the file in which the edited version is to be stored (the Destination File).

The most general form of the instruction to open the edit is:

```
ED source destination
```

where *source* represents the name of the file to be edited and *destination* the name of the file that will hold the edited version.

For example:

```
ED OLDFILE.TXT NEWFILE.TXT
```

takes OLDFILE.TXT as the source and stores the edited version as NEWFILE.TXT.

Often you simply want to replace the old version with the edited version. In this case, the names of the source and destination files will be identical and so the instruction to edit the file can be shortened to:

```
ED file
```

where *file* represents the name of the file to be updated.

For example:

```
ED MYFILE.DOC
```

will update a file on the default drive called MYFILE.DOC.

ED M:TEMP.\$\$\$

will update a file on the memory disc called TEMP.\$\$\$.

Except where the edited file is going to directly replace the source file, the ED command will fail if a file already exists with the same file specification.

Once you have typed in the appropriate edit instruction and provided there are no problems, ED will show that it is ready to start editing the file by displaying on the screen:

: *

The asterisk is the ED prompt and shows that it is ready to accept further commands.

Starting the edit ED uses an area of memory as its workspace and before you can edit a file, you have to put it into this workspace. The workspace is big enough to hold most reasonably sized files, but sometimes the file to be edited is bigger than the workspace. Such a file will have to be edited in sections.

The next thing to do is therefore to put a suitable number of lines of data from the source file into ED's workspace. For this, you need ED's Append command, which has the form *nA* where *n* is the number of lines you want transferred.

Having to specify the number of lines you want to edit may well seem an unreasonable demand, although with practice you might find this useful because it means you can edit the source file a bit at a time.

Fortunately, ED has two shorthand versions of the command: one (*#A*) to load as much material as possible from the source file into its workspace and the other (*ØA*) to half fill the buffer. *ØA* is particularly useful because this will ensure that there is plenty of room for the file to grow as you edit it.

Editing large files If not all of the file will fit in the memory buffer, you will have to edit it in sections.

Use *ØA* to half fill the buffer, leaving room for new material, and edit this part of the file completely. Then move on to the next section.

The way you move on to the next part is by first writing some or all of the buffer to the destination file by using ED's Write command. The instruction here is either *W* to write everything to the destination file or *nW* to write just *n* lines.

This done, use the Append command to read more lines into the buffer from the source file and continue editing.

Repeat this process until the whole file has been edited.

The editing commands ED's commands are essentially concerned with inserting or deleting material at the current position of an imaginary pointer within the memory buffer. They also cover moving the position of the pointer, searching for particular phrases, replacing these with other text and displaying the result of these actions.

Details of the commands you are likely to want are given below. More information about the ED commands may be found in chapter 5.

Moving the pointer You will often want to move the pointer forwards and backwards on the same line or to a different line. These actions are controlled by the C and L commands, *n*C moving the pointer *n* characters forward (backwards if *n* is negative) and *n*L moving it to the beginning of the line *n* lines forward (backwards if *n* is negative).

For example, if you want to move the pointer back 10 characters, the instruction would be -10C, while the one to move the pointer forwards three lines would be 3L. If you just want to move one character or line, you would just type C or -C, L or -L.

To move the pointer to the beginning of the line, type 0L.

Should you want to move the pointer to the beginning or the end of the text you are editing, the instruction to use is B to put it at the beginning or -B to put it at the end.

Displaying what you are editing ED doesn't automatically show you what it is editing or the result of the edit. To see this, you have to use ED's Type command.

The basic command is *n*T: this tells ED to display on the screen the *n* lines after the pointer (*n* lines before the pointer, if *n* is negative).

If all you want to see is what is between the current position of the pointer and the end of the line, type T. To display a whole line, you have to move the pointer back to the beginning of the line before typing T. Type #T to see everything between the current pointer position and the end of the text you are editing.

Inserting characters The command to start inserting characters is i. If you want everything to be inserted in upper case characters, type I.

Everything you type after the i or I will be inserted wherever the pointer is. ED will not start a new line until you press the Return key.

The code to leave this insert mode is 'Control-Z'. So press [ALT] + Z or [^] to move on to another command.

Deleting characters Deleting characters either side of the pointer uses the D command. *n*D deletes the *n* characters after the pointer (before it if *n* is negative).

For example, to delete the six characters before the pointer, type -6D.

Type just D or -D if you just want to delete one character.

If you want to delete a whole block of text, you should use the Kill command. If *n* is positive, typing *n*K deletes everything up to the beginning the *n*th line after the current line. So if you are on Line 3 and you type 6K, ED will delete everything up to the beginning of the old Line 9, which is then appended to Line 3.

If *n* is negative, ED will delete the specified number of whole lines plus all the characters in the current line to the left of the pointer. So if, for example, you are on Line 9 and you type -6K, ED will delete everything back to the beginning of Line 3. Any characters left on the old Line 9 form the new Line 3.

As you might imagine, it is very easy to delete more than you intended with the Kill command. So until you become really familiar with how it works, always move the pointer to the beginning of the line first.

If you want to join two lines together, use the L command to move the pointer to the beginning of the second line and then type -2D.

Search and Replace ED has a Substitute command to search through the buffer from the current pointer position and to replace a given string of characters when it finds it with a new string.

The most general form of the S command is:

```
nSearch-string'Control-Z'new-string'Control-Z'
```

This replaces the next *n* instances of *search-string* with *new-string*, starting from the current position of the pointer. If *n* is omitted, the action is carried out just once.

The pointer is left at the end of the last newly substituted string.

ED doesn't allow more than 100 characters in any one command, so keep your chosen strings reasonably short. If necessary, split your search and replace job into two or more similar operations.

Finishing the edit Most of the time, all you will need to type to finish your edit is E - typed in after one of ED's asterisk prompt symbols.

Alternatively, you may decide to abandon the edit altogether. This is done by typing in Q after the asterisk.

ED error messages All the error messages generated by ED have the same form:

```
BREAK "symbol" AT letter
```

The symbol identifies the type of failure that has occurred, while the letter identifies the type of editing process in which the failure happened – S for Substitute, W for Write, and so on. Full details are given in chapter 5.

Any other messages you see will be CP/M error messages. These are explained in Appendix IV.

2.8 Erasing files

You delete files you no longer need by using an ERASE command. The space taken up on the disc by the data and the entry in the directory are automatically reclaimed for use by a later file.

The most general form of this command is:

```
ERASE file or ERA file
```

where *file* represents the name of the file to be erased.

For example:

```
ERA MYFILE.COM
```

erases the file on the default drive called MYFILE.COM

```
ERASE M:TEMP.TXT
```

erases the file on the memory disc called TEMP.TXT

If no file is found with exactly the given name, the screen message No File will appear.

The ERASE command also allows you to use Wildcards to reduce the number of instructions needed to erase a number of files.

The characters that can be used as wildcards are * and ?

An asterisk is used to represent any valid group of characters. It can replace a whole filename or filetype or it can complete a filename or filetype when you quote the character(s) that start it.

A questionmark can only represent any single character or blank in the same position as itself.

Needless to say, the wildcard version of the ERASE command needs to be used with care. Under CP/M, a file erased in error cannot be restored.

A way of guarding against this while still taking advantage of the compact wildcard instruction is to use the Confirm Option of the ERASE command. The usual command is followed by [C] or [CONFIRM]

As CP/M finds entries in the disc's directory that match the given specification, it displays the filename, along with a message asking you to confirm whether this file is to be deleted. It then proceeds to find the next match.

For example:

ERA *.DAT [C]

finds all the files on the default drive that have the filetype DAT and asks you to confirm that you want each one erased.

Notice the single space before the [C]

2.9 Finding the size of a file

If you want to know the size in kilobytes of one or more files, the command to use is the DIR command with its SIZE option. CP/M recognises that you want this additional information if you add [SIZE] to the end of your DIR command.

You get this information only for the files you want, either by going through one by one giving the full name of each file you want or by making appropriate use of Wildcards.

The characters that can be used as wildcards are * and ?

An asterisk is used to represent any valid group of characters. It can replace a whole filename or filetype or it can complete a filename or filetype when you quote the character(s) that start it.

A question mark can only represent a single character or blank in the same position as itself.

For example:

```
DIR PR???.* [SIZE]
```

displays the names and sizes of all those files with at most five letter filenames starting with PR

2.10 Formatting discs

Formatting is the preparation a blank disc needs before data can be stored on it.

If you also want to be able to load CP/M from the new disc, it is easiest to copy a suitable disc (see section 2.2). Formatting is automatically a part of the copying process. You can then use the ERASE command to erase all but CPM3.EMS from the newly copied disc (see section 2.8).

Simply to format a new disc involves using the DISCKIT utility.

You can format an old disc but you should remember that this will destroy all the old data.

Start by checking that the Write Protect Holes of your system discs are open so that you cannot accidentally format these discs. (There is a diagram showing the position of the Write Protect Holes and how they open and close in chapter 2 of the PCW8256 User Guide.)

Ensure that Side 2 of the system discs is in Drive A or that the DISCKIT utility has been copied into the memory disc.

Type DISCKIT. This brings up the first set of messages, which offer the choice of Copy, Format or Verify (or Exit from DISCKIT), and tell you which key to press to select the required option. In this instance, the Format option is required and so the [*f*] key should be pressed.

Users with just one disc drive will then get a message asking them to remove the system disc and replace it with the disc to be formatted. Those with two drives at their disposal will be asked which drive will be used for formatting, and then asked to type Y to confirm that this information has been entered correctly.

Place the new disc in the specified drive with the side to be formatted to the left.

Throughout the formatting process, messages can appear at the top of the screen. Most of these should be self explanatory: for instance, no disc in the drive could lead to the screen message:

```
Insert disc to format
Press any key to continue
```

The messages that indicate that some error has occurred should also be self explanatory, but if you need extra help turn to chapter 5 where the DISCKIT messages are given in full.

2.11 Listing the directory

The command normally used to display information about your files is DIR. This is a built-in command: in some circumstances, it is supported by the DIR utility.

If you simply want a list of the files on a disc, type:

```
DIR drive:
```

where *drive* is the letter representing the drive holding the disc and is omitted in the case of the default disc.

For example:

```
DIR  
    lists out all the files on the default disc  
DIR M:  
    list outs all the files in the memory disc
```

If there are also some special files called System Files on that disc, you will be told this once all the Non-system files have been listed.

System files are not covered in this manual except to say that the command needed to list these files is the DIRSYS command.

A detailed discussion of the DIRSYS command is inappropriate here. All you need to remember about DIRSYS is that it works very much like DIR, but only DIR can be enhanced through the various directory searching options.

You can also use the DIR command if you just want to see if a particular file is on a disc you are working with. The command line to type is:

```
DIR file
```

where *file* represents the name of the file.

For example:

```
DIR M:MYPROG.COM  
    tests if there is a copy of the file MYPROG.COM on the memory disc
```

If there isn't, then No File will appear on the screen.

You can use this version of the command, but with wildcards, to list out details of a group of files.

The characters that can be used as wildcards are * and ?

An asterisk is used to represent any valid group of characters. It can replace a whole filename or filetype or it can complete a filename or filetype when you quote the character(s) that start it.

A questionmark can only represent a single character or blank in the same position as itself.

For example:

```
DIR M:*.COM
```

lists out just those files on the memory disc that have the filetype COM

```
DIR PR???.*
```

lists out only those files on the default disc with filenames that start PR and have no more than five characters

You can obtain more information about the files by using the Options associated with the DIR command.

To use these options, you must have the DIR utility on a disc in a logged-in drive.

Some of the more useful options are EXCLUDE, FULL and SIZE. EXCLUDE enables you to list all files **except** those with the given filename; FULL makes the directory listing include size and all the special characteristics along with the name of each file; and SIZE gives the size of each file listed.

The SIZE option is used most often to discover how big a particular file is, typically just before it is copied from one disc to another.

For example:

```
DIR M:MYPROG.COM [SIZE]
```

displays the filename, filetype and size in kilobytes of a file on the memory disc called MYPROG.COM

Notice the single space before the first square bracket.

2.12 Listing a file

If you want to examine the contents of any file on the screen, type:

```
TYPE file
```

where *file* represents the name of the file to be listed.

The contents of the file are displayed on your monitor, a screenful at a time. Press the space bar to see more.

If you would like to get a print out of the file at the same time, type 'Control-P' ([ALT] + P) before you type the above command. The PCW8256 will bleep when you do this. Now all the text that appears on the screen will be 'echoed' on the printer.

A second 'Control-P' will turn the printer off.

Alternatives to both of these instructions are provided by the PIP utility.

```
PIP CON:=file  
copies the named file to the screen
```

```
PIP LST:=file  
copies the named file to the printer
```

2.13 Operating the printer

When you turn your PCW8256 on, its printer is set up to print on A4 paper. This will give you up to 61 lines of text, the first line on each page being an inch down from the top and the last half an inch from the bottom.

That will probably suit most of your purposes very well but occasionally you may want the printer to handle a different sort of paper. If you are to continue to use the printer efficiently, you must set the printer up for this new paper. Some application software will do this for you but not all.

You will also want to load paper into the printer and release the paper after the current job is completed. We describe all of these actions below.

Auto-loading the printer

The printer is set up so that paper resting in the paper guide will be automatically fed into the printer and left so that printing will begin in the correct position.

The actions you have to take are very simple.

First place the paper you wish to use centrally in the paper guide so that its top edge rests against the printer. If you plan to use continuous stationery, you should have the additional tractor feed mechanism fixed to the top of the printer.

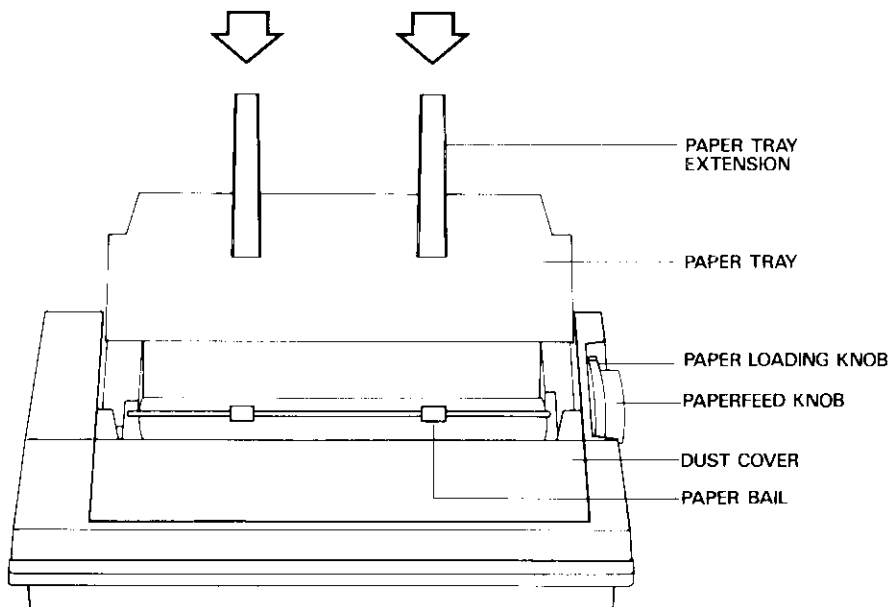

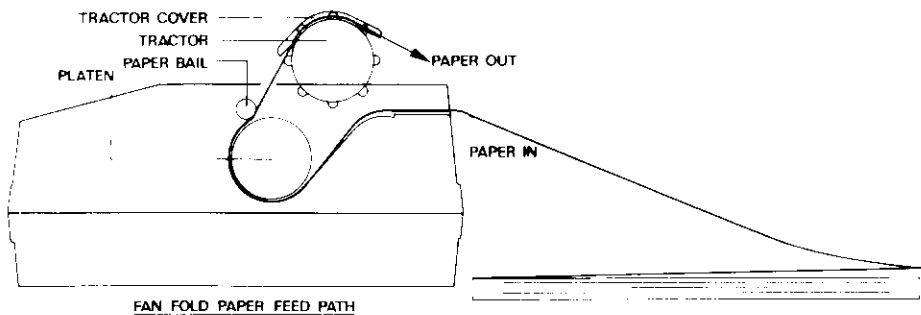

Next turn the Paper Loading Knob one quarter of a turn towards you. This also moves the bail bar forward.

The printer itself now feeds the paper in. If the paper is slightly crooked, do not adjust it yet. Turn the knob back to its original position, and only then adjust the paper if this is necessary.

A single sheet of paper will now be in the right position for starting printing.

If you are using continuous paper, you will now have to move the paper through further using the Paper Feed Knob until you can engage the paper holes in the tractor feed clips.

Then turn the Paper Feed Knob until the print position is approximately $\frac{1}{8}$ inch below the next line of perforations. This is its Top of Form position.

You should now be ready to start printing, but before you press `[EXIT]`, check that the printer is set up for the paper you are using. This is described below in 'Changing the paper settings'.

Other printer operations

Further printer operations become possible when the PCW8256 is put into its Printer Control State. These include:

- making the printer ready to print (putting it On-line)
- putting the printer on stand-by (Off-line)
- changing the quality of the printing from the usual Draft quality to one suitable for business letters (High Quality)
- and releasing the last sheet printed on.

These are the sort of operations that are often done on other printers by pressing buttons on the printer itself.

The PCW8256 enters Printer Control State either when you press the [PPR] key or when you operate the Paper Load Knob on the printer. The PCW8256 also puts itself into Printer Control State if you try to print something while it is waiting for paper.

If the printer is in the middle of printing out some text when you press the [PPR] key, it will halt as soon as it has finished either printing the current line or moving the paper to the next print position.

The operations that can be carried out in this state are now indicated on the bottom line of your screen. This line also gives you information about the state of the printer.

Scanning from left to right, you will see that the line is divided into either seven or eight separate parts by vertical bars. The first of these is highlighted, indicating that the cursor is on this one.

Each section is effectively a 'button' which you press by moving the cursor to that button and pressing either the [-] or the [] key. The set of buttons you get depends on the state the printer is in.

The first button displays the current state of the printer. This will tell you, for example, if the printer is On-line (temporarily halted), Off-line (permanently halted), Waiting for paper or the Bail bar is out.

You must be On-Line for the printer to print. Change from Off-line to On-line (by pressing [-]) or from On-line to Off-line (by pressing []).

If the printer is either On-line or Off-line, the next message will be either at Line: *n* or Top of Form . This gives the current position of the paper as a number of lines of text (*n*) printed with a line spacing of 1/6in. If the message is Top of Form , this means Line 1 on continuous stationery but Line 7 on single sheet stationery.

The next two buttons are usually LF (for Line Feed) and FF (for Form Feed). Move the cursor to one of these buttons and press [+] to get these actions. One Form Feed will release the current sheet of paper.

The next four buttons allow you to choose to print in Draft quality or High quality, to override the automatic system that detects the end of a sheet of paper, to have everything printed as the equivalent hexadecimal number and to reset the printer.

The one you are most likely to use is the Draft Quality/High Quality button, because this gives you the option of producing professional style letters and documents. Pressing either the [-] or the [] key will swop the printer between these two print styles.

The effects the other buttons have are described in Appendix II, along with fuller details of all the printer control operations.

When you are happy with the printer settings, just press [EXIT] and continue with whatever you want to do.

Changing the paper settings

Changing the paper settings on the PCW8256 involves the PAPER utility. This is on Side 2 of your system discs.

A PAPER command includes one or more parameters that describe the paper you want to use. Some of these parameters are used to make small adjustments to the way print appears on the page; others set a whole new standard format. It is the ones that set standard formats that you are most likely to use.

For example, the PAPER command to use when you change from using A4 paper to A5 paper is:

```
PAPER A5
```

Another common change you are likely to make is from A4 to continuous stationery, the commonest form of which has perforations every 11 inches. The command to use here is:

```
PAPER 11
```

In either case you would change back by typing:

```
PAPER A4
```

As these commands are executed, various messages will appear on the screen. These in fact tell you all the setting changes that are made, not that you should need to worry about these.

If you need to change the paper parameters in any other way, turn to chapter 5 where full details of the PAPER utility are given.

Troubleshooting the printer

If anything strange seems to be happening when you are printing, put the PCW8256 into Printer Control State by pressing [PTR] unless the computer has already done this for you. This automatically halts the printer: it also lets you see precisely what the printer is doing.

To show what to do next, we have tabulated some common printer problems.

- Printer does not respond: Printer Control message says Off Line

With the cursor on this message, press [i]. Then press [EXIT] to return to printing.

-
- Printer does not respond: Printer Control message says Bail bar out

Turn the Paper Load Knob away from you to return the bail bar to its normal position. Then press [EXIT] to return to printing.

- Printer does not print: Printer Control message says Waiting for paper

Check first that paper is loaded into the printer. If it is, check the cursor is on this message and then press []. Finally press [EXIT] to return to printing.

It is possible that you are using continuous stationery but the printer is set up for single sheets of paper. Check this at your earliest opportunity, changing the settings as required with the aid of the PAPER utility.

- Printer does not print: Printer Control message says Out of paper

Check first that paper is loaded into the printer. If it is, move the cursor to PO DEFEAT and then press []. Finally press [EXIT] to return to printing.

- Printer does not respond: Printer Control message says No printer

This says that the printer is either not connected or is faulty.

First check that both the power and ribbon cables that go between the printer and the PCW8256 system unit are connected properly. Then move the cursor to the RESET button and press [].

If the No printer message does not go away, then either your printer or your PCW8256 could be faulty.

Press [EXIT] to go back to whatever you were doing.

2.14 Personalising your system

There are a number of features of both the PCW8256 and CP/M that you can set up to make your applications programs easier to run. You can:

- Put sequences of commands you use often into special files. Then you will need just one command to get CP/M to carry out the whole sequence.
- Make certain actions happen automatically when you load CP/M. For example, copying the utilities from the system disc to the memory disc.
- Make the function keys generate special characters or whole commands.

Generating command sequences

The first of these options involves the use of the SUBMIT utility.

Suppose, for example, that you often follow the loading of CP/M by copying all the COM files on the disc in Drive A into the memory disc and then set the disc search order to M: followed by the default disc (see section 2.17). The commands that you usually type would be:

```
PIP M:=A:*.COM  
SETDEF M:,*
```

If you were to put these into a file, which you called TRANS.SUB and stored on Side 2 of your system discs, you could then just type:

```
SUBMIT TRANS
```

to get the same effect.

Extending what happens when you load CP/M

If you want to make copying the utilities into the memory disc and setting the program search order an automatic part of loading CP/M, you should just put these instructions in a special file called PROFILE.SUB instead of storing these instructions in TRANS.SUB.

Any commands in PROFILE.SUB are always executed as part of loading CP/M. You never need to type SUBMIT PROFILE

Making use of the function keys

To make the function keys generate special characters or whole commands, you will need the SETKEYS utility.

Suppose, for example, that you would like to run your spreadsheet program (which we will call MYSREAD.COM) by pressing [f_1], instead of typing MYSREAD [RETURN]

To make this happen, you will need a file (which we will call FNKEYS) holding the line:

```
E #81 "MYSREAD ↑M"
```

The #81 is the code that represents the [f_1] key. The other function keys, [f_2] to [f_8], have the codes #82 to #88. These may be set up through similar lines in the FNKEYS file. The ↑M represents 'Control-M', which is the control code equivalent to pressing the Return key.

Then you will have to type the command:

```
SETKEYS FNKEYS
```

Thereafter, pressing [f_1] will command CP/M to run your MYSREAD program.

This SETKEYS command is another worth putting in your PROFILE.SUB file.

A more complete description of the SETKEYS utility is given in Appendix I. It should, however, be pointed out that while the commands themselves are easy to use, it is also easy to re-define your keyboard so that it is impossible to use. You should therefore always plan and check over any changes very carefully.

2.15 Renaming files

The renaming of files is handled by the built-in RENAME command, in some cases supported by the RENAME utility.

Renaming is just a change of name: the data or program file itself is not altered in any way by RENAME.

The most general form of the command is:

```
RENAME new name=old-name or REN new-name=old-name
```

where *old-name* represents the current name of the file and *new-name* the name you wish to change it to.

For example:

```
REN DOC.BAK=DOC.TXT
```

changes the name of the file DOC.TXT on the default disc to DOC.BAK

```
REN M:RECORDS.Y85=M:RECORDS.LST
```

changes the name of the file RECORDS.LST on the memory disc to RECORDS.Y85

The only restriction on your choice of *new name* is that it must not be the name of any existing file on that disc.

The command will fail if you quote a different drive for the file under its old name to that you quote with its new name.

If CP/M fails to find *old name* in the directory, the message No File will be displayed on the screen.

You can reduce the number of instructions needed to rename a number of files by appropriate use of wildcards.

The characters that can be used as wildcards are * and ?

An asterisk is used to represent any valid group of characters. It can replace a whole filename or filetype or it can complete a filename or filetype when you quote the character(s) that start it.

A question mark can only represent a single character or blank in the same position as itself.

But if you do decide to use the wildcard option, you must remember to make the wildcards in *old name* and *new name* identical. For example, REN *.TX1=*.TEX and REN A*.T*=S*.T* are valid commands but REN A*.TEX=A*.T* isn't.

2.16 Resetting the PCW8256

Resetting the PCW8256 returns it to the state it was in just after you switched on.

Remove all discs from the disc drives: then hold down the **[SHIFT]** and **[EXTRA]** keys before pressing the **[EXIT]** key. This clears the PCW8256's memory, including the memory disc.

Then insert your Start of Day disc (see section 2.5) and press the space bar, just as if you had just turned the machine on.

You will see the familiar pattern of horizontal lines appear, followed one by one by command lines from PROFILE.SUB, if this exists.

When the PCW8256 is ready, an A> system prompt will appear on the screen on a fresh line.

2.17 Shortening the command line

You can shorten many of your command lines by extending the way CP/M interprets the commands you give it.

The utility which redefines how CP/M handles your commands is called SETDEF. It has two principal actions: extending the number of drives automatically searched for utilities; and instructing CP/M to treat SUBMIT files as additional utilities.

Searching additional discs

If you just load CP/M, any utility you use such as PIP is assumed to be the filename of a .COM file on the default drive.

To change this, you use the SETDEF utility with the drives you want searched as its parameters. The order in which you list the drives will be the order in which they are searched for utilities.

An asterisk is used to represent the default drive. **It is not followed by a colon.** This use of an asterisk is special to SETDEF.

For example:

```
SETDEF M:,A:
```

instructs CP/M to look for utilities first on Drive M and then on Drive A

```
SETDEF M:,*
```

instructs CP/M to look for utilities first on Drive M and then on the default drive.

This second command line is included in the PROFILE.SUB file we suggested you set up in chapter 1.

Including SUBMIT files in the search

The ORDER option of the SETDEF utility is used to extend the search to cover SUBMIT files you set up.

You can either specify that CP/M searches .SUB files first and then .COM files or vice versa. It executes the first file it finds with the given name.

The two possible SETDEF commands are:

```
SETDEF [ORDER=(SUB,COM)]
```

and

```
SETDEF [ORDER=(COM,SUB)]
```

Notice the single space before the first square bracket.

The first of these is your more probable choice as the SUB file you have set up is likely to carry out more actions than the .COM file of the same name.

Suppose you had made this choice. Then, the command line:

```
MYCOMM
```

would make CP/M search first for a file called MYCOMM.SUB and only if it cannot find it, would it carry on and search for a file called MYCOMM.COM.

If it finds MYCOMM.SUB, CP/M will execute the command as if you had typed:

```
SUBMIT MYCOMM
```

2.18 Switching which disc is read or written

You switch discs either by changing which drive is treated as the default drive or by physically changing the disc in a drive.

The default drive is changed by simply typing in *new drive*:

For example, suppose you would like the memory disc to become your default drive. The command to type in is just:

M:

Most of the time when you want to change which disc is in Drive A or Drive B, all you need to do is release the old disc and put in the new one.

But there are some circumstances in which the data on the new disc could be damaged if you don't tell CP/M that you have changed the disc in the drive immediately after putting the new disc in. Always resetting the drive is therefore a good habit to get into.

The drive is reset by the control code, 'Control-C', which is generated either by pressing `[ALT] + C` or by pressing the `[STOP]` key.

Commercial software for the PCW8256

The advantage of running CP/M Plus on the PCW8256 is that you can then run a number of programs bought 'off the shelf' from your computer dealer. These could be computer games, accountants' spreadsheets or project planners.

Unfortunately, although CP/M software will run on the PCW8256, it won't always produce the results you expect. It may not control the screen or the printer properly, or it may not respond correctly to the keyboard.

If it is to work correctly, it will usually have to be 'installed' on the PCW8256.

This chapter provides a guide to avoiding the pitfalls and generally getting the best out of CP/M programs you buy. It will be useful to have this chapter handy when you buy software from an independent software dealer so that the dealer can check whether the software will work properly on the PCW8256.

3.1 Suitable software

Software for the PCW8256 must be:

- Written to run under the CP/M 2.2 or CP/M Plus (CP/M 3) operating systems

And:

- Supplied on a 3inch Compact Floppy disc in either Amstrad CPC664/CPC6128 or Amstrad PCW8256 format

It is also advisable to choose, if possible, software that has been installed to run on the PCW8256.

Your dealer will be able to tell you whether a suitable version of the software you want to use does exist. If the software is available in the right format but has not been installed on the PCW8256, you (or your dealer) will need to modify the program so that it will work correctly on your machine. This is a straightforward task but it may require detailed background knowledge.

If the program was written specifically for another computer, it may not be possible to modify it without specialised help. Check with your dealer that this is not the case!

The process of modifying the program is called installing and it is covered in section 3.4 of this chapter.

3.2 First steps

Whether your software is ready to run on the PCW8256 or whether it has to be installed first, it is wise to start by making a copy of the software discs you have just bought. That way you can keep the originals as the Master Copy, safely stored away in case of accidents.

A good move before you get involved in copying is to open the Write Protect Holes on your system disc and the discs you intend to copy so that you cannot spoil them by accidentally writing to them. So do this before you go any further.

There is a diagram showing the position of the Write Protect Holes and how they open and close in chapter 2 of the User Guide.

The way to make your working copy is to format as many new blank discs as you will require using the DISCKIT utility (see section 2.10) and then copy the files on the Master discs one by one using the PIP utility (see section 2.3).

You are now ready to go on either to run the software or to install it.

3.3 Running ready installed software

The next step is to organise your working discs to make the software easy to use. You can do this in two ways:

Either:

Create and use a Start of Day disc from which you load CP/M and any utilities you expect to need. Once you have loaded CP/M, you replace this disc with the one holding the copy of the software

Or:

Use PIP to add CP/M and the utilities from your Start of Day disc to the disc holding the copy of the software

The second of these options is only possible if all these programs can fit on the same side of the disc.

Another thing to pay attention to is where you are going to store any data that the program generates. You can either plan to store this on the same disc as the program (if there is

enough room) or use a special disc just for data. If you take the second option, either use a disc that has already been formatted or format a new blank disc using DISCKIT.

You can now run the software by loading CP/M and then running your program, following the instructions in the program's own instruction manual/user guide. The final piece of advice is to keep duplicate copies of all your important data files: the quick and simple way of doing this is to copy the whole disc, using DISCKIT.

3.3.1 Turnkey operation

If you take the second option for organising your discs, you can additionally use the PROFILE.SUB file to load the application software immediately after CP/M.

The precise details will depend on the software you want to run in this way, but essentially, what you have to do is edit PROFILE.SUB so that it ends with the command line you would normally type to run the application. This is described in section 2.14: 'Personalising your system'.

Using such a disc is known as Turnkey Operation because you just turn the computer on and the software runs. It is particularly useful if you want other people, who may not understand CP/M, to use the software you have bought. You can then just tell them to turn the PCW8256 on, put in the disc, press the Space bar and follow the instructions both on the screen and in the program's own instruction manual/user guide.

3.4 Installing the software

This section advises you on how to go about installing software. If your software comes ready installed, this section should be ignored.

The first thing to find out is whether the application you would like to install on your PCW8256 was written specifically for another computer or for a range of computers. If it was written specifically for another computer, you will probably need specialised help.

If it was written for a range of computers, there will be a program (either with the software or as a special part of it) that is designed to help you install the application. The job of this installation program is to set parameters within the main program according to information you supply about how the PCW8256 works.

The relevant information about the PCW8256 is tabulated at the end of this chapter. However, the form in which the details will be requested varies from software package to software package, and so there is no guarantee that you will be able to use this information directly.

If you are lucky, how the installation program works will be explained in the documentation supplied with the software.

Your best source of advice is your dealer who will know both the PCW8256 and the software you propose to install.

3.4.1 Running the installation program

The installation program will usually request information from you through a sequence of questions on the screen.

Software suppliers typically include a fairly detailed set of instructions with any software package that needs installing, and we strongly advise you to read this.

The questions that appear on the screen mainly refer to the codes generated by keystrokes at the keyboard, the codes required by the screen in order to move the cursor around or display information, and the form in which data needs to be presented to the printer. Many of these codes have been standardised over the years: it is just the ones that can vary from machine to machine that need to be specified.

The installation program is likely to start by asking you what kind of monitor and what kind of printer you have. It may well do this by offering you a list of possibilities.

If Zenith Z19/Z29 is on its list of monitors and/or Epson FX-80 or Seikosha SP-800 are on its list of printers, select these. The PCW8256's screen and printer are sufficiently like these to allow most programs to run properly.

Other programs may require you to specify the parameters more precisely. You will need to draw the answers to specific questions one by one from the tables on the following pages.

However, an option you can take in matching the keyboard to the program is to use the SETKEYS utility to redefine the codes the keyboard produces. The way to do this is described in Appendix I.

This can be simpler than giving the installation program details of the codes produced at present, particularly when your software is one of many to use a certain set of codes. For instance, a number of programs use a similar set to some word processing packages. We have put a key definition file, KEYS.WP, on Side 2 of the system discs that can be used with the SETKEYS utility to set the PCW8256 up to suit these programs.

The installation program of the software package should only ever need to be run once. The program ensures that the special parameters are set to the right values throughout the software package. However, if you do use SETKEYS, this has to be run each time.

3.5 PCW8256 parameters

Keyboard operations

	Hex value	Decimal value	Key number
Cursor up	# 1F	31	14
Cursor down	# 1E	30	79
Cursor right	# 06	6	6
Cursor left	# 01	1	15
Delete character under cursor	# 07	7	16
Delete last character	# 7F	127	72
Escape (Exit)	# 1B	27	8
Return	# 0D	13	18
Space	# 20	32	47
Tab	# 09	9	68

Further details of the keyboard control codes are given in Appendix I

Printer operations

	Hex value	Decimal value
Backspace	# 08	8
Carriage return	# 0D	13
Line feed	# 0A	10
Form feed	# 0C	12
Set bold	# 1B # 45	27 69
Cancel bold	# 1B # 46	27 70
Set underline	# 1B # 2D # 01	27 45 1
Cancel underline	# 1B # 2D # 00	27 45 0
Set superscript	# 1B # 53 # 00	27 83 0
Cancel superscript	# 1B # 54	27 84
Set subscript	# 1B # 53 # 01	27 83 1
Cancel subscript	# 1B # 54	27 84

Further details of the printer control codes are given in Appendix II

Screen operations

	Hex value	Decimal value
Sound bleeper (Bell)	#07	7
Move cursor back one space	#1B #44	27 68
Move cursor forward one position	#1B #43	27 67
Move cursor down one line	#1B #42	27 66
Move cursor up one line	#1B #41	27 65
Carriage return	#0D	13
Line feed	#0A	10
Delete character under the cursor	#1B #43	27 78
Delete character to left of cursor	#08	8
Clear the screen	#1B #45	27 69
Clear all the screen up to the cursor	#1B #64	27 100
Clear all the screen after the cursor	#1B #4A	27 74
Clear the line to left of cursor	#1B #6F	27 111
Clear the line to right of cursor	#1B #4B	27 75
Move the cursor to Home position	#1B #48	27 72
Move cursor to left hand edge of screen	#0D	13
Move cursor to row <i>r</i> , column <i>c</i>	#1B #59 <i>r c</i>	27 89 <i>r c</i>
(<i>r</i> and <i>c</i> are actual values plus #20 (hex), 32 (decimal))		
Insert a line	#1B #4C	27 76
Delete a line	#1B #4D	27 77
Enter inverse video	#1B #70	27 112
Leave inverse video	#1B #71	27 113
Enter underline mode	#1B #72	27 114
Leave underline mode	#1B #75	27 117

Further details of the screen control codes are given in Appendix III

Graphics on the PCW8256

One of the benefits of having the CP/M operating system on the PCW8256 is that PCW8256 users can run programs with graphical output – everything from simple data plots to quite complex pictures – through the Graphics System Extension to CP/M.

GSX, as this additional system software is called, converts all the graphics instructions produced by a CP/M program into instructions understood by whatever 'Output Devices' (ie which particular monitor, printer and/or plotter) you have.

This means that you will be able to run programs that create bar charts and pie charts, even if these have been written for other CP/M computers.

GSX doesn't itself have the power to draw such pictures for you: for that you need dedicated graphics application software. The examples below were drawn using Digital Research's DR Graph program.

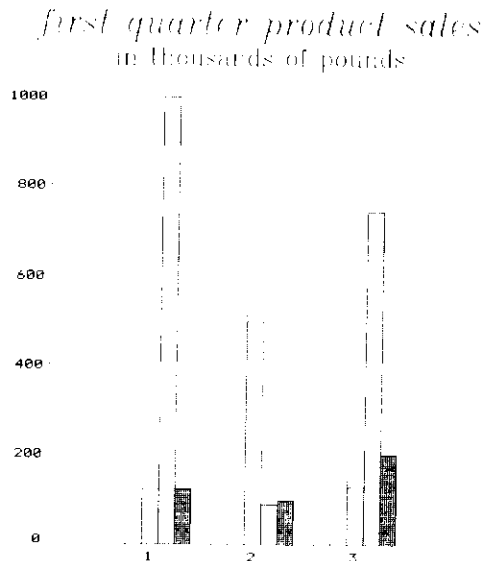
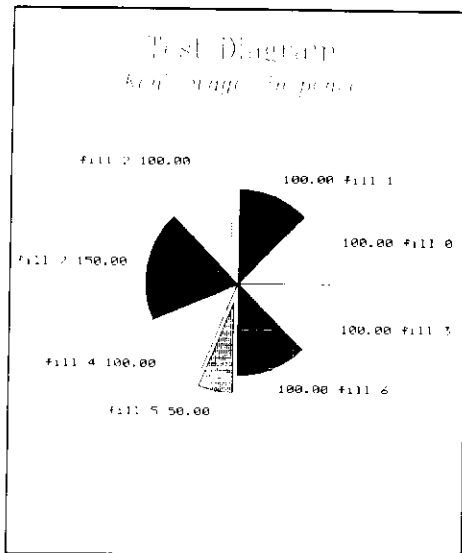

Although it is possible to generate such graphics through your own programs, you will need to know GSX's controls and calling sequences to do this. You should refer to Soft 971: 'A Guide to CP/M Plus' for these as they are outside the scope of this manual.

The chief advantage of GSX is that it is device independent. Despite all the differences in the way individual monitors, printers and plotters draw lines, fill in areas and add text to graphics, the application program shouldn't need to be altered if you choose to use a plotter rather than a printer, say.

Moreover, you will get essentially identical output on your printer as you would on your monitor, simply by telling the program to send the data to your printer.

GSX can't, of course, operate every printer or plotter that has ever been built, nor can it be used by every program producing graphical output. The software has to have been designed to run under CP/M with the GSX extension, and the data about driving the printer/plotter must exist in the right form to be interpreted by GSX. This data is supplied in special files known as Device Drivers, one for each output device.

It must also be remembered that not all output devices have the same facilities. For example, a number of monitors have no way of filling in an area outlined on the screen. In such cases, the program will still run but the full graphic effect will not be produced. For example, the outlined area will be left unfilled.

GSX is a standard understood and designed for by a number of computer manufacturers and programmers. You will therefore be able to choose from a wide variety of output devices and applications programs.

4.1 The PCW8256's GSX software

Most of the system software needed to run GSX programs on the PCW8256 is on Side 4 of the system discs. The remaining file -- DDHP7470.PRL -- is on Side 3.

This software comprises:

GSX.SYS	the file holding the GSX extension itself.
ASSIGN.SYS	the file that records what output devices you have and the Logical Device Numbers by which the program refers to them.
GENGRAF.COM	a utility that is used to ensure that GSX will be loaded automatically at the same time as the program needing it.
DDSCREEN.PRL	the device driver file containing the relevant information about the PCW8256's monitor.
DDFXLR8.PRL	the device driver file containing the relevant information about the PCW8256's printer.

DDFXHR8.PRL	an alternative device driver file which makes the PCW8256's printer print with higher resolution.
DDHP7470.PRL	The device driver file containing the information that will be needed if you add a HP Compatible pen plotter to your system.

You may add to this list as you acquire new peripherals for your PCW8256.

GSX needs these files to run on the PCW8256, so take care not to delete them.

4.2 GSX programs for the PCW8256

There are a number of commercial software packages that produce graphs and so on from data you enter. You will be able to run any of these programs provided that they have been developed to run under CP/M 2.2 or CP/M Plus (CP/M 3) with the GSX extension and that they are available on Amstrad format 3inch discs.

You can also develop your own programs to draw graphs and pictures on the PCW8256 in very much the same way as you would develop any program to run under CP/M on the machine, except that it has its own vocabulary of instructions. Details of these are beyond the scope of this introduction: you will need to refer to Amstrad's Soft 971: 'A Guide to CP/M Plus'.

Any software you buy will either already be in the correct version for running on the PCW8256, or come with an installation program to help you set the parameters needed to allow the software to run on your computer.

A bonus in installing an GSX program over installing any other CP/M program is that the device drivers already hold much of the information needed. The amount of data you have to supply is therefore much reduced.

The application's manual should provide all the information you need to run it on the PCW8256, especially if used along with chapter 3 of this manual which describes the installation of application software. If not, consult your dealer.

The discs you will use to run any graphics software won't be the original software discs but copies to which you have added the necessary GSX system files from Side 4. You should store away the originals as your Master copies.

To create these copies, first use DISCKIT to format as many blank discs as you need. Then use PIP to copy the files from the discs you have bought and to add copies of GSX.SYS, ASSIGN.SYS, GENGRAF.COM and whichever device driver files you require.

The manual with the application software will tell you how many and what types of peripherals it is designed to send its output to.

Commercial GSX software will almost certainly be set up to include an extra program, the GSX Loader, which adds the GSX extension to the operating system when loading the software into memory.

You can tell that the Loader is included if the screen immediately after you have loaded the software looks like this:

```
A>M:
M>a:graph
-----
GSX-80 1.1 01 Oct 83   Serial No 5000-1232-654321
Copyright (C) 1983
Digital Research, Inc.   All Rights Reserved
-----
```

If this screen doesn't appear, you need to add the Loader to the application.

The utility that will do this is GENGRAF, which you earlier copied onto your working discs. You run this utility with the application's filename as its parameter.

For example, suppose the application program is called APPLIC.COM. Put the disc with both GENGRAF.COM and APPLIC.COM in the drive, then type:

```
GENGRAF APPLIC
```

GENGRAF attaches the Loader permanently to the application program – so you won't need to run it again when you want to use this program.

With the GSX Loader in place, all you need to do to start running the program is to type in its filename after a system prompt. Any additional information it requires from you will be explained in the application's manual.

4.3 Using other printers and plotters

If you have a plotter that is compatible with the PCW8256, you may prefer to use this rather than the printer for the output from your GSX programs. The quality of the graphics is usually better on a plotter.

After checking with your dealer that the plotter you want to use is suitable, you should also check whether an appropriate device driver exists.

If your plotter is described as 'HP Compatible' and has a 'Serial Interface', you should be able to use the plotter driver supplied on Side 3 of the system discs – DDHP7470.PRL. All you will need as well is the Amstrad RS232C/Centronics Interface.

Alternatively, you might choose to use the higher resolution printer driver DDFXHR8.PRL because this will produce better graphics than the low resolution printer driver, though still not as good as a plotter.

Once you have the device driver you want, you need to copy this file onto your CSX disc, using the PIP utility (see section 2.3).

You will also need to modify the ASSIGN.SYS file. This is a list of the devices available to the program and the names of their device driver files.

The devices are referred to both in the application program and in the ASSIGN.SYS file by Logical Device Numbers. These are two digit numbers, monitors usually having numbers between 01 and 10, plotters between 11 and 20 and printers between 21 and 30.

The convention is that if you only have one of any type of device, then its logical device number is the lowest number in its related band. Thus, as you only have one monitor, its logical device number will be 01. The maximum number of output devices that can be referenced via the ASSIGN.SYS file at any time is five.

To see the current form of the ASSIGN.SYS file, type in TYPE ASSIGN.SYS after a system prompt. You should see:

```
21 A:DDFXLR8
01 A:DDSCREEN
```

To add a plotter to the system, you need to edit the ASSIGN.SYS file and insert the line
11 A:*plotter-driver*.

The ASSIGN.SYS file can be edited using any text editor. We suggest you use RPED.

To start the edit, type:

```
RPED
```

and follow the instructions.

The position in which you insert the new line in the ASSIGN.SYS file will depend on the size of its device driver file. CSX needs the largest file to be named first.

The SIZE option of the DIR command (see section 2.9) will establish which of the three files DDSCREEN.PRL, DDFXLR8.PRL and DDHP7470.PRL (or whatever) is the largest. Typically, the printer file will be the largest and the monitor file the smallest.

You will probably decide to insert the new line between the current two lines in the ASSIGN.SYS file.

For the application to use the plotter instead of the printer, it needs to be told to use logical device 11 instead of 21.

Many applications help you to do this (see the application's manual) but if it doesn't, go back to the ASSIGN.SYS file, delete the reference to the printer driver and change the plotter's logical device number to 21. The choice of numbers was merely according to a convention which doesn't have to be adhered to.

Further information about device drivers and the ASSIGN.SYS file may be found in Soft 971: 'A Guide to CP/M Plus'.













4.4 Errors associated with GSX programs

Message	Action
<i>d:filename.PRL</i> not found	The device driver listed in ASSIGN.SYS cannot be found on the specified drive: check that you specified the right drive and that the filenames match. If all else fails, re-copy the device driver onto your GSX disc.
<i>d:filename.PRL</i> empty	The device driver file has been found but there is no data in it. Delete the empty file and re-copy the device driver onto your GSX disc.
<i>d:filename.PRL</i> contains absolute segment	This is probably the result of a corrupted drive file. Re-copy the device driver onto your GSX disc.
<i>d:filename.PRL</i> close error	You probably changed discs while a file was open. Insert the correct disc and try again.
<i>d:filename.PRL</i> load error	You probably haven't got the largest device driver file listed first. Check and re-do.

4.5 Technical information

The following table gives details of types of the graphical output produced on the standard PCW8256 hardware.

You will only need this information if you write your own graphics programs or to help your dealer establish whether the graphics program you want to buy will work fully on your PCW8256.

	Monitor	Printer	
		Low resolution	High resolution
Device driver	DDSCREEN	DDFXLR8	DDFXHR8
Resolution	720 x 248	480 x 672	960 x 1368
Line styles	1 solid	1 solid	1 solid
	2 short dash	2 short dash	2 short dash
	3 dotted	3 dotted	3 dotted
	4 dash dot	4 dash dot	4 dash dot
	5 long dash	5 long dash	5 long dash
		6 dash dot dot	6 dash dot dot
Number of line sizes	1	12	12
Marker types	1 .	1 .	1 .
	2 +	2 +	2 +
	3 *	3 *	3 *
	4 o	4 o	4 o
	5 x	5 x	5 x
Number of text sizes	1	12	12
Text Directions	0°	90° intervals	90° intervals
Fill area	Outline area	1  or 	
		2  or 	
		3  or 	
		4  or 	
		5  or 	
		6  or 	
Generalised drawing primitive	Outline bar	Bar fill	Bar fill
Escapes	Yes - except no tablet no hardcopy	Inquire addressable character cells	
Input	No	No	No

The CP/M Plus built-in commands and utilities

The following pages contain descriptions and explanations of the CP/M Plus built-in commands and transient utility programs on the PCW8256, together with examples of their use.

The built-in commands are an integral part of the CP/M Plus operating system and are thus automatically loaded from the CP/M system disc when the PCW8256 is booted.

The utilities are held on Sides 2 and 3 of the system discs, with the exception of the HELP utility which is located on Side 4 together with the system software for supporting the GSX graphics system extension and Dr. Logo. The most commonly used utilities are all on Side 2.

The built-in commands have limited power and four of them, DIR, ERASE, RENAME and TYPE, have an associated utility of the same name to give them their full functionality. In particular, the utility is needed if any of the command's options are to be used.

The following descriptions of the commands and utilities have been grouped into four sections so that information on related instructions can be found within a few pages of each other. Within each section, the instructions are treated in alphabetical order. HELP is treated on its own in the fourth section.

The index on the following page lists the commands and utilities under their appropriate section headings, together with the location of the associated utility on disc and references to where else they are discussed.

Full details of the CP/M commands and utilities are given in the Amsoft publication Soft 971: 'A Guide to CP/M Plus'.

Some of the utilities may only be of use to experienced CP/M programmers. In those cases, the description here is intended only as a brief introduction to the utility. For information on these utilities, you should turn to Soft 971: 'A Guide to CP/M Plus' where their use is discussed in detail.

Throughout this chapter it is assumed that the system disc on which the required utility is stored is in the default drive. If this is not the case, the name of the utility should be preceded by A:, B: or M: as appropriate.

Conventions

This chapter makes great use of Metalanguage to describe the syntax of the various commands. This means that where you should put the the actual name of a file or a drive, we have put a brief description of the parameter that is required.

For example, we have put '*drive:*' where you should put 'A:', 'B:' or 'M:' (or omitted if the required drive is the default drive). '*filename*' is used as shorthand for '*drive:filename filetype*' and should be replaced by as much of the required file's file specification as is needed to specify the file.

In addition, optional parts of any instruction are surrounded by slanting square brackets: these parts may be omitted altogether, included just once or included as many times as appropriate. Attention must be paid to separating like items by single spaces or commas as specified in the instruction.

For example:

DIR [*option* [*option*]]

is used to represent any of

DIR [*option*]

DIR [*option*,*option*]

DIR [*option*,*option*,*option*]

...

or simply

DIR

Anything not printed in italic or enclosed between slanting square brackets must be typed exactly as shown.

The examples given with each command or utility should clear up any uncertainty in how any particular metalanguage instruction should be interpreted.

Another convention used here is to represent CP/M's control codes as 'Control-*character*' in line with other guides to CP/M. The codes have usually been associated with one of the special function keys (see the table in Appendix I) but they can always be accessed by pressing [ALT] + *Character*.

Disc housekeeping

DIR	Built-in + Side 2	Page 70
DIRSYS	Built-in	71
DISCKIT	Side 2	73
ERASE	Built-in + Side 2	75
GET	Side 3	76
INITDIR	Side 3	77
PIP	Side 2	78
PUT	Side 3	80
RENAME	Built-in + Side 2	82
SET	Side 2	83
SETDEF	Side 2	84
SHOW	Side 2	84
SUBMIT	Side 2	85
TYPE	Built-in + Side 2	86
USER	Built-in	86

Setting up the hardware

DATE	Side 3	87
DEVICE	Side 2	87
LANGUAGE	Side 2	89
PALETTE	Side 2	90
PAPER	Side 2	90
SETKEYS	Side 2	92
SETLST	Side 2	93
SETSIO	Side 2	94
SET24X80	Side 2	95

Advanced programming tools

DUMP	Side 3	96
ED	Side 2	97
GENCOM	Side 3	99
HEXCOM	Side 3	99
LIB	Side 3	99
LINK	Side 3	100
MAC	Side 3	100
PATCH	Side 3	100
RMAC	Side 3	100
SAVE	Side 3	101
SID	Side 3	101
XREF	Side 3	101

Help

HELP	Side 4	102
------	--------	-----

5.1 Disc housekeeping

DIR

Displays the names and associated details of non-system files accessible to the user through either the default or the specified drive.

- DIR displays the names and filetypes of all such files on the disc in the default drive.
- DIR *drive*: displays the names and filetypes of all such files on the disc in the specified drive.
- DIR *filespec* is used to check whether the required file is on a particular disc.
- DIR *filespec-including-wildcards* is used to display files on the default or specified drive with similar names and/or filetypes. * matches with any number of characters in the same part of the file specification, whereas ? has to match with a character or a space in the same position.

All the above variants may be enhanced by the use of one or more of the DIR command options.

These should be listed at the end of the command line, between square brackets and separated by commas or single spaces. A single space should separate the basic command from the bracketed options.

The options include:

- DRIVE=ALL causing search and listing of all accessed drives
- EXCLUDE giving the names of all files **except** those with the given file specification
- FULL giving name, size (both in kilobytes and number of 128byte records) and attributes of every file listed
- RO or RW causing search and listing of just read-only files or just read-write files, respectively
- SIZE giving name and size in kilobytes of every file listed
- USER=ALL causing search and listing of all files on the disc in the specified drive, whatever user number they were created under

This time the files are listed in alphabetical order of filename.

If searching the directory fails to find any file meeting the given specification, the message No File is displayed.

If system files exist matching the given specification, the message SYSTEM FILE(S) EXIST is displayed.

If the listing fills more than one screen, the system pauses when it gets to the bottom of the screen. Press the space bar to see the remainder of the listing.

Examples

```
A>DIR
A: PLOT      TX : PRIME    TX : PRINT    TEX : PROCESS MIX
```

```
A>DIR PR*.T*
A: PRINT    TEX : PRIME    TX
```

```
A>DIR PR*.T?
A: PRIME    TX
```

```
A>dir [drive=all]
```

```
Scanning Directory...
```

```
Sorting Directory...
```

```
Directory For Drive A: User 0
```

Name	Bytes	Recs	Attributes	Name	Bytes	Recs	Attributes
BASIC	COM	28k	224 Dir RW	DIR	COM	15k	114 Dir RW
DISCKIT	COM	8k	64 Dir RW	ED	COM	10k	73 Dir RW
ERASE	COM	4k	29 Dir RW	J10CPM3	EMS	39k	312 Dir RW
KEYS	MP	2k	14 Dir RW	LANGUAGE	COM	1k	8 Dir RW
PAPER	COM	2k	16 Dir RW	PIP	COM	9k	68 Dir RW
PROFILE	EMG	1k	2 Dir RW	RENAME	COM	3k	23 Dir RW
RPED	BAS	4k	29 Dir RW	RPED	SUB	1k	1 Dir RW
SET	COM	11k	81 Dir RW	SET24X80	COM	1k	8 Dir RW
SETDEF	COM	4k	32 Dir RW	SETKEYS	COM	2k	16 Dir RW
SETLST	COM	2k	16 Dir RW	SETSIO	COM	2k	16 Dir RW
SHOW	COM	9k	66 Dir RW	SUBMIT	COM	6k	42 Dir RW
TYPE	COM	3k	24 Dir RW				

```
Total Bytes = 167k Total Records = 1278 Files Found = 23
Total 1k Blocks = 167 Used/Max Dir Entries For Drive A: 26/ 64
```

```
A) █
```

This command is described in section 2.9 and 2.11 ('Finding the size of a file' and 'Listing the directory').

DIRSYS

Displays the names and associated details of all system files accessible by the user through the default or the specified drive.

DIRSYS displays the names and filetypes of all such files on the disc in the default drive.

DIRSYS *drive*: displays the names and filetypes of all system files on the disc in the specified drive.

`DIRSYS filespec` is used to check that the required file is on a particular disc.
`DIRSYS filespec-including wildcards` is used to display all system files with similar names and/or filetypes. * matches with any number of characters in the same part of the file specification, whereas ? matches only with a character or space in the same position.

If searching the directory fails to find any file meeting the given specification, the message No File is displayed.

If non-system files exist matching the given specification, then the following message is displayed NON-SYSTEM FILE(S) EXIST

If the listing fills more than one screen, the system pauses when it gets to the bottom of the screen. Press the space bar to see the remainder of the listing.

Examples

```
A>DIRSYS
A: GENCOM  CMD : HEXCOM  CMD : PATCH  OVR

A>DIRSYS *.CMD
A: GENCOM  CMD : HEXCOM  CMD
```

This command is described briefly in section 2.11 ('Listing the directory')

DISCKIT

Makes an exact copy of one disc on another, gives a disc the required format or verifies that all the data on a disc is readable by the PCW8256.

The utility is invoked by typing DISCKIT. This brings up the Main Menu.

The menus are graphical representations of the relevant part of the keyboard, labelled to show which key selects which option.

System messages about movement of discs and error messages appear in the Prompt Window at the top of the screen. The messages are intended to be self-explanatory.

The first letter of 'R-etry', 'I-gnore' or 'C-ancel' is sufficient to produce the desired effect.

Copying

Entered by selecting [*f5*] from the main menu. Note that any formatting required is carried out automatically as part of the copying process.

Single-drive systems

- a) select from menu asking for confirmation that copying is required: **Y** confirms; any other key returns to the main menu. Remove the system disc from the drive.
- b) remove and insert discs in accordance with messages in the prompt window.

Two-drive systems

- a) select from menu which drive to read from: [*f3*] to read from Drive A; [*f1*] to read from Drive B; [**EXIT**] to return to the main menu.
- b) select from menu which drive to write to: [*f3*] to write to Drive A; [*f1*] to write to Drive B; [**EXIT**] to return to the main menu.
- c) select from menu asking for confirmation that copying is required and that the source disc and the destination disc have been correctly specified: **Y** confirms; any other key returns to the main menu. Remove the system disc from the drive.
- d) insert and remove discs in accordance with messages in the prompt window.

After the completion of each copy operation, duplicating one side of one disc on one side of another disc, the user is offered the option of repeating the copy operation with either the second side of the same discs or a different source disc and a different destination disc: **Y** selects this option; any other key returns to the main menu.

Formatting

Entered by selecting [**F**] from the main menu. Note that formatting a disc on which data is stored erases that data.

Single-drive systems

- a) select from menu asking for confirmation that formatting is required: **Y** confirms; any other key returns to the main menu.
- b) insert and remove discs in accordance with messages in the prompt window.

Two-drive systems

- a) select from menu which drive will hold the disc to format: [**F**] for Drive A; [**B**] for Drive B; [**EXIT**] returns to the main menu.
- b) select from menu asking for confirmation that formatting is required and that the disc to be formatted has been correctly specified: **Y** confirms; any other key returns to the main menu.
- c) insert and remove discs in accordance with messages in the prompt window.

After the completion of each format operation, the user is offered the option of repeating the format operation with either the second side of the same disc or a different disc: **Y** selects this option; any other key returns to the main menu.

Verifying

Entered by selecting [**V**] from the main menu. The whole of one side of the disc is read track by track.

Single-drive systems

- a) select from menu asking for confirmation that verifying is required: **Y** confirms; any other key returns to the main menu.
- b) insert and remove discs in accordance with messages in the prompt window.

Two-drive systems

- a) select from menu which drive will hold the disc to verify: [**V**] for Drive A; [**B**] for Drive B; [**EXIT**] returns to the main menu.
- b) select from menu asking for confirmation that verifying is required and that the disc to be verified has been correctly specified: **Y** confirms; any other key returns to the main menu.
- c) insert and remove discs in accordance with messages in the prompt window.

If errors are found, the utility stops after each one and displays a message advising which file, if any, the error affects.

After the completion of each verify operation, the user is offered the option of repeating the verify operation with either the second side of the same disc or a different disc: Y selects this option; any other key returns to the main menu.

DISCKIT messages

Please insert the disc to *operation* into the drive
Press any key to continue

There is no disc in the drive
Please insert the disc to *operation* into the drive
R-etry or C-ancel?

The disc is write-protected
Please insert the disc to *operation* into the drive
R-etry or C-ancel?

That is the wrong disc
Please insert the disc to *operation* into the drive
Press any key to continue

Disc error on [*drive:*] track *number*, sector *number*
- *comment about error type*
[*comment about its location*]
R-etry[, I-gnore] or C-ancel?

This utility is described in Chapter 2 ('Copying discs' and 'Formatting discs')

ERASE

Deletes the reference to one or more files from a disc's directory. Directory and data space on the disc are automatically reclaimed for subsequent use by other files.

ERASE can be shortened to ERA.

ERASE *filespec* erases the file with the given file specification.

ERASE *filespec-including-wildcards* erases **all** files with file specifications that match the given specification. It first asks for confirmation that the file specification has been entered correctly. This version should only be used with great care.

ERASE *filespec-including-wildcards* [C] prompts for confirmation before erasing each file with a file specification matching the given specification. Type Y to confirm the action; N to keep the file.

If the system fails to find any file matching the given specification, the message No File is displayed.

Examples

A>ERASE MYFILE.10
erases MYFILE.10 from the disc in the default drive (Drive A).

A>ERA *.BAK
ERASE *.BAK (Y/N)?Y
erases all files with the filetype BAK from the disc in the default drive (Drive A), having first asked for confirmation.

A>ERA B:*. *
ERASE B:*. * (Y/N)?Y
erases all files from the disc in Drive B, having first asked for confirmation.

A>ERA B:*.BAK [C]
erases the files with the filetype BAK from the disc in Drive B one by one, asking each time for confirmation.

This command is described in section 2.8 ('Erasing files')

GET

Instructs the system to take the input it would normally get from the console (ie the keyboard) from a named file. This input can be either CP/M commands or the data needed by a program or both.

The console input is taken from the named file until that file is exhausted or the program terminates.

Unless instructed otherwise through one of the GET utility options, the input is echoed on the monitor screen. Options are listed between square brackets, separated by commas or single spaces.

GET CONSOLE INPUT FROM FILE *filespec* tells the system to get the input for the program that is about to be run from the file with the given file specification, until that file is exhausted or the program terminates. The command to run the program must be the next instruction typed in at the keyboard. All the inputs from the file are displayed on the screen.

GET CONSOLE INPUT FROM FILE *filespec* [SYSTEM] tells the system to take all the input it would normally expect from the console from the file with the given file specification, until that file is exhausted. This file will include instructions to run programs as and when required. All inputs from the file are displayed on the screen.

GET CONSOLE INPUT FROM FILE *filespec* [NO ECHO] tells the system to get the input for the program that is about to be run from the file with the given file specification, until that file is exhausted or the program terminates. The command to run the program must be the next instruction typed in at the keyboard. The inputs from the file are not displayed on the screen.

GET CONSOLE INPUT FROM CONSOLE tells the system to once again get its input from the keyboard. This terminates a preceding GET FILE command.

Examples

A>GET CONSOLE INPUT FROM FILE CONSIN.DAT [NO ECHO]

A>MYPROG

tells the system to get all the console input required by MYPROG from a file on the disc in the default drive called CONSIN.DAT. This input will not be displayed on the screen as the program is run.

A>GET CONSOLE INPUT FROM FILE B:CONSIN.CAD [SYSTEM,NO ECHO]

tells the system to take all its console input from the file on the disc in Drive B called CONSIN.CAD, until that file is exhausted. This input will not be echoed on the screen.

This utility is not covered any further in this manual.

INITDIR

Used in conjunction with the SET utility either to allow date and time stamping of the files on the disc in a specified drive or to remove this facility if it is already in force. INITDIR reformats the directory and, if there are any files already on the disc, checks that there is enough room in the directory for date and time stamping of these files. If not, it fails to reformat the directory and puts up an error message.

INITDIR *drive*: reformats the directory of the disc in the specified drive, either to allow date and time stamping, or to remove this information if the facility is already in force. The user is asked to respond to self-explanatory messages.

Example

A>INITDIR B:

reformats the directory of the disc in Drive B.

This utility is not covered any further in this manual. Moreover, it is incompatible with the PCW8256 word processing system and so we recommend that you do not use this feature on any disc that you also use to store word processing files.

PIP

Transfers data from a logical input device (the Source) to a logical output device (the Destination). For example, it can be used to copy one or more files from one disc to another; to output on the printer a character file from a disc; or to create a file on disc from input at the keyboard.

It can also combine inputs from two or more sources into one output.

PIP transfers any file attributes of the source file to the destination file and respects passwords as and where applied. As the full password features of CP/M Plus are not supported on the PCW8256, the latter aspect of PIP is not covered in this manual.

The operation of PIP may be terminated by typing [stop].

PIP *dest-filespec* = *source-filespec* copies the named source file and stores the copy as the file with the given destination file specification. This version can be used to duplicate a file on the same disc. *dest-filespec* is also used here to represent one of AUX:, CON:, PRN: or LST:, while *source-filespec* may also be one of AUX:, CON:, NUL:, or EOF:.

CON:	represents the console (keyboard and screen);
AUX:	any auxiliary input/output device;
LST: and PRN:	the printer;
NUL:	a source that produces 40 hexadecimal zeros;
EOF:	a source of a single 'Control-Z' character.

The files so copied must contain only printable characters.

PIP *dest-filespec* = *drive* : copies the file on the disc in the specified drive with the same filename and filetype as the destination file onto the destination disc, where it is stored with that filename and filetype. This version is not applicable to duplicating a file on the same disc.

PIP *drive* : = *source-filespec* copies the named source file onto the disc in the specified drive, where it is stored with the same filename and filetype. This version is not applicable to duplicating a file on the same disc.

PIP *drive* : = *filespec-including-wildcards* copies onto the disc in the specified drive, all files whose file specifications match the given file specification. The files are stored on the destination disc with the original filenames and filetypes. The message Copying *actual filename filetype* is displayed as each file is copied. This version cannot be used to duplicate files on the same disc.

PIP *dest-filespec*–*sourcespec-1* [,*sourcespec-2*] [,*sourcespec n*] combines the listed files in order of listing and stores the result as a file with the given destination file specification. This file may be stored on the same disc as the source files.

PIP enters PIP's Multiple Command Mode, in which it prompts for the next in a sequence of PIP type commands by putting up an asterisk on the screen. The next command should be entered as in any other PIP instruction but without the PIP. Terminate by typing [RETURN] after the asterisk.

All the above variants may be enhanced by using the PIP utility options.

One or more options may be listed at the end of the command line, between square brackets and separated by single spaces. There should be no space between the end of the main command and the bracketed options.

The options available are listed below.

PIP options

Option	Result
C	Confirmation is requested before each element of the copy operation is executed.
E	The transfer is echoed on the screen.
F	All form feeds embedded in the source file are removed.
G <i>n</i>	The file is identified as belonging to user number <i>n</i> .
L	All upper case characters are converted to lower case characters.
N	Line numbers are added to the destination file.
O	Ensures that the whole of the file is transferred, when non-printable characters within the file could be interpreted as an end-of file marker by PIP.
P <i>n</i>	The number of lines per page in the destination file is set to <i>n</i> .
Q <i>string</i> 'Control-Z'	The copying process terminates after the given string.
R	The source file may be found in the directory of system files, which is not normally searched.
S <i>string</i> 'Control-Z'	The copying process starts at the beginning of the given string.
U	All lower case characters are converted to upper case characters.
V	The destination file is compared with the source file to check that the copying process has been accurate.
W	Storing the copy may overwrite a read-only file with the same file specification.
Z	The parity bit of each data byte in the destination file is set to zero.

Examples

A>PIP B:=PR*.?X[SDear Sir'Control-Z'Qfaithfully'Control-Z]
identifies each file on the default disc whose file specification matches the given specification and then copies the portion of that file between 'Dear Sir' and 'faithfully' into a file with the identical filename and filetype on the disc in Drive B.

A>PIP CHAP1.TEX=SECT1.TX,SECT2.TX,SECT3.TX
combines the contents of the files SECT1.TX, SECT2.TX and SECT3.TX into a single file which is subsequently stored as the file CHAP1.TEX. All the files concerned are on the disc in the default drive (Drive A).

A>PIP LST:=B:LETTER.TX[E P40]
lists out on the printer the text contained in the file LETTER.TX on the disc in Drive B, starting a new page every 40 lines. The output is echoed on the screen.

A>PIP LST:=CON:[U N P40]
lists out on the printer everything that is typed in at the keyboard, starting a new page every 40 lines. Additionally, all lower case characters are converted to upper case and the lines are numbered in sequence.

A>PIP
*CHAP1.TEX=SECT1.TX,SECT2.TX,SECT3.TX
*LST:=CHAP1.TEX[P50]
*[RETURN]
combines the contents of the files SECT1.TX, SECT2.TX and SECT3.TX into a single file which is stored as the file CHAP1.TEX: then lists this new file out on the printer, starting a new page every 50 lines.

This utility is described in Chapter 2 ('Copying files')

PUT

Instructs the system to send console (ie. screen) output or printer output to a disc file, either until instructed otherwise or until the end of the program which is about to be run.

One or more options may be listed in square brackets as part of the instruction. These should be separated by commas or single spaces.

Unless instructed otherwise, control characters will not be incorporated in any form in the file. console output will also be displayed (ie. echoed) on the screen but printer output will not be echoed on the printer.

PUT CONSOLE OUTPUT TO FILE *filespec* tells the system to direct console output to a file with the given file specification. The output will be echoed on the screen.

PUT PRINTER OUTPUT TO FILE *filespec* tells the system to direct printer output to a file with the given file specification. The output will not be echoed on the printer.

PUT CONSOLE OUTPUT TO FILE *filespec* [SYSTEM] tells the system to direct console output to the file with the given file specification, until told otherwise through a PUT CONSOLE OUTPUT TO CONSOLE instruction. The output will be echoed on the screen.

PUT PRINTER OUTPUT TO FILE *filespec* [SYSTEM] tells the system to direct printer output to the file with the given file specification, until told otherwise through a PUT PRINTER OUTPUT TO PRINTER instruction. The output will not be echoed on the printer.

PUT CONSOLE OUTPUT TO FILE *filespec* [NO ECHO] kills the automatic echoing of the console output on the screen.

PUT PRINTER OUTPUT TO FILE *filespec* [ECHO] causes the system to echo on the printer the output sent to the named file.

PUT CONSOLE OUTPUT TO FILE *filespec* [FILTER] causes the stored version of the console output to contain printable representations of the control codes issued.

PUT PRINTER OUTPUT TO FILE *filespec* [FILTER] causes the stored version of the printer output to contain printable representations of the control codes issued.

PUT CONSOLE OUTPUT TO CONSOLE tells the system to revert to sending console output solely to the screen.

PUT PRINTER OUTPUT TO PRINTER tells the system to revert to sending printer output solely to the printer.

Examples

A>PUT CONSOLE OUTPUT TO FILE CONSOUT.TEX [SYSTEM,FILTER]

causes all subsequent console output to be additionally stored as a file called CONSOUT.TEX on the disc in the default drive (Drive A), complete with printable versions of all the control codes. This will continue until a PUT CONSOLE OUTPUT TO CONSOLE instruction is issued.

A>PUT PRINTER OUTPUT TO FILE B:PRINOUT.TEX [FILTER,ECHO]

A>MYPROG

causes the printer output from MYPROG to be stored in a file on the disc in Drive B called PRINOUT.TEX, complete with printable versions of all the control codes. The output is also sent to the printer. The system will revert to only sending printer output to the printer when MYPROG terminates.

This utility is not covered any further in this manual.

RENAME

Changes the name of one or more files catalogued in the directory of a disc. It does not make new copies of the files.

The drive specifier in the new file specification must be identical to that in the old file specification. Additionally, the new specification may not be that of any existing file.

RENAME may be shortened to REN.

RENAME *new-filespec=old-filespec* changes the name of the file with the given old file specification to that corresponding to the new file specification.

RENAME carries out the above operation, having first prompted the user for the new and old file specifications.

RENAME *new-filespec including-wildcards=old-filespec-including wildcards* changes the name of each file matching the given old file specification to one corresponding to the new file specification, replacing the wildcard characters with the appropriate characters from the original file specification. The wildcards in the old and new file specifications must therefore correspond exactly.

If no file is found that matches the given old file specification, the message No File is displayed on the screen.

If there is already a file on the disc with the given new file specification, the message Not renamed: *filename.filetype* file already exists, delete (Y/N)? appears on the screen.

Examples

A>REN NEWLETTR.TX=OLDLETTR.TX
renames the file OLDLETTR.TX NEWLETTR.TX.

A>REN B:PR*.*?Y=B:SP*.*?X
renames, for example, the file SPAIN.TX PRAIN.TY, the file SPIN.MX PRIN.MY, and the file SPA.AX PRA.AY but leaves the file SPAIN.TEX unchanged.

This utility is described in section 2.15 ('Renaming files').

SETDEF

Defines and/or displays the disc search order, the drive used for temporary files and/or the filetype search order. The search order only affects the loading of programs and/or the execution of Submit (.SUB) files.

SETDEF displays the current disc search order, the drive used for temporary files and the current filetype search order.

SETDEF [TEMPORARY=*drive*:] sets the drive used for temporary files. The default setting is the system default drive.

SETDEF *drive*:|,*drive*:| sets the order in which drives are searched. The default is just to search the system's default drive or the specified drive. Use * to specify the default drive in the search order.

SETDEF [ORDER=(COM,SUB)] instructs CP/M to look up commands first as a COM file and then as a SUB file.

SETDEF [ORDER=(SUB,COM)] instructs CP/M to look up commands first as a SUB file and then as a COM file.

Further forms of SETDEF exist, but these are outside the scope of this manual.

Examples

A>SETDEF B:,*

instructs the system to search for each program file initially on the disc in Drive B, but if that fails to search for it on the disc in the default drive.

This utility is described in section 2.17 ('Shortening the command line').

SHOW

Displays information about the accessed discs, including the access mode, the amount of free disc space, the disc label, the number of files on the disc corresponding to each user number and the number of free entries in the disc's directory.

SHOW displays the access mode and the remaining space on the disc (in kilobytes) for each logged-in drive in turn.

SHOW *drive*: displays the access mode and the remaining space (in kilobytes) on the disc in the specified drive.

SHOW *drive*: [USERS] details all the user numbers applying to the disc, the number of files relating to each number and the number of free entries in the disc's directory.

SHOW *drive*: [DIR] displays the number of free entries in the disc's directory.

SHOW *drive*: [DRIVE] displays the characteristics of the specified drive.

Examples

```
A>SHOW
A: R0, Space:      4k
B: RW, Space:    104k

1A>SHOW [USERS]
Active User :      1
Active Files:    0   2   3   4
A: # of files:  10   2  11   1
A: Number of free directory entries: 28
```

This utility is described in section 2.1 ('Assessing the available space').

SUBMIT

Causes the batch of commands within a SUB file to be executed one by one, just as if they were typed in in succession at the keyboard.

The SUB file is made up of CP/M Plus commands, nested SUBMIT commands (if so desired) and input data for CP/M commands and/or CP/M programs. Command lines may be no more than 128 characters long. Lines of input data are each started by a <

If a program run from within the SUB file terminates before using all its associated input data, the message `Warning: Program input ignored` is displayed before the next command within the file is executed. If too few lines of input data are given, SUBMIT expects these to be entered at the keyboard.

The SUB file can incorporate variables representing up to nine SUBMIT command inputs, represented by \$1..\$9. If a \$ is to be included in the file for any other purpose, it must be inserted as \$\$

No filetypes are required in SUBMIT instructions.

`SUBMIT filespec` causes the set of commands contained within the specified SUB file to be executed line by line.

`SUBMIT filespec input1[inputN]` causes the set of commands contained within the specified SUB file to be executed line by line with \$1 replaced by *input1*, and so on.

`SUBMIT` prompts for the specification of the SUB file to be executed and for any inputs that are required.

Example

A>SUBMIT SUBFILE INPUTA INPUTB

causes the commands within SUBFILE.SUB (which refers to \$1 and \$2) to be executed line by line, replacing \$1 by INPUTA and \$2 by INPUTB throughout.

This utility is described in section 2.14 ('Personalising your system').

TYPE

Displays the contents of an ASCII file on the monitor, either a screenful at a time (press the space bar to see the next screenful) or continuously. Press [stop] to return to CP/M.

TYPE *filespec* displays the contents of the file with the given file specification a screenful at a time.

TYPE *filespec* [NO PAGE] displays the contents of the file with the given file specification continuously.

If no file is found with the given file specification, the message No File is displayed.

This command is described in section 2.12 ('Listing a file').

USER

Sets the user number, with the result that all files subsequently created are assigned this user number and access is restricted to files with this number and to system files with user number 0.

The user number may take any value between 0 and 15. The default value is zero. However, the numbers 8..15 should not be applied to files stored on discs which are also written to by LocoScript software as this labelling could be misinterpreted and the files deleted.

The current user number setting is reflected in the current system prompt.

USER *number* changes the current user number to *number*. If no number is specified, a screen message appears that asks for the required number. The system responds with a modified system prompt.

Example

A>USER 3
3A>

changes the current user number from its default value of 0 to 3. Newly created files will be stored under this user number and the user now only has access to files with this user number and system files with user number 0. Note the changed system prompt.

This utility is not covered any further in this manual.

5.2 Setting up the hardware

DATE

Sets and displays the date and the time of day.

DATE displays the current setting of the computer's clock. Unless set by the user at some time during the current computing session, the date will display the creation date of the CP/M and the time of day, the number of hour, minutes and seconds since the start of the computing session.

DATE *MM/DD/YY hh:mm:ss* sets the computer's clock. *MM* is the month represented by 01..12; *DD* is the day represented by 01..31; *YY* is the last two digits of the year, represented by 00..99; *hh* is the hour, represented by 00..23; *mm* is the number of minutes, represented by 00..59; and *ss* is the number of seconds, represented by 00..59. The system responds with **Strike** any key to set time and starts the clock at the given time when you press a key.

The clock settings are not supported when the PCW8256 is running the LocoScript software and so the use of the **DATE** utility is not recommended.

DEVICE

Assigns the logical CP/M Plus devices to the physical devices (peripherals) attached to the PCW8256 and sets the associated communications parameters. It may also be used to display the current assignments of the logical devices, together with related information.

CP/M Plus supports the following five logical devices:

CONIN: console input (ie the keyboard)
CONOUT: console output (ie the monitor)
AUXIN: input side of an auxilliary device (eg a communications interface)
AUXOUT: output side of an auxilliary device (eg a communications interface)
LST: the printer

The physical devices that can appear in **DEVICE** commands depend on the details of the hardware configuration.

DEVICE NAMES lists the physical devices acceptable to the PCW8256, together with a summary of their basic characteristics, making a total of three elements in the list per device.

DEVICE VALUES lists the current logical device assignments.

DEVICE *physical-device* displays the characteristics of the named physical device.

DEVICE *logical device* displays the current assignment of the named logical device.

DEVICE *logical-device=physical-device* [*option*[,*option*]] assigns the named logical device to the named physical device.

DEVICE *logical-device=physical-device1,physical-device2[,physical deviceN]* sets the named logical device simultaneously to two or more physical devices.

DEVICE *logical-device=NULL* disconnects the named logical device from all physical devices.

DEVICE lists both the physical devices acceptable to the system (with their basic characteristics) as for DEVICE NAMES and the current assignments of the logical devices. It then prompts the user for new device assignments, which take the form *logical-device=physical-device*

DEVICE options

The options associated with the DEVICE utility are used to qualify individual physical devices. They generally apply only when a serial and/or parallel communications interface such as the Amstrad RS232C/Centronics Interface is fitted.

They should be listed between square brackets and separated by commas, after the physical device to which they apply. There should be a single space between the name of the device and the bracketed options.

With such an interface fitted, any listing of the physical devices fitted through a DEVICE command will include entries for SIO and CEN. In addition, AUXIN: and AUXOUT: will be automatically assigned to SIO when the machine is booted.

XON activates the signalling procedure whereby the peripheral device notifies the computer whether it is ready to receive more data.

NOXON results in the computer sending data to the peripheral device whether it is ready to receive it or not.

n sets the rate at which data is sent to the peripheral device (the Baud Rate). The allowed values for *n* are:
50, 75, 110, 134.5, 150, 300, 600, 1200, 1800, 2400, 3600, 4800, 7200, 9600 and 19200.

Only some of these values may be appropriate to any particular device.

Examples

A>DEVICE

Physical Devices:
I=Input, O=Output, S=Serial, X=Xon-Xoff
CRT NONE IO LPT NONE O

Current Assignments:
CONIN: = CRT
CONOUT: = CRT
AUXIN: = Null Device
AUXOUT: = Null Device
LST: = LPT

Enter new assignment or hit RETURN:

A>DEVICE CONOUT:= SIO
assigns the serial interface port as the logical console output.

A>DEVICE AUXIN:=NULL
disconnects the logical device AUXIN from all PCW8256 peripheral devices.

This utility is not covered any further in this manual.

LANGUAGE

Selects one of the eight internationally recognised character sets, with the result that certain keystrokes may cause different characters to appear on the screen and on the printer.

The characters that can change are listed in Appendix I.

The default setting is Language 0, the US set.

LANGUAGE *n* sets the character set to that identified by the number *n*.

Language identifiers

- 0 USA
- 1 France
- 2 Germany
- 3 UK
- 4 Denmark
- 5 Sweden
- 6 Italy
- 7 Spain

This utility is described in Appendix I ('CP/M Plus character sets').

PALETTE

Used to change the screen display from light characters on a black background to its reverse video counterpart and back again.

PALETTE 1 0 sets reverse video (black characters on a light background).

PALETTE 0 1 sets normal video (light characters on a black background).

This utility is not covered any further in this manual.

PAPER

Sets the parameters such as page length and number of lines per inch that are needed to use the printer effectively. These can be set piecemeal as the latest value of any of the parameters is the one that applies.

The PAPER utility can be used with almost any Epson compatible printer, not just the printer supplied with the PCW8256.

PAPER *option* [, *option*] sets one or more of the paper parameters. The options are separated by commas or single spaces and may be given in any order. Some of the options affect the settings of other parameters, unless these are set explicitly in the same command line.

The options are used to generate printer control codes which are sent to the printer. As the commands are obeyed, they are reported on the screen.

The options are:

- FORM LENGTH *n* sets the form length (page length). *n* is the length given as the equivalent number of lines and must be in the range 6..99. If the Line Pitch is not set explicitly in the same PAPER command, then it is set to six lines per inch both for subsequent use and for the purposes of the current command. If the Gap Length is not set explicitly in the same command, it is set to zero.
- GAP LENGTH *n* sets the gap (number of lines of the page skipped over) at the bottom of the page. *n* must be in the range 0..99. If the Line Pitch is not set explicitly in the same PAPER command and *n* is not zero, then the line pitch is set to six lines per inch both for subsequent use and for the purposes of the current command.
- LINE PITCH *n* sets the line pitch (number of lines printed per inch). *n* may be either 6 or 8.
- SINGLE SHEET selects use of single sheet stationery. If Paper Out Defeat is not set explicitly in the same PAPER command, it is set to ON.
- CONTINUOUS STATIONERY selects use of continuous stationery. If Paper Out Defeat is not set explicitly in the same PAPER command, it is set to OFF.

PAPER OUT DEFEAT *s* sets whether the Paper End Detector is ignored. *s* can be either ON or OFF.

A4 sets the parameters for A4 paper. These are:
Form Length 70 lines
Line Pitch 6 lines per inch
Gap Length 3 lines
Single Sheet stationery
Paper Out Defeat ON

A5 sets the parameters for A5 paper. These are:
Form Length 50 lines
Line Pitch 6 lines per inch
Gap Length 3 lines
Single Sheet stationery
Paper Out Defeat ON

n sets the parameters for continuous stationery with a form length of *n* inches. These are:
Form Length *n* inches
Line Pitch 6 lines per inch
Gap Length 0
Continuous stationery
Paper Out Defeat OFF

n must be in the range 1 . . 17.

DEFAULTS saves the current printer settings for use when the printer is reset.

FORM LENGTH may be shortened to F; GAP LENGTH to G; LINE PITCH to L; SINGLE SHEET to S; CONTINUOUS STATIONERY to C; PAPER OUT DEFEAT to P; and DEFAULTS to D.

Examples

A>PAPER FORM LENGTH 70

first sets the Line Pitch to 6 lines per inch and then sets the Form Length to 70 lines in this pitch. The Gap Length is set to zero.

A>PAPER F 70, L 8

first sets the Line Pitch to 8 lines per inch and then sets the Form Length to 70 lines in this pitch. The Gap Length is set to zero.

A>PAPER A4

first sets the Line Pitch to 6 lines per inch and then sets the Form Length to 70 lines in this pitch and the Gap Length to 3 lines. The printer is set to expect Single Sheet stationery and the Paper End detector is ignored.

This utility is introduced in section 2.13 ('Operating the printer').

SETKEYS

Configures the keyboard in accordance with data contained within a pre-defined Key Definition File. The keys are set to return a character, a control code or some string of characters and control codes (an Expansion String).

The key definition file comprises a number of lines, each of which have one of the following forms:

```
key no [shift state] "char" [comment]
key-no [shift state] "escape sequence" [comment]
key-no [shift state] "expansion-token" [comment]
E expansion-token "expansion-string" [comment]
```

The first two forms and the third and fourth together define the response following the specified key being pressed in the specified shift state(s).

The key numbers are obtainable from the diagram in Appendix I.

The shift states are: N or nothing for No shift; S for $\overline{\text{SHIFT}}$; A for $\overline{\text{ALT}}$; E for $\overline{\text{EXTRA}}$; and SA for $\overline{\text{SHIFT}} + \overline{\text{ALT}}$. More than one shift state can be given in the definition, the entries separated by single spaces. In that case, the definition applies to all the named shift states.

Most simple characters can be inserted in the key definition file by pressing the current key with that effect, but ^ and " have to be entered as ↑↑ and ↑", respectively. ^ is obtained on a standard PCW8256 by $\overline{\text{EXTRA}} + \text{U}$ or $\overline{\text{EXTRA}} +$;

A character that cannot be typed at present is entered by quoting its internal code in terms of either its decimal or its hexadecimal value. " ^ 'value'" then replaces "char" in the standard key definition sequence. The decimal and hexadecimal values of every character are tabulated in Appendix I).

The control code 'Control-char' is represented in the key definition file by the escape sequence ^ char.

Where the control is known by a name, the special escape sequence ↑ 'name' may be used.

The expansion token can be any hexadecimal number between #80 and #9E. The expansion string can be made up of both characters and escape sequences with the escape sequences represented by ↑ char or ↑ 'name'

The optional comment is intended to be used to remind the user of the action of the key definition on that line. Any text may be inserted here.

SETKEYS filespec configures the keyboard in accordance with the data within the file with the given file specification.

Lines within the file that contain errors will generate error messages but will otherwise be ignored.

Example

To see an example of a Key Definition File, list either KEYS.WP (on Side 2) or KEYS.DRL (on Side 4).

This utility is described in Appendix I ('CP/M Plus character sets').

SETLST

Sends the string of characters and control codes needed to initialise the printer. These characters are taken from data within a pre-defined Printer Definition File.

The string of characters and control codes required to initialise will be given in the manual for that printer. These should be entered in the printer definition file according to the following syntax:

Most simple characters are inserted in the printer definition file by pressing the current key with that effect, but ^ and " have to be entered as ↑ ^ and ↑ ", respectively. ↑ is obtained on a standard PCW8256 by [EXTRA]+U or [EXTRA]↑;

A character that cannot be typed at present is entered by typing ↑ 'value', where *value* is that character's internal code, given in terms of either its decimal or its hexadecimal value. This syntax can, in fact, be used for any character. The decimal and hexadecimal values of every character are tabulated in Appendix I.

A control code can be represented in one of three ways. If it can be entered at the keyboard by typing [ALT] + *char*, then it can be represented by the escape sequence ↑ *char*. Where the control code is known by a name, such as ESC or BEL, the special escape sequence ↑ '*name*' may be used. The third way is to quote its internal code. This has the same syntax as quoting the internal code of a character, i.e. 'value', where *value* is either the decimal or hexadecimal value of the internal code.

SETLST *filespec* sends a string of characters to the printer to initialise it. The string of characters is taken from the file with the given file specification.

Example

```
A↑ 'BEL'55↑ G↑ '233'
```

is the character string corresponding to A; BEL code; 5; 5; Control-G; u

This utility is described in Appendix II ('Advanced use of the printer').

SETSIO

Sets the parameters of the serial interface, provided for example by the Amstrad RS232C/Centronics Interface. These can be set piecemeal as the latest value of any of the parameters is the one that applies.

SETSIO *option* [*option*] sets one or more of the interface parameters, then displays all the current settings. The options are separated by single spaces and are taken in any order from:

TX <i>n</i>	sets the transmitter baud rate
RX <i>n</i>	sets the receiver baud rate
<i>n</i>	sets both baud rates to the same value
BITS <i>n</i>	sets the number of data bits (5, 6, 7 or 8)
STOP <i>n</i>	sets the number of stop bits (1, 1.5 or 2)
PARITY <i>type</i>	sets the parity type (EVEN, ODD or NONE)
XON <i>state</i>	sets the XON protocol to ON or OFF
HANDSHAKE <i>state</i>	sets the handshake to ON or OFF
INTERRUPT <i>state</i>	sets the interrupt driven input to ON or OFF

TX may be shortened to T; RX to R; STOP to S; BITS to B; PARITY to P; XON to X; and HANDSHAKE to H

The allowed baud rates are 50, 75, 110, 134.5, 150, 300, 600, 1200, 1800, 2400, 3600, 4800, 7200, 9600 and 19200

In the absence of any specific setting of the number of stop bits, this value will be set to 2 if the baud rate is 50, 75 or 110 but to 1 for any other value of the baud rate.

Any illegal option will generate an error message but otherwise just be ignored.

Examples

```
A>SETSIO
```

```
9600 Bits 8 Parity none Stop 1 Xon off Handshake on Interrupt off
```

```
A>SETSIO P EVEN
```

```
9600 Bits 8 Parity even Stop 1 Xon off Handshake on Interrupt off
```

```
A>SETSIO P EVEN, X ON, BITS 7
```

```
9600 Bits 7 Parity even Stop 1 Xon on Handshake on Interrupt off
```

This utility is not covered any further in this manual.

SET24X80

Sets the screen size to 24 lines by 80 characters regardless of the actual screen size. This screen size is required by some application programs.

Alternatively, it restores the screen to its normal size of 31 lines by 90 characters.

SET24X80	sets 24 × 80 mode.
SET24X80 ON	sets 24 × 80 mode.
SET24X80 OFF	restores the screen's normal characteristics.

This utility is not covered any further in this manual.

5.3 Advanced programming tools

DUMP

Displays on screen the contents of a file in both hexadecimal and ASCII format.

DUMP *filespec* displays in this form the contents of the file with the given file specification.

Example

```
CP/M 3 DUMP - Version 3.0
0000: 18 6B 4C 41 4E 47 55 41 47 45 20 23 31 30 35 0D .kLANGUAGE #105.
0010: 0A 44 65 76 65 6C 6F 70 65 64 20 62 79 20 4C 6F .Developed by Lo
0020: 63 6F 6D 6F 74 69 76 65 20 53 6F 66 74 77 61 72 comotive Softwar
0030: 65 20 4C 74 64 2E 0D 0A 43 6F 70 79 72 69 67 68 e Ltd...Copyrigh
0040: 74 20 28 43 29 20 31 39 38 35 20 41 6D 73 74 72 t (C) 1985 Austr
0050: 61 64 20 43 6F 6E 73 75 6D 65 72 20 45 6C 65 63 ad Consumer Elec
0060: 74 72 6F 6E 69 63 73 20 50 4C 43 0D 0A ED 73 00 tronics PLC...s.
0070: 11 31 02 12 CD 5F 03 CD E1 02 DC 82 01 ED 7B 00 .1.....(
0080: 11 C9 79 FE 03 CA 03 02 CD 59 02 28 0F 3E 1B CD ..y.....V(..)
0090: AF 01 3E 32 CD AF 01 7D C6 20 18 13 11 A2 01 C3 ..)2...), .....
00A0: BE 01 42 61 64 20 6E 75 6D 62 65 72 0D 0A 24 E5 ..Bad number...$.
00B0: D5 C5 F5 5F 0E 06 CD 05 00 F1 C1 D1 E1 C9 C5 F5 ..V.....(
00C0: CD 3C 02 CD 59 03 20 1D 11 E8 01 CD 3C 02 18 04 .y.J..T..y.....(
00D0: 79 CD 4A 02 CD 54 03 CD 59 03 CD FD 02 28 F1 11 ..<....Ignoring
00E0: 00 02 CD 3C 02 F1 C1 C9 49 67 6E 6F 72 69 6E 67 rest of line: $
00F0: 20 72 65 73 74 20 6F 66 20 6C 69 6E 65 3A 20 24 ..$.....(....This
0100: 0D 0A 24 95 11 0C 02 CD 3C 02 D1 C9 54 68 69 73 program will no
0110: 20 70 72 6F 67 72 61 6D 20 77 69 6C 6C 20 6E 6F t run in this en
0120: 74 20 72 75 6E 20 69 6E 20 74 68 69 73 20 65 6E vironment...$....
0130: 76 69 72 6F 6E 6D 65 6E 74 0D 0A 24 E5 D5 C5 F5 ..o.....(.....X(
0140: 0E 09 CD 05 00 F1 C1 D1 E1 C9 E5 D5 C5 F5 5F 0E .....X(!.....)T)
0150: 02 CD 05 00 F1 C1 D1 E1 C9 C5 CD D1 02 CB 58 28 ..)y.o.o.g....I
0160: 05 CD 6F 02 18 07 CB 60 28 03 CD 9A 02 C1 C9 D5 ..X.....(
0170: C5 CD D1 02 CB 58 28 1F 21 00 00 18 06 5D 54 29 ..(-...T..P...(!
0180: 29 19 29 79 D6 30 85 6F 8C 95 67 CD FD 02 CD 54 ..)))))y...X...
0190: 03 CB 58 20 E8 F6 01 C1 D1 C9 C5 CD D1 02 CB 60 ..o....T..P...
01A0: 28 2D CD FD 02 CD 54 03 CB 50 CC 1F 03 28 20 21
01B0: 00 00 18 04 29 29 29 29 79 E6 0F CB 58 20 02 C6
01C0: 09 B5 6F CD FD 02 CD 54 03 CB 50 20 E7 F6 01 C1
Press RETURN to continue █
```

This utility is not covered any further in this manual.

ED

Edits the disc file with the given file specification. It is the CP/M Plus Text Editor, and it responds to its own set of commands (tabulated below).

It may also be used to create a new disc file.

After opening the source and destination files, ED displays the prompt

: *

indicating that it is ready to receive an editing command. This prompt is repeated whenever the current command is completed.

ED *filespec* opens the file with the given file specification. The edited file takes over the source file's entry in the directory. The old version is retained with the filetype BAK. If no source file is found, the message NEW FILE is displayed, followed by : *.

ED *source-filespec dest-filespec* opens the file with the given source file specification. The edited file is stored as a file with the given destination file specification. The old version is retained with its original file specification.

ED *filename.filetype B:* opens the file on the disc in the default drive (Drive A) that has the given filename and filetype. The edited file is stored on the disc in Drive B with the same filename and filetype. The old version is retained with its original file specification.

Type E to end the edit.

Examples

A>ED MYPROG.1

causes the file MYPROG.1 on the disc in Drive A to be opened for editing. The new version is stored as MYPROG.1, while the old version is stored as MYPROG.BAK. If the file MYPROG.1 doesn't already exist, a file with this name is created on Drive A.

A>ED MYPROG.1 B:

causes the file MYPROG.1 on the disc in Drive A to be opened for editing. The new version is stored as MYPROG.1 on the disc in Drive B.

This utility is described in sections 2.4 and 2.7 ('Creating files', and 'Editing text files').

ED commands

Command	Action
<i>n</i> A	appends <i>n</i> lines from the source file to the ED workspace
\emptyset A	appends lines from the source file until the workspace is half full.
#A	appends lines from the source file until the workspace is full or the end of file is reached.
B, -B	moves the workspace pointer to the beginning (B) or end (-B) of the workspace.
<i>n</i> C	moves the workspace pointer <i>n</i> characters forward through the workspace (backwards if <i>n</i> is negative).
<i>n</i> D	deletes the <i>n</i> characters after the workspace pointer (before if <i>n</i> is negative).
E	saves the new file and returns to CP/M.
F <i>string</i> 'Control-Z'	finds the specified character string in the workspace beyond the current position of the pointer.
H	saves the current version of the file, then reopens the edit using this file as the source.
i	enters insert mode. Type [EXIT] to leave this mode.
i <i>string</i> 'Control-Z'	inserts the given string at the position of the workspace pointer.
<i>n</i> K	deletes the <i>n</i> lines after the workspace pointer (before if <i>n</i> is negative).
<i>n</i> L	moves the workspace pointer <i>n</i> lines forward through the workspace (backwards if <i>n</i> is negative).
\emptyset L	moves the workspace pointer to the beginning of the current line.
<i>n</i> M <i>commands</i>	instructs ED to execute the given commands <i>n</i> times.
<i>n</i>	moves the workspace pointer <i>n</i> lines forward (backwards if <i>n</i> is negative) and displays that line.
<i>n</i> :	moves the workspace pointer to line <i>n</i> and displays that line.
0	abandons the editing so far, returning to the original version for re-editing.
<i>n</i> P	moves the workspace pointer <i>n</i> lines forward through the workspace (backwards if <i>n</i> is negative) and displays all those lines.
Q	abandons the edit and returns to CP/M.
R <i>filespec</i> 'Control-Z'	reads the named file into the ED workspace, appending it to whatever is already in there.
<i>n</i> S <i>old-string</i> 'Control-Z' <i>new-string</i>	replaces <i>n</i> instances of <i>old string</i> with <i>new string</i> , the search being carried out forwards from the current position of the workspace pointer.
<i>n</i> T	displays the <i>n</i> lines after the workspace pointer (before it if <i>n</i> is negative), leaving the pointer in its current position.
<i>n</i> W	writes the first <i>n</i> lines in the workspace to the destination file.
<i>n</i> X <i>filespec</i>	writes <i>n</i> lines from the workspace into the named file, appending them to any other lines already in that file through a previous <i>n</i> X <i>filespec</i> instruction.

ED error messages

All the error messages generated within the text editor have the same form:

```
BREAK "symbol" AT letter
```

The symbol identifies the type of failure (tabulated below) while the letter is that of the current editing command.

Symbol

#	Search failure: specified string not found
? <i>letter</i>	Unrecognised command letter: can also imply command not correctly specified
Ø	LIB file specified in an R command not found
>	Buffer full or specified string too long
E	Command aborted
F	File error (followed by either DISK FULL or DIRECTORY FULL)

GENCOM

Attaches one or more Resident System Extension (RSX) to a command file, thereby enabling the program within the command file to use the facilities of the named RSX's.

Resident system extensions are additional operating system modules, temporarily held in the computer's memory, that extend or modify the way CP/M Plus operates.

A maximum of 15 RSX's may be attached at one time.

The GENCOM utility is also used to return the command to its original state.

This utility is not covered any further in this manual.

HEXCOM

Generates a command file from a hexadecimal format file.

This utility is not covered any further in this manual.

LIB

Either creates a library of object modules or appends, replaces, selects or deletes modules from an existing library. It may also be used to obtain information about the contents of an existing library.

The object modules must be in Microsoft REL format, as produced for example by the RMAC utility .

Library files are given the filetype REL.

This utility is not covered any further in this manual.

LINK

Combines relocatable object modules into a command file.

The object modules are held either in individual files (the form in which they are produced, for example, by RMAC) or in libraries.

This utility is not covered any further in this manual.

MAC

MAC is CP/M Plus's Macro Assembler.

Takes an assembler program (filetype ASM) and produces a HEX (hexadecimal format) file, a PRN file (suitable for output on the screen or the printer) and a SYM file. The latter contains a sorted list of the symbols defined in the program.

This utility is not covered any further in this manual.

PATCH

Puts the specified patch into the named system or command file. It may also be used to display the specified patch.

This utility is not covered any further in this manual.

RMAC

RMAC is CP/M Plus's Relocatable Macro Assembler.

Converts an assembler program file (filetype ASM) into a relocatable (REL) file, that can then be linked to create a command (COM) file. Also produced are a PRN file (suitable for printing or displaying on the screen) and a SYM file. The latter contains a sorted list of the variables defined in the program.

This utility is not covered any further in this manual.

SAVE

Intercepts the return to the system following the execution of the next program and then copies the contents of the memory between specified hexadecimal addresses into a named file.

The utility prompts the user for the program to be run, the name of the file, the start address and the end address.

SAVE activates the utility.

Example

```
A>SAVE
A>MYPROG
...output from MYPROG...
File (or RETURN to exit)?DUMPFIL
From?100
To?400
```

causes the contents of the memory between hexadecimal addresses &100 and &400 following the running of the program MYPROG to be copied into a file on the disc in the default drive (Drive A) called DUMPFIL.

This utility is not covered any further in this manual.

SID

SID is CP/M Plus's Symbolic Instruction Debugger.

Enables the execution of programs to be monitored - by displaying the contents of the memory, displaying the contents of the CPU registers and directing breakpoint operations during debugging.

The associated utilities, TRACE.UTL and HIST.UTL, provide additional debugging tools. TRACE provides a trace back of the instructions that led to a particular breakpoint in the program under test: HIST produces a histogram showing the frequency with which code from selected program segments was accessed.

This utility is not covered any further in this manual.

XREF

Produces a file containing a cross-reference summary of the variable usage in an assembler program from the PRN and SYM files produced by prior operation of the MAC or RMAC utility on this program.

This utility is not covered any further in this manual.

5.4 Help

HELP

Provides technical information on the CP/M commands and utilities in an abbreviated form.

Prompts for a Topic on which information is required. The topics covered are listed by typing help

Some of the topics have subtopics such as EXAMPLES and OPTIONS associated with them. These can be accessed either as a subsidiary action to displaying the main information on the topic by just giving the name of the subtopic or directly from the initial HELP> prompt by giving both topic and subtopic. Only the second form is available if you wish to examine a second subtopic of the same topic.

Screen messages give details of the syntax that should be used.

The COMMANDS topic gives details of the conventions used in the rest of the text.

Topics covered

COMMANDS	CNTRLCHARS	COPYSYS	DATE	DEVICE
DIR	DISCKIT	DUMP	ED	ERASE
FILESPEC	GENCOM	GET	GSX	HELP
HEXCOM	INITDIR	LANGUAGE	LIB	LINK
MAC	PALETTE	PAPER	PATCH	PIP
PRINTER	PUT	RENAME	RMAC	SAVE
SET	SET24X80	SETDEF	SETKEYS	SETLST
SETSIO	SHOW	SID	SUBMIT	TYPE
USER	XREF			

This utility is not covered any further in this manual.

Appendix I

CP/M Plus character sets

The PCW8256 keyboard has been set up so that when the PCW8256 is running CP/M, 147 single key or multiple keystrokes produce printable characters and another 49 produce CP/M's control codes.

Forty-seven of these characters require just a single 'Character' key to be pressed. The rest are formed by pressing [SHIFT]+key, [ALT]+key, [EXTRA]+key or [SHIFT]+[ALT]+key.

The key combinations as supplied are listed in section I.2.

The set of characters available can be changed to take advantage of the whole range of 256 different characters that can be used on the PCW8256, 224 of which are already defined and the other 32 you can define yourself.

Each character is known to the PCW8256 by a code, usually represented as a decimal number between 0 and 255. The specific assignment of numbers to characters makes the PCW8256's codes an extended version of the industry standard ASCII character set.

The way the keyboard assignments can be changed is described in section I.3, and the full list of characters that can be used is given in section I.4, together with the corresponding internal codes both in decimal and in the hexadecimal notation.

There are, however, some special key combinations which cannot be altered because they affect the way the PCW8256 operates. One of these is [ALT]+[ENTER] which acts as a Caps Lock key, setting/clearing the translation of all lower case characters to upper case. Another is [ALT]+[RELAY] which acts as a Num Lock key, setting/clearing the use of the cursor and other function keys as a numeric keypad. The third special combination is, of course, [SHIFT]+[EXTRA]+[EXIT] which resets the machine.

It should be pointed out that while all 256 characters can be typed in at the keyboard, displayed on the screen and saved on disc, not all of them can be printed.

Moreover, some application programs will misinterpret any character with an internal hexadecimal value greater than #7F. These characters shouldn't be used with such programs.

These problems will particularly affect those wishing to use accented characters in producing foreign language texts.

1.1 The language variants

The selection of characters made available on computers sold in different countries is subject to national variations. A handful of the codes established as the standard in these countries differ from those used conventionally in the US.

These variations are supported on the PCW8256 and a special utility has been incorporated into the CP/M system to allow the user to swap between one 'Language' and another.

The utility that affects these changes is LANGUAGE, which is on Side 2 of the system discs, and the instruction to adopt a particular language variant is LANGUAGE *n*, where *n* is the number between 0 and 7 that corresponds to the required language.

Language 0 is the US code set and this is the one in force immediately after you boot the PCW8256 from the CP/M system disc. The complete list is:

Language	0: American
	1: French
	2: German
	3: English
	4: Danish
	5: Swedish
	6: Italian
	7: Spanish

Changing from one language to another will affect the characters generated by particular keystrokes. For example, whereas under Language 0 pressing [EXTRA] + 2 causes an umlaut ("") to be displayed, under Language 1 the displayed character will be a tilde (~) and under Language 7 it will be a curly bracket (}).

The full list of characters available via the PCW8256 keyboard under all the language variations is given in the next section, together with details of the key combinations required to obtain them on a standard PCW8256 where these have been set. For the moment, however, you should note that:

	Adds	Loses
Language	1 ä é û è	@ { }
	2 ä ö ü Ä Ö Ü	[] { } \
	3 (nothing)	(nothing)
	4 (nothing)	(nothing)-
	5 Ê É ä ö ü Ä Ö Ü	@ \ [] ↑ { }
	6 é à è ì ó	{ }] ^ ~
	7 ñ Ñ	\

Unlike the case in the PCW8256's word processor mode, under CP/M the user can change the codes which are generated by the keyboard. This is achieved through use of the SETKEYS utility, described in section I.3.

I.2 Characters available under CP/M

Symbol Description	Decimal value	Hex value	Key combination (Language 0)	Other languages
Alphanumerics				
a-z Lower case chars	97-122	#61-#7A	Unshifted	(Same)
A-Z Upper case chars	65-90	#41-#5A	[SHIFT] + [A-Z]	(Same)
0-9 Numerals	59-57	#31-#39	Unshifted	(Same)
æ L.case diphthong	246	#F6	[ALT] + 9	4: Unshifted
Æ U.case diphthong	214	#D6	[SHIFT] + [ALT] + 9	4 [SHIFT]
Textual symbols				
- Hyphen	45	#2D	Unshifted -	(Same)
, Comma	44	#2C	Unshifted, or [SHIFT] + ,	(Same)
. Full stop	46	#2E	Unshifted, or [SHIFT] + .	(Same)
; Semicolon	59	#3B	Unshifted ;	(Same)
: Colon	58	#3A	[SHIFT] + :	(Same)
! Exclamation mark	33	#21	[SHIFT] + 1	(Same)
? Question mark	63	#3F	[SHIFT] + ?	(Same)
Space	32	#20	Space bar	(Same)
& Ampersand	38	#26	[SHIFT] + 7	(Same)
' Apostrophe	39	#27	[SHIFT] + 6	(Same)
" Double quote	34	#22	[SHIFT] + 2	(Same)
_ Underline	95	#5F	[SHIFT] + _	(Same)
* Asterisk	42	#2A	[SHIFT] + 8	(Same)
# Hash	35	#23	Unshifted #	3: [SHIFT] + 3 7: [EXTRA] + 3
/ Slash	47	#2F	Unshifted /	(Same)
(Open parentheses	40	#28	[SHIFT] + 9	(Same)
) Close parentheses	41	#29	[SHIFT] + 0	(Same)
[Open square bracket	91	#5B	Unshifted [1,6: [EXTRA] + 5 2,5: Not set 4: [SHIFT] + [ALT] + 9 7: [EXTRA] + 1
] Close square bracket	93	#5D	Unshifted]	1: Unshifted § 2,6: Not set 4,5: [SHIFT] + [ALT] + 8 7: [EXTRA] + 1
{ Open curly brace	123	#7B	[SHIFT] + {	1,2,5,6: Not set 4: [ALT] + 9 7: [EXTRA] + 2
} Close curly brace	125	#7D	[SHIFT] + }	1,2,6: Not set 4,5: [ALT] + 8
@ At	64	#40	[SHIFT] + @	1,5: Not set 2: Unshifted
© Copyright	164	#A4	[EXTRA] + C	(Same)
® Registered	190	#BE	[EXTRA] + R	(Same)
™ Trade mark	191	#BF	[EXTRA] + T	(Same)
§ Section	166	#A6	Unshifted §	1: Unshifted] 2: [SHIFT] + 1
¶ Paragraph sign	165	#A5	[EXTRA] + P	(Same)
† Dagger	167	#A7	[EXTRA] + D	(Same)
○ Open circle	187	#BB	[ALT] + .	(Same)
● Bullet	188	#BC	[SHIFT] + [ALT] + .	(Same)
Currency symbols				
£ Pound	163	#A3	[SHIFT] + 3	3: Unshifted #
\$ Dollar	36	#24	[SHIFT] + 4	(Same)
c Cent	177	#B1	[EXTRA] + 4	(Same)
¥ Yen	189	#BD	[EXTRA] + Y	(Same)
₧ Peseta	173	#AD	[EXTRA] + 3	7: Unshifted #
f Florin (Dutch)	176	#B0	[EXTRA] + F	(Same)

Mathematical symbols

+	Plus	43	#2B	[SHIFT] +	(Same)
-	Minus	45	#2D	Unshifted	(Same)
=	Equals	61	#3D	Unshifted	(Same)
0	Zero with slash	48	#30	Unshifted 0	(Same)
1/2	Half	169	#A9	Unshifted 1/2 or [ALT] + 4	(Same)
1/4	One quarter	168	#A8	[ALT] + 2	(Same)
3/4	Three quarters	170	#AA	[ALT] + 6	(Same)
1/8	One eighth	182	#B6	[ALT] + 1	(Same)
3/8	Three eighths	183	#B7	[ALT] + 3	(Same)
5/8	Five eighths	184	#B8	[ALT] + 5	(Same)
7/8	Seven eighths	185	#B9	[ALT] + 7	(Same)
.	Decimal point	46	#2E	Unshifted or [SHIFT] +	(Same)
/	Slash	47	#2F	Unshifted	(Same)
<	Less than	60	#3C	[SHIFT] + \$	(Same)
>	Greater than	62	#3E	[SHIFT] + #	(Same)
<=	Less than or eq.	221	#DD	Not set	
>=	Greater than or eq.	220	#DC	Not set	
≠	Not equals	222	#DE	[EXTRA] +	(Same)
≈	Approx. equals	223	#DF	[ALT] +	(Same)
≅	Equivalent to	255	#FF	[SHIFT] + [ALT] +	(Same)
%	Percent	37	#25	[SHIFT] + 5	(Same)
(Open parentheses	40	#28	[SHIFT] + 9	(Same)
)	Close parentheses	41	#29	[SHIFT] + 0	(Same)
[Open square bracket	91	#5B	Unshifted [1.6: [EXTRA] + 5 2.5: Not set
]	Close square bracket	93	#5D	Unshifted]	4: [SHIFT] + [ALT] + 9 7: [EXTRA] + 1
{	Open curly brace	123	#7B	[SHIFT] + {	1: Unshifted \$ 2.6: Not set
}	Close curly brace	125	#7D	[SHIFT] + }	4.5: [SHIFT] + [ALT] + 8 7: [EXTRA] + 7
	Vertical bar	124	#7C	[EXTRA] +	1.2.5.6: Not set 4: [ALT] + 9
\	Backslash	92	#5C	[EXTRA] + \	7: [EXTRA] + 2
#	Hash	35	#23	Unshifted #	1.2.6: Not set 4.5: [ALT] + 8
°	Degrees	162	#A2	[EXTRA] + 5	1.2.5.6.7: Not set 4: [ALT] + 0
^	Exponentiation	94	#5E	[EXTRA] + U or [EXTRA] +	1: [ALT] + 2 2.5.7: Not set
					4: [SHIFT] + [ALT] + 0
					3: [SHIFT] + 3 7: [EXTRA] + 3
					1.6: Unshifted [
					5: Not set

Continental characters

a	Lower case A acute	224	#E2	Not set	
e	Lower case E acute	225	#E1	Not set	1: [SHIFT] + [5: [EXTRA] + 8
i	Lower case I acute	226	#E0	Not set	6: Unshifted]
o	Lower case O acute	227	#E3	Not set	
u	Lower case U acute	228	#E4	Not set	
À	Upper case A acute	192	#C0	Not set	
É	Upper case E acute	193	#C1	Not set	5: [SHIFT] + [
Ì	Upper case I acute	194	#C2	Not set	
Ó	Upper case O acute	195	#C3	Not set	
Û	Upper case U acute	196	#C4	Not set	
â	Lower case A circumflex	229	#E5	Not set	
é	Lower case E circumflex	230	#E6	Not set	
ì	Lower case I circumflex	231	#E7	Not set	
ó	Lower case O circumflex	232	#E8	Not set	
û	Lower case U circumflex	233	#E9	Not set	
Á	Upper case A circumflex	197	#C5	Not set	
É	Upper case E circumflex	198	#C6	Not set	
Ì	Upper case I circumflex	199	#C7	Not set	
Ó	Upper case O circumflex	200	#C8	Not set	

Ū	Upper case U circumflex	201	#C9	Not set	
a	Lower case A grave	234	#EA	Not set	
e	Lower case E grave	235	#EB	Not set	1: [SHIFT] · ½ 6: [SHIFT] + [
i	Lower case I grave	236	#EC	Not set	1,6: [SHIFT] ·]
o	Lower case O grave	237	#ED	Not set	6: [EXTRA] ·]
u	Lower case U grave	238	#EE	Not set	6: [EXTRA] ·]
Å	Upper case A grave	202	#CA	Not set	1: [EXTRA] + ½ 6: [EXTRA] + 8
E	Upper case E grave	203	#CB	Not set	
I	Upper case I grave	204	#CC	Not set	
O	Upper case O grave	205	#CD	Not set	
Ů	Upper case U grave	206	#CE	Not set	
ä	Lower case A umlaut	240	#F0	Not set	2,5: [SHIFT] + [
e	Lower case E umlaut	241	#F1	Not set	
i	Lower case I umlaut	242	#F2	Not set	
o	Lower case O umlaut	243	#F3	Not set	2,5: [EXTRA] ·]
ü	Lower case U umlaut	244	#F4	Not set	2: [SHIFT] ·] 5: [EXTRA] ·]
ÿ	Lower case Y umlaut	239	#EF	Not set	
Ä	Upper case A umlaut	202	#CA	Not set	2,5: Unshifted [
É	Upper case E umlaut	209	#D1	Not set	
Ï	Upper case I umlaut	210	#D2	Not set	
Ö	Upper case O umlaut	211	#D3	Not set	2,5: [EXTRA] + ½
Û	Upper case U umlaut	212	#D4	Not set	2: Unshifted [
Ÿ	Upper case Y umlaut	207	#CF	Not set	5: [EXTRA] · U or +]
ã	Lower case A tilde	250	#FA	Not set	
n	Lower case N tilde	249	#F9	Not set	7: [EXTRA] ·]
o	Lower case O tilde	251	#FB	Not set	
Å	Upper case A tilde	218	#DA	Not set	
N	Upper case N tilde	217	#D9	Not set	7: [EXTRA] + ½
Ö	Upper case O tilde	219	#DB	Not set	
ä	Lower case A ring	247	#F7	[ALT] · 8	4,5: [SHIFT] ·]
Ä	Upper case A ring	215	#D7	[SHIFT] + [ALT] + 8	4,5: Unshifted [
æ	Lower case diphthong	246	#F6	[ALT] · 9	4: Unshifted [
Æ	Upper case diphthong	214	#D6	[SHIFT] · [ALT] + 9	4: [SHIFT] [
c	Lower case C cedilla	245	#F5	[ALT] ·]	1: [EXTRA] + ½
C	Upper case C cedilla	213	#D5	[SHIFT] · [ALT] ·]	(Same)
ø	Lower case O slash	248	#F8	[ALT] · 0	4: [EXTRA] ·]
Ø	Upper case O slash	216	#D8	[SHIFT] · [ALT] · 0	4: [EXTRA] + ½
ß	German double S	186	#BA	[EXTRA] + S or [EXTRA] + B	2: [EXTRA] ·]
ˆ	Superscript	160	#A0	[EXTRA] · A	(Same)
ˆ	Superscript	161	#A1	[EXTRA] · O	(Same)
Continental textual symbols					
ˆ	Acute accent	179	#B3	[EXTRA] · 6	(Same)
ˆ	Circumflex accent	180	#B4	[EXTRA] · 7	(Same)
ˆ	Grave accent	96	#60	[EXTRA] · 8	5,6: Not set
ˆ	Umlaut	178	#B2	[EXTRA] · 2	1: [EXTRA] · 7: [SHIFT] · [
ˆ	Tilde	126	#7E	[EXTRA] ·]	1: [EXTRA] + 2 2: [EXTRA] + S or · B
“	Open quote (Fr.)	171	#AB	[EXTRA] · \$	5,6: Not set
”	Close quote (Fr.)	172	#AC	[EXTRA] · #	(Same)
¿	Inverted question mark	174	#AE	[EXTRA] ·]	(Same)
¡	Inverted exclam. mark	175	#AF	[EXTRA] ·]	7: Unshifted [
					7: Unshifted [
Direction signs					
→	Up arrow	94	#5E	[EXTRA] · U or [EXTRA] ·]	5: Not set
>	Double shafted right arrow	252	#FC	Not set	
<	Double shafted left arrow	253	#FD	Not set	
<→	Double shafted left right arrow	254	#FE	[EXTRA] · 9	(Same)

I.3 Redefining the keyboard

The CP/M utility that enables the user to redefine the code generated by a particular key or combination of keys is called SETKEYS. It is located on Side 2 of the system discs.

This is only available when you run CP/M. The keystrokes applicable when the PCW8256 is in its word processing mode cannot be changed.

With the help of SETKEYS, you can:

Make a particular key or key combination cause a particular character to appear on the screen.

Make a particular key or key combination give rise to a particular action by the computer, ie take the place of a particular control code or escape sequence.

Make a particular key or key combination equivalent to typing in a particular word, series of words or CP/M command. The required string of characters and/or control codes is known as an Expansion String.

For example, you might like to have an é on your keyboard, accessed through the key combination [EXTRA] + E, or to use the [COPY] key to generate ^ W, the CP/M line editing command that duplicates the previous command line. Another good choice might be to send the instruction DIR *.COM [FULL] [RETURN], thus giving you full details of all the program files on the disc at a stroke.

The permitted key combinations are [SHIFT]+key; [ALT]+key; [EXTRA]+key or [SHIFT]+[ALT]+key. [SHIFT], [ALT] and [EXTRA] are known as the Shift Keys.

The command line that redefines the response of certain keystrokes is SETKEYS *file*, where *file* represents a Key Definition File, which you will have to set up first.

I.3.1 Setting up the key definition file

A key definition file is made up of a sequence of lines, each of which either associates a particular key combination with the chosen end result or sets up an expansion string.

You can find out what the file should look like by listing the KEYS.WP file on Side 2.

The keys themselves are represented by their Key Number, which is fixed for all time: these numbers are shown on the diagram below. The Shift Keys which make up the rest of a key combination are represented by a single letter – S for [SHIFT]; A for [ALT]; and E for [EXTRA].

The combination of both $\overline{\text{SHIFT}}$ and $\overline{\text{ALT}}$ is represented by **SA**. The letters **S**, **A**, **E** and **SA** are used to define the key's Shift State, along with **N** for Normal or Nothing (ie. unshifted).

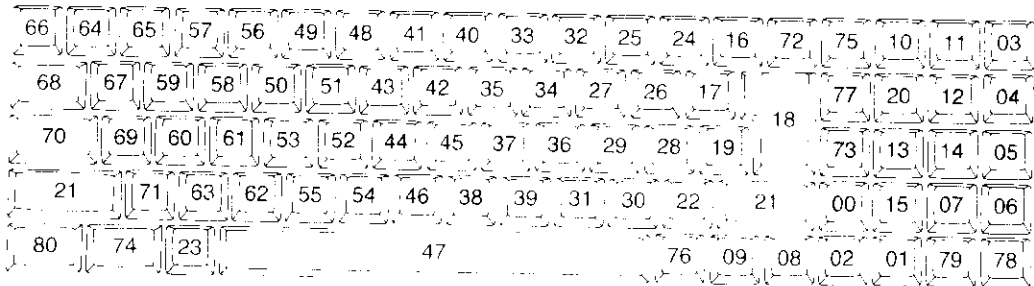

A line of the key definition file that sets up a particular key combination so that it ultimately produces the character currently produced by another key combination takes the form:

key number shift-state "char" [comment]

key-number is the relevant number taken from the above diagram.

shift state is one or more of **N**, **S**, **A**, **E** and **SA**. More than one shift state included here will make the key return the same character in all these shift states. The shift states should be separated by single spaces.

char is the desired character. It is inserted into this line simply by pressing the key that currently produces that character (except for \uparrow and " which for technical reasons have to be inserted as $\uparrow \uparrow$ and $\uparrow \uparrow$).

The optional *comment* is any text that you care to include on the same line to remind you what the line does.

Thus, for example, the line in the key definition file that makes the result of pressing $\overline{\text{SHIFT}}$ + 5 '#' would be:

49 S "" Hash becomes Shift 5

You can also set the key combination to a character which cannot be typed on your keyboard at the moment. You do this by giving its internal code (see the table in section I.4) in the form $\uparrow \uparrow$ 'value' in the above instruction instead of "char". *value* is given as either a decimal or a hexadecimal number.

For instance, to set $\overline{\text{EXTRA}}$ + **E** to return \acute{e} would require the line:

58 E " $\uparrow \uparrow$ 225'" \acute{e} is Extra E or 58 E ""#E1'" \acute{e} is Extra E

(Both $\overline{\text{EXTRA}}$ + **U** and $\overline{\text{EXTRA}}$ + ; are currently set up to produce \uparrow)

You can also redefine the key combinations that are used to generate the CP/M control codes which are currently entered as `[ALT]+letter`.

The entry in the file that does this again starts with the *key-number* and *shift-state* but this time the third element has the form `^letter`

For example, suppose you decided that you would like to have the control code Control-C available through pressing `[ALT]+[ENTER]`; the entry in the file to set this would be:

```
85 A "↑C" Alt + Enter gives Control-C
```

If you want to make a key do nothing, then you set it to the special value 159 or #9F.

The final option is to set a particular combination of keys to return an expansion string, such as a CP/M command that you use often.

What you actually set the key combination to do is to produce a code called an Expansion Token. The computer then looks in a certain area of its memory for the expansion string that has been associated with that token. Expansion tokens take the hexadecimal values #80..#9E (128..158 in decimal)

A number of key combinations have already been set to particular token numbers and the associated expansion string set to either a useful or a dummy set of characters and control codes. In particular, the function keys f1..f8 have been set to return the expansion tokens #81..#88. The current settings are given in the table in section I.3.3.

Setting a key to return an expansion string is a two part operation.

The two lines you will need in the key definition file are:

- a line setting the expansion token accessed by the key combination; and
- a line setting the expansion token to the required string.

These can appear in the key definition file in any order.

If, however, you just want to reset the expansion string associated with a key that has already been set to return an expansion token, all you will need is the line setting the expansion token to the required string.

The line setting which expansion token is returned takes the same form as in the case of setting a key to a particular character via its internal code, ie. *key-number shift-state* "↑'value'". The line giving the expansion string corresponding to that expansion token is:

```
E 'value' "expansion string"
```

The expansion string can contain any combination of characters and control codes (produced as above by typing \uparrow *letter* to represent Control-*letter*). Both the number of characters in an expansion string and the total number of characters used in expansion strings may not go above certain values, but you are unlikely to meet either of these limits.

For example, suppose you would like to run MALLARD BASIC by just pressing [ALT] + [*fr*].

Normally what you would type after the system prompt would be BASIC [RETURN], so what you want as the expansion string would be BASIC \uparrow M (Control-M being the control sequence equivalent to pressing the [RETURN] key). You would therefore have two lines in the key definition file as follows:

```
E #80 "BASIC  $\uparrow$  M"  
02 A "  $\uparrow$  '#80' "
```

You can put all these instructions into a file with the aid of either the supplied BASIC text editor RPED or the CP/M text editor ED, as described in Chapter 2 ('Creating a new file'). With this information in a file, all you need to type is:

```
setkeys file
```

Alternatively, you may wish to use one of the two special key definition files supplied on the PCW8256 system discs to redefine your keyboard. These are KEYS.WP on Side 2, which is designed to suit some industry standard word processors, and KEYS.DRL on Side 4, which is designed to work well with Dr. Logo.

1.3.2 Making the redefined keyboard your standard

If you want to make the key definitions within your file standard as far as your machine is concerned, you can do this with the aid of the PROFILE.SUB file. All that is required is a line in that file that tells the system to run the SETKEYS utility, taking as its source your key definition file.

You will find more about the PROFILE.SUB file in Chapter 2 ('Personalising your system').

I.3.3 The supplied set of expansion tokens and expansion strings

These settings are designed to aid your use of CP/M commands and Mallard BASIC.

Expansion token	Expansion string	Key combination
#80	Control-C	[STOP]
#81	Control-Z	[f ₁]
#82	Control-Z	[f ₂] ([SHIFT] + [f ₁])
#83	Control-Q	[f ₃]
#84	Control-Q	[f ₄] ([SHIFT] + [f ₃])
#85	Control-S	[f ₅]
#86	Control-S	[f ₆] ([SHIFT] + [f ₅])
#87	Control-P	[f ₇]
#88	Control-P	[f ₈] ([SHIFT] + [f ₇])
#89	Control-G	[DEL→]
#8A	Del	←[DEL]
#8B	Control-H	[CAN]
#8C	Control-U	[CUT]
#8D	Control-W	[PASTE]
#8E	Control-]	[FIND]
#8F	Control-F Control-B Control-B	[EOL]
#90	Control-F Control-B	[LINE]
#91	Control- _~	[_~]
#92	Control-V	[_^]
#93	Control-A	[_^]
#94	Control-F	[_^] OR [CHAR]
#95	Control-R	[RELAY]
#96	Control- _~	[_~]
#97	Control-K	[ALT] + [DEL→]
#98	Control-\	[_~]
#99	Control-E	[ALT] + [_~]
#9A	Control-X	[ALT] + [←DEL]

1.4 The complete character set

Decimal value	Hex value	Symbol	Description	Alternative meaning
0	#00	∞	Infinity	Control-(a
1	#01	⊙	Arrow out of page	Control-A
2	#02	Γ	Upper case gamma	Control-B
3	#03	Δ	Upper case delta	Control-C
4	#04	⊗	Arrow into page	Control-D
5	#05	×	Multiply	Control-E
6	#06	÷	Divide	Control-F
7	#07	∴	Therefore	Control-G
8	#08	Π	Upper case pi	Control-H
9	#09	↓	Down pointing arrow	Control-I
10	#0A	Σ	Upper case sigma	Control-J
11	#0B	←	Left pointing arrow	Control-K
12	#0C	→	Right pointing arrow	Control-L
13	#0D	±	Plus or minus	Control-M
14	#0E	↔	Arrow pointing left/right	Control-N
15	#0F	Ω	Upper case omega	Control-O
16	#10	α	Lower case alpha	Control-P
17	#11	β	Lower case beta	Control-Q
18	#12	γ	Lower case gamma	Control-R
19	#13	δ	Lower case delta	Control-S
20	#14	ε	Lower case epsilon	Control-T
21	#15	θ	Lower case theta	Control-U
22	#16	λ	Lower case lambda	Control-V
23	#17	μ	Lower case mu	Control-W
24	#18	π	Lower case pi	Control-X
25	#19	ρ	Lower case rho	Control-Y
26	#1A	σ	Lower case sigma	Control-Z
27	#1B	τ	Lower case tau	Control-[
28	#1C	φ	Lower case phi	Control-\
29	#1D	χ	Lower case chi	Control-]
30	#1E	ψ	Lower case psi	Control-↑
31	#1F	ω	Lower case omega	Control-~
32	#20		Space	
33	#21	!	Exclamation mark	
34	#22	"	Double quote	
35	#23	#	Hash	
36	#24	\$	Dollar	
37	#25	%	Per cent	

Decimal value	Hex value	Symbol	Description	Alternative meaning
38	#26	&	Ampersand	
39	#27	'	Apostrophe	
40	#28	(Open parentheses	
41	#29)	Close parenthesis	
42	#2A	*	Asterisk	
43	#2B	+	Plus	
44	#2C	,	Comma	
45	#2D	-	Minus	
46	#2E	.	Full stop	
47	#2F	/	Slash	
48	#30	0	Zero	
49	#31	1	One	
50	#32	2	Two	
51	#33	3	Three	
52	#34	4	Four	
53	#35	5	Five	
54	#36	6	Six	
55	#37	7	Seven	
56	#38	8	Eight	
57	#39	9	Nine	
58	#3A	:	Colon	
59	#3B	;	Semicolon	
60	#3C	<	Less than sign	
61	#3D	=	Equals sign	
62	#3E	>	Greater than sign	
63	#3F	?	Questionmark	
64	#40	@	At	
65	#41	A	Upper case A	
66	#42	B	Upper case B	
67	#43	C	Upper case C	
68	#44	D	Upper case D	
69	#45	E	Upper case E	
70	#46	F	Upper case F	
71	#47	G	Upper case G	
72	#48	H	Upper case H	
73	#49	I	Upper case I	
74	#4A	J	Upper case J	
75	#4B	K	Upper case K	
76	#4C	L	Upper case L	
77	#4D	M	Upper case M	
78	#4E	N	Upper case N	

Decimal value	Hex value	Symbol	Description	Alternative meaning
79	#4F	O	Upper case O	
80	#50	P	Upper case P	
81	#51	Q	Upper case Q	
82	#52	R	Upper case R	
83	#53	S	Upper case S	
84	#54	T	Upper case T	
85	#55	U	Upper case U	
86	#56	V	Upper case V	
87	#57	W	Upper case W	
88	#58	X	Upper case X	
89	#59	Y	Upper case Y	
90	#5A	Z	Upper case Z	
91	#5B	[Open square bracket	
92	#5C	\	Backslash	
93	#5D]	Close square bracket	
94	#5E	·	Up arrow	
95	#5F	_	Underline	
96	#60	`	grave accent	
97	#61	a	Lower case A	
98	#62	b	Lower case B	
99	#63	c	Lower case C	
100	#64	d	Lower case D	
101	#65	e	Lower case E	
102	#66	f	Lower case F	
103	#67	g	Lower case G	
104	#68	h	Lower case H	
105	#69	i	Lower case I	
106	#6A	j	Lower case J	
107	#6B	k	Lower case K	
108	#6C	l	Lower case L	
109	#6D	m	Lower case M	
110	#6E	n	Lower case N	
111	#6F	o	Lower case O	
112	#70	p	Lower case P	
113	#71	q	Lower case Q	
114	#72	r	Lower case R	
115	#73	s	Lower case S	
116	#74	t	Lower case T	
117	#75	u	Lower case U	
118	#76	v	Lower case V	
119	#77	w	Lower case W	

Decimal value	Hex value	Symbol	Description	Alternative meaning
120	#78	x	Lower case X	
121	#79	y	Lower case Y	
122	#7A	z	Lower case Z	
123	#7B	{	Open curly bracket	
124	#7C		Vertical bar	
125	#7D	}	Close curly bracket	
126	#7E	~	Tilde	
127	#7F	0	Zero without a slash	DEL
128-159	#80-#9F		Graphics (see below)	Expansion tokens
128-135	#80-#87	▀ ▁ ▂ ▃ ▄ ▅ ▆ ▇		
136-143	#88-#8F	█ ▉ ▊ ▋ ▌ ▍ ▎ ▏		
144-151	#90-#97	▐ ░ ▒ ▓ ▔ ▕ ▖ ▗		
152-159	#98-#9F	▘ ▙ ▚ ▛ ▜ ▝ ▞ ▟		
160	#A0	[◌]	Superscript ◌	
161	#A1	◦	Superscript ◦	
162	#A2	°	Degree	
163	#A3	£	Pound sign	
164	#A4	©	Copyright	
165	#A5	¶	Paragraph sign	
166	#A6	§	Section	
167	#A7	†	Dagger	
168	#A8	¼	One quarter	
169	#A9	½	Half	
170	#AA	¾	Three quarters	
171	#AB	«	Open quotes (Fr.)	
172	#AC	»	Close quotes (Fr.)	
173	#AD	Pt	Peseta	
174	#AE	¿	Inverted question mark	
175	#AF	¡	Inverted exclamation mark	
176	#B0	f	Florin	
177	#B1	c	Cent	
178	#B2	¨	Umlaut	
179	#B3	´	Acute accent	
180	#B4	ˆ	Circumflex	
181	#B5	‰	Per thousandth	
182	#B6	⅛	One eighth	

Decimal value	Hex value	Symbol	Description	Alternative meaning
183	#B7	⅜	Three eighths	
184	#B8	⅝	Five eighths	
185	#B9	⅞	Seven eighths	
186	#BA	ß	German double S	
187	#BB	○	Open circle	
188	#BC	●	Bullet	
189	#BD	¥	Yen	
190	#BE	®	Registered mark	
191	#BF	™	Trade mark	
192	#C0	Ā	Upper case A acute	
193	#C1	É	Upper case E acute	
194	#C2	Í	Upper case I acute	
195	#C3	Ó	Upper case O acute	
196	#C4	Ú	Upper case U acute	
197	#C5	Ă	Upper case A circumflex	
198	#C6	Ê	Upper case E circumflex	
199	#C7	Î	Upper case I circumflex	
200	#C8	Ô	Upper case O circumflex	
201	#C9	Û	Upper case U circumflex	
202	#CA	Ä	Upper case A grave	
203	#CB	È	Upper case E grave	
204	#CC	Ì	Upper case I grave	
205	#CD	Ò	Upper case O grave	
206	#CE	Û	Upper case U grave	
207	#CF	ÿ	Upper case Y umlaut	
208	#D0	Ä	Upper case A umlaut	
209	#D1	Ë	Upper case E umlaut	
210	#D2	Ï	Upper case I umlaut	
211	#D3	Ö	Upper case O umlaut	
212	#D4	Ü	Upper case U umlaut	
213	#D5	Ç	Upper case C cedilla	
214	#D6	Æ	Upper case diphthong	
215	#D7	Å	Upper case A ring	
216	#D8	Ø	Upper case O slash	
217	#D9	Ñ	Upper case N tilde	
218	#DA	Ã	Upper case A tilde	
219	#DB	Õ	Upper case O tilde	
220	#DC	≥	Greater than or equal	
221	#DD	≤	Less than or equal	
222	#DE	≠	Not equal	
223	#DF	≈	Approximately equal	

Decimal value	Hex value	Symbol	Description	Alternative meaning
224	#E0	á	Lower case A acute	
225	#E1	é	Lower case E acute	
226	#E2	í	Lower case I acute	
227	#E3	ó	Lower case O acute	
228	#E4	ù	Lower case U acute	
229	#E5	â	Lower case A circumflex	
230	#E6	ê	Lower case E circumflex	
231	#E7	î	Lower case I circumflex	
232	#E8	ô	Lower case O circumflex	
233	#E9	û	Lower case U circumflex	
234	#EA	à	Lower case A grave	
235	#EB	è	Lower case E grave	
236	#EC	ì	Lower case I grave	
237	#ED	ò	Lower case O grave	
238	#EE	ù	Lower case U grave	
239	#EF	ÿ	Lower case Y umlaut	
240	#F0	ä	Lower case A umlaut	
241	#F1	ë	Lower case E umlaut	
242	#F2	ï	Lower case I umlaut	
243	#F3	ö	Lower case O umlaut	
244	#F4	ü	Lower case U umlaut	
245	#F5	ç	Lower case C cedilla	
246	#F6	æ	Lower case diphthong	
247	#F7	à	Lower case A ring	
248	#F8	ø	Lower case O slash	
249	#F9	ñ	Lower case N tilde	
250	#FA	ã	Lower case A tilde	
251	#FB	õ	Lower case O tilde	
252	#FC	=>	Double shafted arrow pointing right	
253	#FD	<=	Double shafted arrow pointing left	
254	#FE	<->	Double shafted arrow left/right	
255	#FF	=	Equivalent	

Appendix II

Advanced use of the printer

Elsewhere in this manual, we have described how to set the printer up to handle different types of paper (see section 2.13) and introduced some of the actions possible when the PCW8256 is in Printer Control State.

Here, we describe the Printer Control State in more detail and then how to access special printer features such as different typestyles and graphics.

II.1 The Printer Control State

The actions that become possible when the PCW8256 is in its Printer Control State are broadly those commonly provided by buttons on other dot matrix printers, ie switching between On-line (ready to print) and Off-line (halted), executing additional line feeds and form feeds, and changing between Draft quality and High quality printing.

The PCW8256 is put into its Printer Control State either when you press the `[PTR]` key or when you turn the Paper Load Knob on the printer a quarter of a turn towards you to start the automatic paper feed process. The computer also puts itself into Printer Control State if you try to print something while it is waiting for paper.

If the printer is in the middle of printing out some text when you press the `[PTR]` key, it will halt as soon as it has finished either printing the current line or moving the paper to the next print position.

The operations that can be carried out in this state are now indicated on the bottom line of your screen. This line is divided into either seven or eight separate 'buttons' by vertical bars. These buttons are 'pressed' by moving the cursor to the button and then pressing the `[^]` or `[_]` key.

Each button either tells you about the current state of the printer or outlines an operation. The precise combination depends on what state the printer is in.

The first button displays the current state of the printer. The possible messages are:

Active	The printer is finishing its current operation.
Online	The printer is ready to print when you leave Printer Control. Press [] to put the printer Offline.
Offline	The printer is halted. Press [] to put the printer Online
Bail bar out	After loading paper, before bail bar is replaced.
Waiting for paper	The printer has just printed a page and is waiting for the next sheet to be loaded. Loading this sheet will change the printer state to Online. If this message is given while you are using continuous stationery, this indicates that you haven't set the printer to handle continuous stationery. You should now use the PAPER utility to put this right: however, pressing [] will temporarily clear the problem and allow you to continue printing.
Out of paper	There is no paper in the printer.
Error	Hardware error detected. RESET will clear this state.
No printer	The printer is not connected. Check both the power and the ribbon connections, and then move to the RESET button and press the [] key. If the No printer message is not cleared, either the printer or the PCW8256 is faulty.

The next button only appears if the printer is either On-line or Off-line. The message will be either at Line: *n* or Top of Form. This gives the current position of the paper as a number of lines of text (*n*) printed with a line spacing of 1/6in. If the message is Top of Form, this means Line 1 on continuous stationery but Line 7 on single sheet stationery.

You can change the physical position of the Top of Form to the current print position by pressing [] when the cursor is over this part of the line. The printer will redefine Line 1 (continuous stationery) or Line 7 (single sheet stationery) as this new position.

LF and FF The next two buttons will be LF (for Line Feed) and FF (for Form Feed), provided these operations are valid. Otherwise these will be blank. Move the cursor to the relevant button and press [] to get the required action.

Print quality The next button indicates whether the printer output is currently High Quality or Draft Quality. In High Quality, the characters are better formed, making it highly suitable for business letters and other formal documentation. The advantage of Draft Quality is that it is quick.

Press either the [] or the [] key to swop between these two print qualities.

Paper end detection The next button indicates whether the signal from the paper end detector can halt printing. If the message is P0 Defeat:On, the signal from this detector is ignored; if it is P0 Defeat:Off, the printer will stop when it gets to within 1/2in of the bottom of the current sheet of paper.

Typically, you would set P0 Defeat:On when using single sheet stationery and P0 Defeat:Off when using continuous stationery.

Press either the [·] or the [] key to swop between these two states.

Printing hexadecimal codes The next button is set to Hex-Dump:On if you want everything that is sent to the printer, printed as its internal hexadecimal code. This option is most useful when you are debugging a program. The more usual state is Hex-Dump:Off.

Press either the [·] or the [] key to swop between these two states.

The final button contains the word RESET. Pressing the [·] key when the cursor is over this part of the line causes all the printer parameters to be set back to their current default values. Any text waiting to be printed is lost.

The initial default values are:

Line Pitch	6 lines per inch
Form Length	70 lines
Gap Length	3 lines
Single Sheet stationery	
Paper Out Defeat	ON

These can be changed through use of the Defaults option of the PAPER utility (see Chapter 5).

Resetting the printer should clear any printer operation errors.

Leave Printer Control State by pressing [EXIT]

II.2 Further control of the printer

The only time when you will need to know how to control the printer to any greater degree will be either when you are installing some software you have just bought or when you need to use the special printer features to enhance the output your program produces.

The printer supplied with the PCW8256 works very much like any other dot matrix printer. The special features are made available by sending particular sequences of characters called Printer Control Codes to the printer. These codes are very similar to those used by the Seikosha SP-800 and Epson FX-80 printers.

The codes that control the features of the PCW8256 printer are listed below, grouped according to the type of effect they have. The groupings are:

- Page layout
- Print position changes
- Printer initialisation
- Typestyles
- Special characters
- Graphic effects

II.2.1 Printer control codes

Most of the codes are referred to as Escape codes. These start with the special character ESC. This has an internal code represented by #1B in the hexadecimal notation or 27 in decimal.

The next element in the sequence is a single printable character, which then may be followed by one or more Parameters. These parameters are given here by their internal decimal codes, represented either by the number itself or by *n*. If you have a choice whether one or many of these decimal values are specified, this is shown by [*n*]

The notes accompanying each code give further details of the code, where these are appropriate. In particular, these notes include the range of values *n* may take.

For example, the printer control code given here as ESC 0 tells you that the sequence of character codes that the printer requires is the internal code for ESC followed by the internal code for 0

Similarly, the printer control code given as ESC l *n* means that the printer requires the internal code for ESC, followed by the internal code for l, followed by the internal code *n*, whatever you choose *n* to be.

Other codes use further special characters such as CR and FF. The corresponding internal decimal code is given in parentheses alongside such a code.

The way you treat these codes depends on the type of program you are working with.

If you want to control the printer from a Mallard BASIC program, then the codes given here would be used in a LPRINT statement. ESC is replaced by CHR\$(27), each printable character is represented by a string made up of the character itself surrounded by double inverted commas and the decimal values are given as CHR\$(*n*).

For example, the code that sets the line spacing to eight lines per inch is ESC 0. So the LPRINT statement to be used here is:

```
LPRINT CHR$(27);"0";
```

On the other hand, the code that sets the left hand margin is ESC L *n* and the notes tell you that, in normal text, *n* can take any value between 0 and 78. Say you would like the margin to be 10 characters in, then the full code you want is ESC L 10 and the corresponding LPRINT statement would be:

```
LPRINT CHR$(27);"L";CHR$(10)
```

If you want to use the codes here to set up the printer definition file used by the SETLST utility, then ESC is replaced by '^ESC', the single characters remain as themselves and the decimal values are given as '^*n*'.

So the string needed to set the line spacing to eight lines per inch (ESC 0) is:

```
^ESC'0
```

while that needed to put the left hand margin 10 characters in (ESC L 10) is:

```
^ESC'L'10'
```

II.2.2 Printing text

The printer is normally used to print text and it can do this in a number of typestyles.

The printer generates its various different typestyles by changing the number of characters it prints per inch (the Pitch), slanting them and/or printing them more than once to produce such effects as Bold (Emphasised) or Double-strike text.

Four pitches are available on the PCW8256's printer. These are known as Pica, Elite, Condensed and Proportionally Spaced. Pica is 10 characters per inch (cpi), Elite is 12cpi and Condensed is approximately 17cpi. The Proportionally Spaced setting prints each character in a suitable space for the width of that character, so an i would take less space than a w. On average, Proportionally Spaced text has around 12cpi.

Each of these pitches can be Enlarged. The effect of this is to double the width of the characters and so halve the number of characters per inch.

Slanting (or Italic) characters can be generated in all these pitches as can the Double-strike effect, but for technical reasons the Bold effect cannot be used with Condensed text. It should also be noted that superscripts and subscripts will not have the Double-strike quality of surrounding characters.

Another option is High Quality text, in which the characters appear better formed. However, this quality of text is not available either for 17cpi characters or for superscripts and subscripts. In addition, there is no Double-strike option with High Quality text.

These exclusions are summarised as follows:

- High Quality is not possible in Condensed text or on superscripts and subscripts
- Double-strike is not available in High Quality text or on superscripts and subscripts
- Bold is not available in Condensed text

However, Bold will be substituted for Double-strike and vice versa if possible.

II.2.3 Printing graphics

The PCW8256's printer can also be used to display graphics.

Any picture that is printed is made up of rows of dots and gaps. Each dot or gap is known as a Pixel. So the first step is to translate the image you want to create into a pattern of dots and spaces.

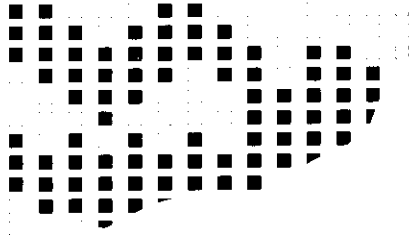

The next step is to translate the pattern of dots and spaces into numbers. These numbers will form your data when it comes to printing the image. To do this, the pixels are first grouped into eights as shown here.

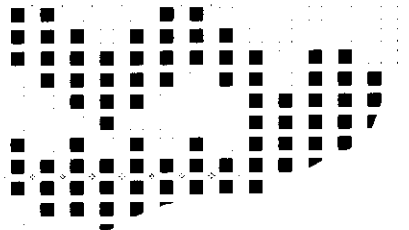

Each group of eight pixels is known as a Bit Image.

Starting at the top left hand corner, each bit image is taken in turn and converted into an 8bit number by putting a 1 for each dot and a 0 for each space. The pixel at the top of the group sets the value of the most significant bit.

For example, the image we show here would start:

```
11100011
11110001
01111011
```

These 8bit numbers are usually expressed as their hexadecimal equivalents. This is certainly the case if the LPRINT statement of a Mallard BASIC program will be used to send the image to the printer. These numbers are known as the Bit Image Data.

There are two graphics modes on the PCW8256 printer – Normal density and Dual density. In normal density, the printed image has a maximum of 480 bit images across the page corresponding to 60 dots per inch. 480 is therefore the biggest number of pixels your image can have across one line. In dual density, these figures change to 960 and 120 respectively.

The codes needed by the printer to generate the image for you are given in section II.8

Graphics data cannot be printed beyond the right margin, so remember to check that the settings of the margins are correct for the image you want to print. Any excess image data will be lost.

In either mode the vertical dot spacing is $1/72$ in. To get the whole picture without white lines across the middle of it or overlapping between the lines, you will have to remember to set the line spacing to $8/72$ in.

II.3 Page layout

Line spacing

Lines 1/8in apart (8 lines per inch)	ESC 0	
Lines 7/12in apart (approx 10 lines per inch)	ESC 1	
Lines 1/8in apart (6 lines per inch)	ESC 2	
Lines $n/216$ in apart	ESC 3 n	$n = 0..255$
Lines $n/72$ in apart	ESC A n	$n = 0..85$

Default setting: Lines 1/6in apart (6 lines per inch).

Margins

Set left margin	ESC I n
Set right margin	ESC Q n

n gives the position of the margin in terms of the equivalent number of characters in the current typestyle.

Constraints on margin settings

Pica text (10cpi)	Left margin	$n = 0..78$
	Right margin	$n = 2..81$
Condensed text (17cpi)	Left margin	$n = 0..133$
	Right margin	$n = 4..139$
Elite text (12cpi)	Left margin	$n = 0..93$
	Right margin	$n = 3..96$
Enlarged text (5cpi)	Left margin	$n = 0..39$
	Right margin	$n = 1..40$
Enlarged condensed (8.5cpi)	Left margin	$n = 0..66$
	Right margin	$n = 2..69$
Enlarged elite (6cpi)	Left margin	$n = 0..46$
	Right margin	$n = 2..48$
Proportionally Spaced text	Behaves as Elite text	

The left margin must be more than 1/5in to the left of the right margin. Any illegal settings are ignored.

Default settings:	Left margin	0;	Right margin	80	(Pica)
		0		137	(Condensed)
		0		96	(Elite)
		0		40	(Enlarged)
		0		68	(Enlarged condensed)
		0		48	(Enlarged elite)

Nothing can be printed beyond the right margin. Attempts to do this, merely cause a carriage return to the left margin followed by a single line feed.

Changing the left margin automatically resets the tab stops to every eighth column.

Tabs

Set horizontal tabs

ESC D *[n]* 0

n is the required column number for the tab stop, taking the column immediately to the right of the left margin as zero. No more than 32 tab stops may be set and the column numbers must be given in ascending order.

Each time you use ESC D, you should set all the tab stops you require. The previous settings are automatically erased.

Changing the left margin automatically resets the tab stops to every eighth column – the default setting.

Execute a horizontal tab

HT (9)

The default setting of the tabs is at every eighth column **in all typstyles**.

Tabbing when the next tab position is beyond the right margin causes an automatic carriage return-line feed, taking the printhead to the left margin of the following line.

When the print position is already at or beyond the highest tab position set, the tab code has no effect.

Override paper end detection

Set override	ESC 8
Re-select paper end detection	ESC 9

Paper feed

Advance the paper a specified distance	ESC J <i>n</i>	<i>n</i> - 0..255
--	----------------	-------------------

The distance moved will be $n/216$ in.

Page length

Set in terms of lines of the current spacing	ESC C <i>n</i>	<i>n</i> - 1..127
Set in terms of inches	ESC C 0 <i>n</i>	<i>n</i> - 1..22

The page length is stored as an absolute length. It does not change when the line spacing changes, although this changes the number of lines on the page.

This code also resets the printer to its Top of Form position and cancels any previously set Gap (see below).

Single sheet mode

Select single sheet mode	ESC \$
Select continuous mode	ESC c

In single sheet mode, the printer will wait at the end of each page for a new sheet of paper to be inserted.

Each page starts one inch below the top edge of the sheet.

Skip over lines at bottom of page

Set number of lines to be skipped over	ESC N <i>n</i>	<i>n</i> - 1..127
Cancel previous skip over instruction	ESC O	

The bottom *n* lines of the page are left blank. The number of lines left is usually known as the Gap.

The number of lines skipped over is also returned to zero by setting the page length (ESC C).

II.5 Printer initialisation

Clear print buffer

Clear buffer CAN (24)

Erases all the data stored in the print buffer since the last CR, LF, FF or BS.

Reset the printer

Reset the printer ESC @

The printer returned to its default state, ie. either:

- Pica text (10cpi); not enlarged, not condensed, not elite not italic, not emphasised, not double-strike, not superscript, not subscript, not underlined, not proportionally spaced, not High Quality, zero without a slash, no special characters
- Left margin column 0; right margin column 80; tabs every eight columns
- Line spacing 1/6in; page length 70 lines, gap 3 lines, no automatic line feed
- Single sheet mode, paper end not detected
- UK ASCII character set; only standard characters printable

or: the state last stored by an ESC d command (see below).

Reset the printer defaults

Make the current settings of the relevant parameters the default settings. ESC d

The parameters affected are:

- The Pitch (enlarged or not)
- The Emphasis state (including underlining)
- Upright or italic characters
- High or Draft quality printing
- Left and right margin settings
- Line spacing
- Automatic line feed on/off
- Page length
- Gap at the bottom of the page
- Single sheet or continuous paper
- Paper end detection on/off
- Zero with or without a slash
- The nationality of the ASCII character set

The default tab settings cannot be changed.

The default state may never define the extended character set or hex dumping.

II.6 Typestyles

Condensed text

Change to the Condensed typestyle	SI	(15)
	or	ESC SI
Return to Pica (10cpi) text	DC2	(18)

The standard Condensed face is approximately 17cpi; when enlarged, this becomes approximately 8.5cpi.

Elite text

Change to the Elite typestyle	ESC M
Return to Pica (10cpi) text	ESC P

The standard Elite face has 12cpi; when enlarged this becomes 6cpi.

Proportionally spaced text

Set proportional spacing	ESC p 1
Return to Pica (10cpi) text	ESC p 0

The standard proportionally spaced text has roughly 12cpi; when enlarged, this becomes approximately 6cpi.

Enlarged text

Change to the enlarged version of the current typestyle	SO	(14)
	or	ESC SO
	or	ESC W 1
Cancel a previous instruction to enlarge	DC4	(20)
	or	ESC W 0

With the Enlarged typestyle selected, the width of every character is doubled. Pica text is therefore printed at 5cpi, Elite text at 6cpi, Condensed text at approximately 8.5cpi and Proportionally spaced text at about 6cpi.

If the Enlarge option is selected using either SO or ESC SO, the characters will automatically return to their normal pitch after the next line feed (LF) or form feed (FF). This is not the case if ESC W 1 was used.

DC4 will not cancel ESC W 1.

Italic text

Change to the italic character set	ESC 4
Change back to the normal character set	ESC 5

Italic characters may also be generated by setting bit 7 on the character.

High Quality text

Change to High Quality text	or	ESC m 1
Change back to Draft quality	or	ESC x 1
		ESC m 0
		ESC x 0

High Quality is not available for Condensed text
for Superscripts and subscripts
with Double-strike

Double-strike

Select double-strike	ESC G
Cancel previous double-strike instruction	ESC H

In Double-strike, the data is printed twice, the second time with the paper advanced by 1/144in. This improves the visual quality of the characters.

The Double-strike effect is not available on superscripts and subscripts, or with High Quality text.

Emphasised (bold) text

Select emphasised printing	ESC E
Cancel previous emphasise instruction	ESC F

The emphasised effect comes from printing a shadow of the character 1/120in to the right (1/144in when using Elite or Proportionally spaced text).

Selecting a mixed print mode

Select mode ESC ! *n* *n* - 0..63

Each value of *n* corresponds to a particular combination of Enlarged mode, Double-strike mode, Emphasised mode, Condensed text, Elite text and Pica text.

The decimal numbers correspond to 5bit numbers, the most significant bit of which sets Enlarged; the next Double-strike; the next Emphasised (Bold); the next Condensed; and the last Elite.

The usual restrictions apply. So if you request Bold and Condensed, you will get Double-strike and Condensed.

The effect displayed is also affected by the selection of Draft or High quality printing and by the printing of superscripts and subscripts. Superscripts and subscripts are always printed in draft quality and are printed bold rather than double-strike.

Setting a mixed print mode overrides any previous settings of Pica, Elite, Condensed, Enlarged, Emphasised and Double-strike.

Superscripts and subscripts

Set superscript	ESC S 0
Set subscript	ESC S 1
Cancel either superscript or subscript	ESC T

Superscripts are set in the upper half of the line; subscripts in the lower half.

Both superscripts and subscripts are printed using two passes of the print head.

Superscripts and subscripts are not affected by the selection of either Double-strike or High Quality printing.

Underline

Set underline function	ESC 1
Cancel underlining	ESC 0

II.7 Special characters

Character set variants

Change to a specified national character set

ESC R *n*

n=0..8

The character set identifiers are as follows:

<i>n</i> =0	US
1	French
2	German
3	UK
4	Danish
5	Swedish
6	Italian
7	Spanish
8	Japanese

The initial default character set is UK.

HEX	DEC	USA	FRANCE	GERMANY	UK	DENMARK	SWEDEN	ITALY	SPAIN	JAPAN
23H	35	# #	# #	# #	# #	# #	# #	# #	# R	# #
24H	36	# \$	# \$	# \$	# \$	# \$	# \$	# \$	# \$	# \$
40H	64	@ @	@ @	@ @	@ @	@ @	@ @	@ @	@ @	@ @
5BH	91	[[[[[[[[[
5CH	92	\	\	\	\	\	\	\	\	\
5DH	93]]]]]]]]]
5EH	94	^	^	^	^	^	^	^	^	^
60H	96	~	~	~	~	~	~	~	~	~
7BH	123	{	{	{	{	{	{	{	{	{
7CH	124									
7DH	125	}	}	}	}	}	}	}	}	}
7EH	126	~	~	~	~	~	~	~	~	~

Extending the range of characters that can be printed

Adding the characters with decimal values between 0..31 and 128..159 that do not correspond to valid control codes

ESC I 1

Cancelling a previous ESC I 1 instruction

ESC I 0

The characters available following a ESC I I instruction are shown in the table below.

HEX	DEC		HEX	DEC		HEX	DEC		HEX	DEC	
00H	0	␣	10H	16	␣	80H	128	␣	90H	144	␣
01H	1	␣	11H	17	␣	81H	129	␣	91H	145	␣
02H	2	␣	12H	18	DC2	82H	130	␣	92H	146	DC2
03H	3	␣	13H	19	␣	83H	131	␣	93H	147	␣
04H	4	␣	14H	20	DC4	84H	132	␣	94H	148	DC4
05H	5	␣	15H	21	␣	85H	133	␣	95H	149	␣
06H	6	␣	16H	22	␣	86H	134	␣	96H	150	␣
07H	7	BEL	17H	23	␣	87H	135	BEL	97H	151	␣
08H	8	BS	18H	24	CAN	88H	136	BS	98H	152	CAN
09H	9	HT	19H	25	␣	89H	137	HT	99H	153	␣
0AH	10	LF	1AH	26	␣	8AH	138	LF	9AH	154	␣
0BH	11	VT	1BH	27	ESC	8BH	139	VT	9BH	155	ESC
0CH	12	FF	1CH	28	␣	8CH	140	FF	9CH	156	␣
0DH	13	CR	1DH	29	␣	8DH	141	CR	9DH	157	␣
0EH	14	SO	1EH	30	␣	8EH	142	SO	9EH	158	␣
0FH	15	SI	1FH	31	␣	8FH	143	SI	9FH	159	␣

Selecting zero with or without a slash

Set zero with a slash

ESC X

Set zero without a slash

ESC o

II.8 Graphic effects

Dual density bit images

Set dual density

ESC L $n1\ n2$ } followed
or ESC * 1 $n1\ n2$ } by data

The number of bit images to be printed in the line (ie the number of data characters in your command) is specified by $n1$ and $n2$. $n1$ is the required number MOD 256 and $n2$ is the result of the integer division of the required number by 256.

For example, suppose the required number of bit images is 300. $n1$ would be 300 MOD 256 which is 44; $n2$ would be 300\256 which is 1.

The alternative way of looking at $n1$ and $n2$ is as the the least significant byte and the most significant byte of the 16 bit number that specifies how many data characters you have.

The generation of the bit image data is explained on section II.3

The maximum number of images on any line is 960 in dual density. If text and bit image data are to be mixed on the same line, then each Pica character corresponds to 12 bit image positions, each Elite character corresponds to 10, each Condensed character to 7, each Enlarged Pica to 24, each Enlarged Elite to 20 and each Enlarged Condensed character to 14 bit image positions.

Once the bit image line has been completed, the printer automatically returns to its current text mode.

Graphics data cannot be printed beyond the right margin. Any excess is lost.

Normal density bit images

Set normal density

ESC K $n1\ n2$ } followed
or ESC * 0 $n1\ n2$ } by data

The number of bit images to be printed in the line (ie. the number of data characters in your command) is specified by $n1$ and $n2$. $n1$ is the required number MOD 256 and $n2$ is the result of the integer division of the required number by 256.

For example, suppose the required number of bit images is 300. $n1$ would be 300 MOD 256 which is 44; $n2$ would be 300\256 which is 1.

The alternative way of looking at $n1$ and $n2$ is as the the least significant byte and the most significant byte of the 16 bit number that specifies how many data characters you have.

The generation of bit image data is explained in section II.3

The maximum number of images on any line is 480 in normal density. If text and bit image data are to be mixed on the same line, then each Pica character corresponds to 6 bit image positions, each Elite character corresponds to 5, each Condensed character to 3, each Enlarged to 12, each Enlarged Elite to 10 and each Enlarged Condensed character to 7 bit image positions.

Once the bit image line has been completed, the printer automatically returns to its current text mode.

Graphics data cannot be printed beyond the right margin. Any excess will be lost.

Appendix III

Terminal characteristics

The CP/M Plus implementation on the PCW8256 includes a Terminal Emulator which provides facilities very similar to those of a Zenith Z19/Z29 monitor. This makes the PCW8256 screen one of the many to broadly emulate a VT52 terminal.

The terminal emulator is provided as part of the CRT physical device. This is normally attached to the CONOUT: logical device. (See the description of the DEVICE command in chapter 5, for further details of CP/M devices.)

Use of the screen is limited to a viewport which may be all or part of the screen. The size and shape of the viewport is changed either through the ESC X sequence described below, or by selecting 24 x 80 mode or by enabling/disabling the status line.

Row and column numbers should be given relative to the top left-hand corner of the viewport, with the exception of the row and column numbers needed to set a new viewport. These should be given relative to the top left-hand corner of the screen.

Operations that erase text, only affect characters within the current viewport. However, scrolling the viewport can affect text outside the present viewport.

The full details of the way text is handled on the screen are as follows:

Characters with internal codes in the range 32..255 (#20..#FF in the hexadecimal notation) are displayed on the screen at the current cursor position.

Generally the cursor is then moved right by one column. However, if the cursor is at the column furthest to the right and wrapping is enabled, it will move to the column furthest to the left on the next line, the screen scrolling up if necessary. If wrapping is not enabled, the final character on the line will be overwritten.

Characters with internal codes in the range 0..31 (#00..#1F) are interpreted as control codes as follows:

7 #07	BEL (Bell)	Sounds a bleep.
8 #08	BS (Backspace)	Moves the cursor one column to the left. If the cursor is at the column furthest to the left and wrapping is enabled, it is moved to the column furthest to the right on the row above - unless it is already on the top row.

10 #0A	LF (Line feed)	Moves the cursor down one line, scrolling the screen up if necessary.
13 #0D	CR (Carriage return)	Moves the cursor to the column furthest to the left on the present row.
27 #1B	ESC (Escape)	Introduces an Escape sequence or a literal character.

All other control codes are ignored.

The following Escape sequences are interpreted as follows:

ESC 0	Disables the status line. The CRT may then use the bottom line of the screen. Disc system messages will appear with the CRT output.
ESC 1	Enables the status line. Disc system messages will appear on the bottom line of the screen.
ESC 2 <i>n</i>	Changes the character set to one of the national variants (see Appendix I)
ESC 3 <i>m</i>	Changes the screen mode. This is provided for compatibility with other Amstrad computers and is not recommended for normal use.
ESC A	Moves the cursor up. If the cursor is already on the top row, it has no effect.
ESC B	Moves the cursor down. If the cursor is already on the bottom row, it has no effect.
ESC C	Moves the cursor right one column. If the cursor is already at the column furthest to the right, it has no effect.
ESC D	Moves the cursor left one column. If the cursor is already at the column furthest to the left, it has no effect.
ESC E	Clears the viewport. The position of the cursor is unaffected.
ESC H	Moves the cursor to its Home position, ie row 0, column 0 – the top left-hand corner.
ESC I	(Reverse index) Moves the cursor up one row. The page is scrolled down if necessary.
ESC J	Erases to the end of the page, including the character at the cursor position. The cursor position is unaffected.
ESC K	Erases to the end of the line, including the character at the cursor position. The cursor position is unaffected.
ESC L	Inserts a line. The row with the cursor on it and all rows below are scrolled down one line. The cursor row is cleared. The position of the cursor is unaffected.
ESC M	Deletes the line with the cursor on it. All rows below are scrolled up one line. The bottom row is cleared. The cursor position is unaffected.
ESC N	Deletes the character under the cursor. All the characters to the right of the cursor are shuffled one column to the left. The character at the end of the row is cleared. The cursor position is unaffected.

ESC X <i>tr lc h w</i>	Sets the text viewport. <i>t</i> is the row number of the top of the view port plus 32 (#20); <i>lc</i> is the column number of the left hand edge of the viewport plus 32 (#20); <i>h</i> is the number of rows in the viewport (ie its height) minus 1 plus 32 (#20); <i>w</i> is the number of column in the viewport (ie its width) minus 1 plus 32 (#20). The cursor is moved if necessary to a position within the viewport.
ESC Y <i>r c</i>	Moves the cursor to a given position. <i>r</i> is the row number plus 32 (#20); <i>c</i> is the column number plus 32 (#20). If the position is beyond the edge of the viewport, the cursor is moved to the edge of the viewport.
ESC b <i>c</i>	Sets the foreground colour. For compatibility with other Amstrad computers, set <i>c</i> to either 63 (#3F) or 0 (#00). 63 corresponds to bright; 0 to dark.
ESC c <i>c</i>	Sets the background colour. For compatibility with other Amstrad computers, set <i>c</i> to either 63 (#3F) or) (#00). 63 corresponds to bright; 0 to dark.
ESC d	Clears the viewport up to and including character at the cursor position. The cursor position is unaffected.
ESC e	Enables the cursor blob.
ESC f	Disables the cursor blob.
ESC j	Saves the cursor position.
ESC k	Restores the cursor position as saved by ESC j.
ESC l	Erases all the characters on the line. The cursor position is unaffected.
ESC o	Erases the line up to and including the character at the cursor position. The cursor position is unaffected.
ESC p	Enters reverse video mode. Printable characters are displayed with the foreground and background colours reversed.
ESC q	Leaves reverse video mode.
ESC r	Enters underline mode.
ESC u	Leaves underline mode.
ESC v	Selects wrapping at the end of the line.
ESC w	Cancel wrapping at the end of the line.
ESC x	Enters 24 x 80 mode.
ESC y	Leaves 24 x 80 mode.

Any other character after an ESC is displayed and the cursor advanced as above. Thus to display characters corresponding to control codes, send ESC followed by the control code. For example, ESC #0D will display .

Appendix IV

Error messages

IV.1 Disc handling errors

In all these cases, typing R causes the system to Retry; typing I causes the system to carry on to its next action; typing C causes the command to be abandoned.

As a general rule, Retry until you are convinced that there is a serious problem in reading from or writing to the disc. Then copy all the files you can onto another disc before reformatting the disc. As you will remember, reformatting a disc clears it of all the data stored on it.

drive not ready - Retry, Ignore or Cancel?

Usually means the drive you have just accessed has no disc in it. Put a disc in the drive and type R

write protected - Retry, Ignore or Cancel?

Means that you have tried to write to a write-protected disc. Write enable the disc and type R, or cancel the operation by typing C

track / seek fail - Retry, Ignore or Cancel?

May be caused by a drive fault, try 'Retrying' a few times.

track *t*, sector *s* data error - Retry, Ignore or Cancel?

Data is corrupted; may be caused by a damaged disc. Try 'Retrying' a few times.

track *t*, sector *s* no data - Retry, Ignore or Cancel?

May be caused by an unformatted disc. If this error persists, reformat the disc.

track *t*, sector *s* missing address mark - Retry Ignore or Cancel?

If this error persists, reformat the disc.

bad format - Retry, Ignore or Cancel?

Disc may be unformatted or of a totally alien format.

unknown error - Retry, Ignore or Cancel?

Try 'Retrying' a few times.

IV.2 Device errors

If you try to use a device (ie peripheral) that is either not attached or not working, the message *device not ready - Retry, Ignore or Cancel?*

will appear on the screen. *device* will be replaced by the name of the device: CEN for a Centronics printer; SIO for a serial port; LPT for a printer, etc.

The effect of typing R will be to try the operation again.

The effect of typing I will be to move on to the next part of the operation.

The effect of typing C will be both to cancel the present operation and to set up a 'Sink' so that all future output that is directed to that device will be thrown away.

IV.3 CP/M Plus error messages

Tabulated below are the error messages listed by Digital Research in its CP/M Plus User's Guide, together with an explanation of why the error occurred. The utility being used when the error occurred is given where appropriate.

In general, you should check that the command you gave was correct, check that the disc is properly inserted in the drive and try again.

The tables are reproduced by kind permission of Digital Research Inc.

<i>Message</i>	<i>Meaning</i>
Assign a password to this file.	SET. A password mode has been selected for this file but no password has been assigned.
Auxiliary device redirection not implemented.	GET and PUT, AUXIN and AUXOUT cannot be redirected to a file.
Bad character, re-enter	GENCPM. The character entered was not a number.

<i>Message</i>	<i>Meaning</i>
Bad close.	SAVE. An error occurred during the attempt to close the file, probably because the file is write-protected.
Bad Logical Device Assignment;	DEVICE. Only the following logical devices are valid: CONIN:, CONOUT:, AUXIN:, AUXOUT:, LST:.
BAD PARAMETER	PIP. You entered an illegal parameter in a PIP command. Retype the entry correctly.
Bad password.	RENAME. The password supplied by the user is incorrect.
Bank one not allowed.	GENCPM. Bank 1 cannot be defined as available during system generation.
Baud rate cannot be set for this device.	DEVICE. Only physical devices that have the SOFT-BAUD attribute can have their baud rates changed. To check the attributes of the physical device, type DEVICE physical-dev.

<i>Message</i>	<i>Meaning</i>
Cannot have both create and access time stamps.	SET. CP/M 3 supports either create or access time stamps, but not both.
Cannot label a drive with a file referenced.	SET. SET does not allow mixing of files and drives.
CANNOT OPEN SOURCE FILE	HEXCOM. The HEX file is not on the specified drive(s).
Cannot redirect from BIOS.	GET, PUT. This message is displayed as a warning only if the system has an invalid BIOS.
Cannot set both RO and RW.	SET. A file cannot be set to both Read-Only and Read-Write.
Cannot set both SYS and DIR.	SET. A file cannot be set to both SYS and DIR.
CAN'T DELETE TEMP FILE	PIP. A temporary \$\$\$ file already exists which is Read-Only. Use the SET command to change the attribute to Read-Write, then erase it.

<i>Message</i>	<i>Meaning</i>
Break "x" at c	<p>ED. "x" is one of the symbols described below and c is the command letter being executed when the error occurred.</p> <ul style="list-style-type: none"> # Search failure. ED cannot find the string specified in an F, N, or S command. ? Unrecognized command letter c. ED does not recognize the indicated command letter, or an E, H, O, or Q command is not alone on its command line. O The file specified in an R command cannot be found. > Buffer full. ED cannot put any more characters in the memory buffer, or the string specified in an F, N, or S command is too long. E Command aborted. A keystroke at the console aborted command execution. F Disk or directory full. This error is followed by either the disk or directory full message. Refer to the recovery procedures listed under these messages.
<p>CANNOT CLOSE: Cannot close file. CANNOT CLOSE FILE. CANNOT CLOSE DESTINATION FILE - filespec</p>	<p>GENCOM, HEXCOM, LIB-80™, LINK-80, MAC, PIP, RMAC, SUBMIT. An output file cannot be closed. This can occur if the disk is removed before the program terminates.</p>
<p>Cannot delete file.</p>	<p>GENCOM. CP/M cannot delete a file. Check to see if the COM file is Read-Only or password-protected.</p>

<i>Message</i>	<i>Meaning</i>
CHECKSUM ERROR. Checksum error	HEXCOM, PIP. A hex record checksum error was encountered. The hex record that produced the error must be corrected, probably by recreating the hex file.
Close error.	XREF. This message is preceded by the filename.XRF. The disk might have been removed before the program terminated.
Close operation failed.	COPYSYS. There was a problem in closing the file at the end of the file copy operation.
Closing file HELP.DAT Closing file HELP.HLP	HELP. HELP encountered error while processing the HELP.DAT or the HELP.HLP file.
COM file found and NULL option.	GENCOM. The NULL option implies that no COM file is to be loaded, just the RSXs.
.COM file required	DIR, ERASE, RENAME, TYPE. Options in the built-in command line require support from a transient COM file that CP/M 3 cannot find on disk.
COMMON ERROR:	LINK-80. An undefined common block has been selected.

<i>Message</i>	<i>Meaning</i>
CORRECT ERROR, TYPE RETURN OR CTRL-Z	PIP. A hex record checksum was encountered during the transfer of a hex file. The hex file with the checksum error should be corrected, probably by recreating the hex file.
CPMLDR error: failed to open CPM3.SYS	CPMLDR. The system file CPM3.SYS is missing.
CPMLDR error: failed to read CPM3.SYS	CPMLDR. An error occurred while reading CPM3.SYS.
CP/M Error on d: Disk I/O BDDS Function = xx File = filespec	CP/M displays the preceding message if the disk is defective or improperly formatted (wrong density).
CP/M Error on d: Invalid Drive BDDS Function = xx File = filespec	CP/M 3 displays the preceding message when there is no disk in the drive, the drive latch is open, or the power is off. It also displays the message when the specified drive is not in the system.
CP/M Error on d: Read/Only Disk BDDS Function = xx File = filespec	CP/M 3 does not allow you to erase, rename, update, or set attributes of a file residing in a Read-Only drive. Use the SET command to set the drive attribute to Read-Write.

<i>Message</i>	<i>Meaning</i>
CP/M Error on d: Read/Only File BDOS Function = xx File = filespec	CP/M 3 does not allow you to erase, rename, update, or set attributes of a file that is Read-Only. Use the SET command to set the file attribute to Read-Write.
Date and Time Stamping Inactive.	DIR. The DATE option was specified, but the disk directory has not been initialized with date/time stamping.
DESTINATION IS R/O, DELETE (Y/N)?	PIP. The destination file specified in a PIP command already exists and it is Read-Only. If you type Y, the destination file is deleted before the file copy is done. If you type N, PIP displays the message **NOT DELETED** and aborts the copy operation.
Device Reassignment Not Supported. Enter new assignment or hit RETURN.	DEVICE. A device assignment is invalid.
Directory already re-formatted.	INITDIR. The directory already has date/time stamping.

<i>Message</i>	<i>Meaning</i>
<p>Directory full DIRECTORY FULL</p>	<p>ED. There is not enough directory space for the file being written to the destination disk. You can use the OXfilespec command to erase any unnecessary files on the disk without leaving the editor.</p> <p>SUBMIT. There is not enough directory space on the temporary file drive to write the temporary file used for processing SUBMIT files. Use the SETDEF command to determine which drive is the temporary file drive. Use the ERASE command to erase unnecessary files or set the temporary file drive to a different drive and retry.</p> <p>LIB-80, LINK-80. There is no directory space for the output or intermediate files. Use the ERASE command to remove unnecessary files.</p> <p>GENCPM. There is no directory space for CPM3.SYS.</p> <p>HEXCOM. There is no directory space for the output COM file.</p>
<p>Directory needs to be reformatted for date/time stamps.</p>	<p>SET. A date/time option was specified, but the directory has not been initialized for date/time stamping. Use the INITDIR command to initialize the directory for date/time stamping.</p>
<p>DISK FULL</p>	<p>ED. There is not enough disk space for the output file. This error can occur on the E, H, W, or X commands. If it occurs with X command, you can repeat the command prefixing the filename with a different drive.</p>

Message	Meaning
DISK READ DISK READ ERROR: Disk read error: filespec DISK READ ERROR - filespec	GENCPM, HEXCOM, LIB-80, LINK-80, PIP. The disk file specified cannot be read.
DISK WRITE. Disk Write Error DISK WRITE ERROR: DISK WRITE ERROR - filespec	HEXCOM, LIB-80, LINK-80, PIP, SUBMIT. A disk write operation cannot be successfully performed probably because the disk is full. Use the ERASE command to remove unnecessary files.
Do you want another file? (Y/N)	PUT. Enter Y to redirect output to an additional file. Otherwise, enter N.
Drive defined twice in search path	SETDEF. A drive can be specified only once in the search path order.
Drive Read Only	ERASE, RENAME. The specified file is on a Read-Only drive and cannot be erased or renamed.
Drive specified has not been defined.	GENCPM. The drive specified has not been defined yet. Buffers have not been allocated for the drive.

<i>Message</i>	<i>Meaning</i>
Duplicate RSX in header. Replacing old by new. This file was not used.	GENCOM. The specified RSX is already attached to the COM file. The old one is discarded.
Duplicate input RSX.	GENCOM. Two or more RSXs of the same name are specified. GENCOM uses only one of the RSXs.
Equals (=) delimiter missing at line NN.	GENCPM. The equal sign is missing in the specified line.
END OF FILE, ^Z, ?	PIP encountered an unexpected end-of-file during a HEX file transfer.
End of line expected.	DEVICE, GET, PUT, SETDEF. The command typed does not have any further parameters. An end-of-line was expected. Any further characters on the line were ignored.
Error at end of line:	DEVICE, GET, PUT, SETDEF. The error detected occurred at the end of the input line.
Error on line nnnnn:	SUBMIT. The SUBMIT program displays its messages in the preceding format, where nnnnn represents the line number of the SUBMIT file. Refer to the message following the line number for explanation of the error.

<i>Message</i>	<i>Meaning</i>
FILE ERROR	ED. Disk or directory is full, and ED cannot write anything more on the disk. This is a fatal error, so make sure there is enough space on the disk to hold a second copy of the file before invoking ED.
File already exists; Delete it? (Y/N) file already exists, delete (Y/N)?	PUT. Enter Y to delete the file. Otherwise the program terminates. RENAME. The above message is preceded by filespec. You have asked CP/M 3 to create or rename a file using a file specification that is already assigned to another file. Either delete the existing file or use another file specification.
File cannot fit into GENCPM buffer: filename.SPR	GENCPM. There is not enough memory to generate a system.
File exists, erase it	ED. The destination filename already exists when you are placing the destination file on a different disk than the source. It should be erased or another disk selected to receive the output file.
FILE IS READ/ONLY File is Read Only	ED. The file specified in the command to invoke ED has the Read-Only attribute. ED can read the file so that you can examine it, but ED cannot change a Read-Only file. PUT. The file specified to receive the output is a Read-Only file.

<i>Message</i>	<i>Meaning</i>
FILE NAME ERROR:	LIB-80. The form of a source filename is invalid.
File not found. FILE NOT FOUND - filespec	DUMP, ED, GENCOM, GET, PIP, SET. An input file that you have specified does not exist. Check that you have entered the correct drive specification or that you have the correct disk in the drive.
First submitted file must be a COM file.	GENCOM. A COM file is expected as the first file in the command tail. The only time GENCOM does not expect to see a COM file in the first position of the command tail is when the NULL option is specified.
FIRST COMMON NOT LARGEST:	LINK-80. A subsequent COMMON declaration is larger than the first COMMON declaration for the indicated block. Check that the files being linked are in the proper order, or that the modules in a library are in the proper order.
HELP.DAT not on current drive.	HELP. HELP cannot find HELP.DAT file to process.
Illegal command tail.	DIR. The command line has an invalid format or option.

<i>Message</i>	<i>Meaning</i>
Illegal Format Value.	DIR. Only SIZE and FULL options can be used for display formats.
Illegal Global/Local Drive Spec Mixing.	DIR. Both a filespec with a drive specifier and the DRIVE option appears in the command.
Illegal filename.	SAVE. There is an error in the filespec on the command line.
Illegal Option or Modifier.	DIR. An invalid option or abbreviation was used.
Illegal date/time specification.	DATE. Date/time format is invalid.
Incorrect file specification.	RENAME. The format of the filespec is invalid.
INDEX ERROR:	LINK-80. The index of an IRL contains invalid information.
Insufficient Memory INSUFFICIENT MEMORY:	GET, LINK-80, PUT, SUBMIT. There is not enough memory to allocate buffers, or there are too many levels of SUBMIT nesting.

<i>Message</i>	<i>Meaning</i>
Invalid ASCII character	SUBMIT. The SUBMIT file contains an invalid character (OFFH).
Invalid character at line NN.	GENCPM. The character must be a number.
Invalid command.	GET and PUT. The string or substring typed in the command line was not recognized as a valid command in the context used.
Invalid delimiter.	DEVICE, GET, PUT, SETDEF. The delimiter, [] , = or space, — was not valid at the location used. For example, a [was used where an = should have been used.
INVALID DESTINATION:	PIP. An invalid drive or device was specified.
INVALID DIGIT - filespec	PIP. An invalid hex digit has been encountered while reading a hex file. The hex file with the invalid hex digit should be corrected, probably by recreating the hex file.
Invalid drive.	SETDEF. The specified drive was not a valid drive. Drives recognized by SETDEF are * (default drive) and A to P. GENCPM, TYPE. Valid drives are A to P.

<i>Message</i>	<i>Meaning</i>
Invalid drive ignored at line NN.	GENCPM. Valid drives are A to P.
Invalid drive name (Use A, B, C, or D)	COPYSYS, GENCPM. Only drives A, B, C and D are valid destination drives for system generation.
Invalid File. INVALID FILENAME Invalid file name. Invalid Filename. Invalid file specification.	ED, ERASE, GENCOM, GET, PIP, PUT, SET, SUBMIT, TYPE. The filename typed does not conform to the normal CP/M 3 file naming conventions.
INVALID FORMAT	PIP. The format of your PIP command is illegal. See the description of the PIP command.
INVALID HEX DIGIT,	HEXCOM. An invalid hex digit has been encountered while reading a hex file. The hex file with the invalid hex digit should be corrected by recreating the hex file.
Invalid number.	DEVICE. A number was expected but not found, or the number was out of range; numbers must be from 0 to 255.

<i>Message</i>	<i>Meaning</i>
Invalid option.	<p>DEVICE and GET. An option was expected and the string found was not a device option or was not valid in the context used.</p> <p>SETDEF. The option typed in the command line is not a valid option. Valid options are DISPLAY, NO DISPLAY, NO PAGE, ORDER, PAGE, TEMPORARY.</p>
Invalid option or modifier.	<p>DIR, GET, PUT. The option typed is not a valid option.</p>
INVALID PARAMETER:	<p>MAC, RMAC. An invalid assembly parameter was found in the input line. The assembly parameters are printed at the console up to the point of the error.</p>
Invalid parameter variable at line NN.	<p>GENCPM. The parameter variable does not exist. Check spelling.</p>
INVALID PASSWORD Invalid password or passwords not allowed.	<p>ED, PIP. The specified password is incorrect, or a password was specified, but the file is not password-protected.</p>
Invalid physical device.	<p>DEVICE. A physical device name was expected. The name found in the command string does not correspond to any physical device name in the system.</p>

<i>Message</i>	<i>Meaning</i>
INVALID REL FILE:	LINK-80. The file indicated contains an invalid bit pattern. Make sure that a REL or IRL file has been specified.
Invalid RSX type.	GENCOM. Filetype must be RSX.
Invalid SCB offset.	GENCOM. The specified SCB is out of range. The SCB offset range is 00H-64H.
INVALID SEPARATOR	PIP. You have placed an invalid character for a separator between two input filenames.
INVALID SOURCE	PIP. An invalid drive or device was specified. AUX and CON are the only valid devices.
Invalid type for ORDER option.	SETDEF. The type specified in the command line was not COM or SUB.
Invalid SYM file format	XREF. The filename.SYM file input to XREF is invalid.
INVALID USER NUMBER	PIP. You have specified a user number greater than 15. User numbers are in the range 0 to 15.

<i>Message</i>	<i>Meaning</i>
Invalid wildcard,	RENAME. The filespec contained an invalid wildcard specification.
Invalid wildcard in the FCB name or type field,	GENCOM. GENCOM does not allow wildcards in filespecs.
LOAD ADDRESS LESS THAN 100,	HEXCOM. The program origin is less than 100H.
MAIN MODULE ERROR:	LINK-80. A second main module was encountered.
Make error	XREF. There is not more directory space on the specified drive.
Memory conflict - cannot trim segment,	GENCPM. The defined memory segment overlaps another segment.
Memory conflict - segment trimmed,	GENCPM. The defined memory segment overlaps with other segments.
MEMORY OVERFLOW:	LINK-80. There is not enough memory to complete the link operation.

<i>Message</i>	<i>Meaning</i>
Minimum number of buffers is 1.	GENCPM. The first drive must have at least one buffer defined.
Missing Delimiter or Unrecognized Option.	ERASE. The ERASE command line format is invalid.
Missing parameter variable at line NN.	GENCPM. The line is missing a variable name.
Missing left parenthesis.	GENCOM. The SCB option must be enclosed by a left parenthesis.
Missing right parenthesis.	GENCOM. The SCB option is not enclosed with a right parenthesis.
Missing SCB value.	GENCOM. The SCB option requires a value.
More than four drives specified.	SETDEF. More than four drives were specified for the drive search chain.
MULTIPLE DEFINITION:	LINK-80. The specified symbol is defined in more than one of the modules being linked.

<i>Message</i>	<i>Meaning</i>
n?	USER. You specified a number greater than fifteen for a user area number. For example, if you type USER 18, the screen displays 18?
No directory label exists.	SHOW. The LABEL option was requested but the disk has no label.
No directory space NO DIRECTORY SPACE - filespec	COPYSYS, GENCOM, MAC, PIP, RMAC, AND SAVE. There is not enough directory space for the output file. Use the ERASE command to remove unnecessary files on the disk and try again.
No disk space.	SAVE. There is not enough space on the disk for the output file. Use the SHOW command to display the amount of disk space left and use the ERASE command to remove unnecessary files from the disk, or use another disk with more file space.
No file NO FILE: NO FILE - filespec	DIR, ERASE, LIB-80, LINK-80, PATCH, PIP, RENAME, TYPE. The specified file cannot be found in the specified drive(s).
No HELP.HLP file on the default drive.	HELP. The file HELP.HLP must be on the default drive.

<i>Message</i>	<i>Meaning</i>
Not enough available memory. Not Enough Memory Not Enough Memory for Sort.	DIR, INITDIR. There is not enough memory for data or sort buffers.
Not enough room in directory.	INITDIR. There is not enough remaining directory space to allow for the date and time extension.
NOT FOUND	PIP. PIP cannot find the specified file.
Not renamed, filespec read only.	RENAME. The specified file cannot be renamed because it is Read-Only.
OPEN FILE NONRECOVERABLE	PIP. A disk has the wrong format or a bad sector.
Option only for drives.	SET. The specified option is not valid for files.
Option requires a file reference.	SET. The specified option requires a filespec.
Out of data space.	COPYSYS. The destination drive ran out of space during the transfer of the CPM3.SYS file.

<i>Message</i>	<i>Meaning</i>
Options not grouped together.	DIR. Options can only be specified within one set of brackets.
Output File Exists, Erase it.	The output file specified must not already exist.
OUTPUT FILE READ ERROR:	MAC, RMAC. An output file cannot be written properly, probably because the disk is full. Use the ERASE command to delete unnecessary files from the disk.
OVERLAPPING SEGMENTS:	LINK-80. LINK-80 attempted to write a segment into memory already used by another segment.
Page and nopage option selected. No page in effect.	SET. The preceding options are mutually exclusive.
Parameter Error	SUBMIT. Within the SUBMIT file of type SUB, valid parameters are \$0 through \$9.
Password Error.	DUMP, ERASE, GENCOM, TYPE. The password is incorrect.
Physical Device Does Not Exist.	DEVICE. The specified physical device is not defined in the system.

<i>Message</i>	<i>Meaning</i>
Possible incompatible disk format.	COPYSYS. The system disk and the output disk have different formats.
PROGRAM INPUT IGNORED.	SUBMIT. This message is preceded by "WARNING". The SUBMIT file contains a line with <, and the program does not require additional input.
PUT >	PUT. This prompt occurs when a program requests input while running a PUT FILE [NO ECHO] command.
PUT ERROR: FILE ERASED.	PUT. The PUT output file was erased and could not be closed.
QUIT NOT FOUND	PIP. The string argument to a Q parameter was not found in your input file.
Random Read	SUBMIT. An error occurred when reading the temporary file used by the SUBMIT command.
Read only.	GENCOM, SET. The drive or file specified is write-protected.
Read error	TYPE. An error occurred when reading the file specified in the TYPE command. Check the disk and try again.

<i>Message</i>	<i>Meaning</i>
Reading file: filespec	GENCPM. An error occurred while attempting to read the file specified by filespec.
Reading file HELP.HLP Reading HELP.HLP index	HELP. An error occurred while reading HELP.HLP. Copy the HELP.HLP file from the system disk.
RECORD TOO LONG	PIP. A HEX record exceeds 80 characters in a file being copied with the [H] option.
Requires CP/M 3.0 or higher.	DATE, DEVICE, DIR, ERASE, GENCOM, HELP, INITDIR, PIP, SET, SETDEF, SHOW, RENAME, TYPE. This version of the utility must only be run under CP/M 3.0 or higher.
R/O DISK	PIP. The destination drive is set to Read-Only and PIP cannot write to it.
R/O FILE	PIP. The destination file is set to Read-Only and PIP cannot write to it.
Sort Stack Overflow	DIR. There is not enough memory available for the sort stack.

<i>Message</i>	<i>Meaning</i>
Source file is incomplete.	GENCPM. GENCPM cannot use your CP/M 3 system source file.
SOURCE FILE READ ERROR:	MAC, RMAC. The source file cannot be read properly by MAC.
SOURCE FILENAME ERROR:	MAC, RMAC. The form of the source filename is invalid.
START NOT FOUND	PIP. The string argument to an S parameter cannot be found in the source file.
Symbol Table overflow	XREF. No space is available for an attempted symbol allocation.
Symbol Table reference overflow	XREF. No space is available for an attempted symbol reference allocation.
SYNTAX ERROR:	LIB. The LIB-80 command is not properly formed.
Too many entries in Index Table. Not enough memory	HELP. There is not enough memory available to hold the topic table while creating HELP.HLP.

<i>Message</i>	<i>Meaning</i>
<p>Topic: xxxxxxx Not found.</p>	<p>HELP. The topic requested does not exist in the HELP.HLP file. HELP displays the topics available.</p>
<p>Total file size exceeds 64K.</p>	<p>GENCOM. The output file exceeds the maximum allowed.</p>
<p>Try 'PAGE' or 'NO PAGE'</p>	<p>TYPE. The only valid option is PAGE or NO PAGE.</p>
<p>Unable to allocate Data deblocking buffer space.</p>	<p>GENCPM. There is not enough space left in generated system to allocate a data deblocking buffer.</p>
<p>Unable to allocate Dir deblocking buffer space.</p>	<p>GENCPM. There is not enough space left in generated system to allocate a directory deblocking buffer.</p>
<p>Unable to allocate space for hash table.</p>	<p>GENCPM. There is not enough contiguous memory to allocate space for the hash table in the generated system.</p>
<p>Unable to close HELP.DAT. Unable to close HELP.HLP.</p>	<p>HELP. An error occurred while closing file HELP.HLP or HELP.DAT. There might not be enough disk or directory space on the drive.</p>

<i>Message</i>	<i>Meaning</i>
Unable to find file HELP.HLP.	HELP. HELP requires HELP.HLP file to operate. Copy it to your default drive from your CP/M 3 system disk.
Unable to Make HELP.DAT. Unable to Make HELP.HLP.	HELP. There is not enough space on the disk for HELP.HLP or HELP.DAT, or the files are Read-Only.
Unable to open: filename.SPR	GENCPM. The file specified cannot be found on the default drive.
UNBALANCED MACRO LIBRARY.	MAC, RMAC. A MACRO definition was started within a macro library, but the end of the file was found in the library before the balancing ENDM was encountered.
UNDEFINED START SYMBOL:	LINK-80. The symbol specified with the G switch is not defined in any of the modules being linked.
UNDEFINED SYMBOLS:	LINK-80. The symbols following this message are referenced but not defined in any of the modules being linked.
UNEXPECTED END OF HEX FILE - filespec	PIP. An end-of-file was encountered before a termination hex record. The hex file without a termination record should be corrected, probably by recreating the hex file.

<i>Message</i>	<i>Meaning</i>
Unrecognized drive.	SHOW. The specified drive is not valid. Valid drives are A to P.
UNRECOGNIZED ITEM:	LINK-80. An unfamiliar bit pattern has been scanned and ignored by LINK-80.
Unrecognized input.	SHOW. The SHOW command line has an invalid format.
Unrecognized option.	GENCOM and SHOW. An option typed in the command line is not valid for the command.
USER ABORTED	PIP. You stopped a PIP operation by pressing CTRL-C.
VERIFY ERROR: - filespec	PIP. When copying with the V option, PIP found a difference when rereading the data just written and comparing it to the data in its memory buffer.

<i>Message</i>	<i>Meaning</i>
Write error	XREF. This message is preceded by filename.XRF and indicates that no disk space is available, or no directory space exists on the specified drive.
Write protected?	COPYSYS. The drive or disk to which the system is to be written is Read-Only.
Writing file: filespec	GENCPM, HELP. An error occurred while attempting to write the file specified by filespec.
Wrong Password.	SET. The specified password is incorrect or invalid.
Zero length segment not allowed.	GENCPM. A memory segment cannot have zero length.
OFFFHH is an invalid value in the DPH directory BCB address field.	GENCPM. This value is allowed only in the DTABCB field.
?	SID. SID has encountered an error.

MAC/RMAC error messages

<i>Flag</i>	<i>Meaning</i>
B	Balance error: macro does not terminate properly, or conditional assembly operation is ill formed.
C	Comma error: expression was encountered but not delimited properly from the next item by a comma.
D	Data error: element in a data statement (DB or DW) cannot be placed in the specified data area.
E	Expression error: expression is ill formed and cannot be computed at assembly time.
I	Invalid character error: a nongraphic character has been found in the line other than a carriage return, line-feed, tab, or end-of-file; edit the file, delete the line with the I error, and retype the line.
L	Label error: label cannot appear in this context; it might be a duplicate label.
M	Macro overflow error: internal macro expansion table overflow; might be due to too many nested invocations or infinite recursion.
N	Not implemented error: features that appear in RMAC, such as relocation, are recognized, but flagged in MAC.

<i>Message</i>	<i>Meaning</i>
O	Overflow error: expression is too complicated (i.e., has too many pending operators), string is too long, or too many successive substitutions of a formal parameter by its actual value in a macro expansion. This error also occurs if the number of LOCAL labels exceeds 9999.
P	Phase error: label does not have the same value on the two passes through the program, or the order of macro definition differs between the two successive passes; might be due to MACLIB that follows a mainline macro; if so, move the MACLIB to the top of the program.
R	Register error: the value specified as a register is not compatible with the operation code.
S	Syntax error: the fields of this statement are ill formed and cannot be processed properly; might be due to invalid characters or delimiters that are out of place.
U	Undefined symbol: a label operand in this statement has not been defined elsewhere in the program.
V	Value error: operand encountered in an expression is improperly formed; might be due to delimiter out of place or nonnumeric operand.

LIB-80 error messages

<i>Error</i>	<i>Cause</i>
CANNOT CLOSE :	LIB-80 cannot close the output file. The disk might be write-protected.
DIRECTORY FULL :	There is no directory space for the output file.
DISK READ ERROR :	LIB-80 cannot read the file properly.
DISK WRITE ERROR :	LIB-80 cannot write to the file properly, probably due to a full disk.
FILE NAME ERROR :	The form of a source filename is invalid.
NO FILE :	LIB-80 cannot find the indicated file.
NO MODULE :	LIB-80 cannot find the indicated module.
SYNTAX ERROR :	The LIB-80 command line is not properly formed.

Overlay Manager run-time error messages

<i>Error</i>	<i>Cause</i>
ERROR (8) OVERLAY, NO FILE d:filename.OVL	The Overlay Manager cannot find the indicated file.
ERROR (9) OVERLAY, DRIVE d:filename.OVL	An invalid drive code was passed as a parameter to ?ovlay.
ERROR (10) OVERLAY, SIZE d:filename.OVL	The indicated overlay would overwrite the P/I stack and/or free space if it were loaded.
ERROR (11) OVERLAY, NESTING d:filename.OVL	Loading the indicated overlay would exceed the maximum nesting depth.
ERROR (12) OVERLAY, READ d:filename.OVL	Disk read error during overlay load, probably caused by premature EOF.

Index

- A4 paper, 4, 44, 91
 - A5 paper, 44, 91
 - A: drive, 2, ptIII
 - A > prompt, 3
 - Active (printer), 120
 - ALT key, 20, 92, 108
 - American character set, 89, 104, 134
 - ASCII, 86, 103
 - ASM file, 100
 - Assembler, 100
 - cross reference, 101
 - ASSIGN.SYS, 60, 63
 - Attributes
 - file and drive, 83
 - AUX., 78
 - Auxilliary I/O, 78
 - AUXIN., 87
 - AUXOUT., 87

 - B: drive, 2, ptIII
 - Backspace code, 128
 - Bail bar, 41
 - Bail bar out, 45
 - BAS, 2
 - BASIC, 1
 - Batch of commands, 85
 - Baud rate, 88, 94
 - Bit image, 125, 136
 - BITS, 94
 - Bold print, 132
 - Booting CP/M
 - see Loading CP/M, 3

 - Carriage return code, 128
 - Case
 - upper and lower, 7, 79
 - Centronics interface, 88, 94
 - CHAR key, 28
 - Characters
 - changing the keyboard, 92
 - Character sets, 103
 - CP/M default (US), 113
 - list of, 105

 - Characteristics of drive, 84
 - Clock, 87
 - Codes
 - control, 20, 68
 - internal, 20
 - Column number, 139
 - COM, 2, 99
 - COM file, 100
 - Command file, 99
 - Command lines, 2, 6
 - changing, 16, 28
 - editing, 28
 - in .SUB files, 50
 - sequences of, 15, 46, 85
 - shortening, 50
 - Commands, 6, 19
 - built-in, 2
 - transient utilities, 2
 - Comment, 92
 - Commercial software, 53
 - graphics software, 60
 - Communications interface, 88
 - CON., 40, 78
 - Condensed print, 123, 131
 - Confirm files to copy, 79
 - CONIN., 87
 - CONOUT., 87, 139
 - Console
 - see Screen and Keyboard, 56
 - Continuous stationery, 44, 90
 - Control characters
 - see control codes
 - Control codes, 20, 68, 92, 110
 - list of, 113
 - printer, 122
 - screen, 139
 - Control-C, 52
 - Control-P, 40
 - Conventions, 20, 68
 - COPY key, 16, 28
 - Copying
 - discs, 4, 22, 73, ptIII
 - files, 10, 11, 24, ptIII
-

old command line, 28
single disc drive, 16
system files, 79

CP/M, 6
 commands, 6, 19
 commercial software, 53
 graphics extension, 59
 initial command sequence, 15
 loading, 27
 restarting, 49
 running programs, 6
 starting, 3
 utilities, 6, 67

CP/M 2.2, 53

CP/M Plus, 1

Creating files, 26

Cross reference assembler, 101

Cursor, 3

Cursor movement keys, 28

Cursor position, 140

Danish character set, 89, 104, 134

Data
 bits, 94
 where to store, 54

Data only discs, 37

DATE, 87

Date stamping, 77, 83

DDFXHR8.PRL, 60

DDFXLR8.PRL, 60

DDHP7470.PRL, 60

DDSCREEN.PRL, 60

Debugger, 101

Default drive, 2, 19, 50
 changing, 9, 52

DEL keys, 6, 16, 28

Deleting files, 12, 34

DEVICE, 87
 graphics, 59
 I/O, 78
 number, 63

Device driver, 60
 technical information, 65

DIR, 6, 36, 38, 70, ptIII

DIR option, 21

Directories, 6, 13, 70, ptIII
 attributes, 83, ptIII
 number of files, 14, ptIII
 number of free entries, 21, 84, ptIII
 system files, 71

DIRSYS, 38

Disc drive, 2

DISCKIT, 22, 37, 73, ptIII

Discs
 care of, 3
 changing, 52
 changing default, 9
 copying, 4, 22, 73, ptIII
 data only, 37
 default, 2, 19
 directory of, 6, ptIII
 for commercial software, 54
 formatting, 37, 73, ptIII
 free directory entries, 21, 84, ptIII
 free space, 14, 21, 84, ptIII
 housekeeping, 11
 information about, 84
 labelling, 83
 listing files on, 6, 38
 master, 4
 memory, 9
 other than default, 9
 search order, 50, 84
 start of day, 27, 54
 switching between, 52
 system, 1, 4
 verifying, 73, ptIII
 write protection, 22

Double strike print, 132

Dr. Logo, 1

Draft quality printing, 42, 43, 120, 124, 132

Drives
 attributes, 83, ptIII
 number of, 16, ptIII

DUMP, 96

ED, 26, 29, 96
 commands, 31, 97

Editing
 command line, 28
 large text files, 30

machine code files, 100
text, 29

Editor
line based, 26, 29
screen based, 26, 29

Elite printing, 123, 131

Emphasised print, 132

EMS, 2

End of file
marker in file, 79

English character sets, 89, 104, 134

Enlarged printing, 123, 131

EOF, 78

EOL key, 28

Epson FX-80, 56

ERASE (ERA), 12, 34, 75

Erasing files, 12, 34
confirm option, 12

Errors
CP/M Plus, 144
disc handling, 143
ED, 32, 98
GSX, 64
printer, 44

Escape codes, 122

Expansion string, 92, 108, 110
initial values, 112

Expansion token, 92

EXTRA key, 92, 108

FD-2 drive, ptIII

FF, 43, 120

Filenames, 2, 7, 70
matching, 8
template, 8
wildcards, 8

Files, 2
attribute, 83
changing contents of, 100
combining, 78
command, 8
copying, 10, 24, 78, 79
copying system, 79
directories of, 13, 70
displaying contents, 14, 40, 86
displaying hex contents, 96
displaying names, 70
editing, 29
erasing, 12, 35, 75
for use with GSX, 60
Hex format, 99
information on, 38
maximum number, 14
names, 2, 7
object, 99
on disc, 6, 38, ptIII
patch, 100
printing contents, 40
read only, 70
REL format, 99
renaming, 11, 48, 82
replace text, 32
room for, 14, 21
saved from memory, 101
search for text, 32
sequence of commands, 15
size of, 13, 36, 39, 70, ptIII
specification of, 10
system, 38, 70, 71
typing, 14, 40

Filetypes, 2, 7

Finish using CP/M, 49

Form feed, 43, 120, 128

Form length, 90

Formatting discs, 37, 73, 74, ptIII

Free directory entries, 14, 21, ptIII

Free disc space, 14, 21, ptIII

French character set, 89, 104, 134

Function keys, 110
defining, 92

Gap length, 90, 129

GENCOM, 99

GENGRAF, 60, 62

German character set, 89, 104, 134

GET, 76

Graphics, 59
commercial software, 61
dual density, 125, 136
normal density, 125, 136
printing, 124

GSX, 59, 60
 combining with a program, 62
 installing, 61
 logical device number, 63
 technical information, 65

HANDSHAKE, 94

HELP, 102

HEX format file, 99, 100

Hexadecimal
 #, 20
 notation, 20

HEXCOM, 99

High quality printing, 42, 43, 120, 124, 132

Housekeeping, 11

INITDIR, 77

Insert mode, 26

Installing commercial software, 53, 55, 121

Installing GSX, 61

Interface
 RS232C/Centronics, 94

Internal codes, 20

Inverse video, 90

Italian character set, 89, 104, 134

Italic characters, 124, 132

Japanese character set, 134

k, 14

Key
 number, 108
 shift state, 108

Key definition file, 108

Keyboard, 78, 87, 89
 common codes, 57
 get input from file, 76
 national variations, 104
 redefining, 92, 108
 redefining function keys, 47
 use by commercial software, 56

Kill files, 34

Kilobyte, 14

LANGUAGE, 89
 of printer, 134
 variations, 104

LF, 43, 120

LIB, 99

Library, 99

Line editor, 26, 29

Line feed, 43, 120, 128

LINE key, 28

Line numbers, 79

Line pitch, 90

Line spacing codes, 126

Lines
 horizontal on screen, 3
 on paper, 43
 per inch, 90

LINK, 100

Loading CP/M, 3, 27, 49
 initial command sequence, 15, 46

Loading paper, 41

Logical devices, 87
 numbers, 63

LOGO, 1

Lower case, 7, 79

LST:, 40, 78, 87

M: drive,
 see Memory disc

MAC, 100

Macros, 100
 see SUBMIT, 15

Mallard BASIC, 1

Margin codes, 126

Matching filenames, 8

Memory disc, 9

Metalanguage, 20, 68

Microcomputer, 1

Modem, 88

Monitor, 87

No printer, 45, 120

NOXON, 88

NUL:, 78

Object modules, 99

Off-line, 42, 43, 120

On-line, 42, 43, 120
Options to commands, 12
ORDER, 50
Out of paper, 45, 120
Output device, 59

Page layout codes, 126
Page length, 129
Pages, 90
PALETTE, 90
PAPER, 44, 90
 A4, 91
 A5, 91
 adjusting in printer, 42
 end detection, 91, 128
 loading into printer, 41
 out of, 45, 120
 types of, 44
 waiting for, 45, 120
Paper end detection, 121
Paper Out Defeat, 91, 121
Parameters to SUBMIT, 85
PARITY, 94
Parity bit, 79
Passwords, 83
PASTE key, 28
PATCH, 100
Peripherals, 78, 87
Physical devices, 87
Pica, 123, 131
PIP, 10, 24, 78, ptIII
 options, 79
Pitch, 90
Pixel, 124
Plotter
 GSX, 60, 62
Pointer, 31
Post-mortem dump, 101
Print files, 86
Printer, 41, 78
 A4 paper, 44
 A5 paper, 44
 active, 120
 adjusting paper, 42
 advanced use, 119
 alternative under GSX, 62
 backspace, 128
 bail bar out, 45
 bit image, 125
 buttons, 43, 119
 carriage return, 128
 clear, 130
 common codes, 57
 continuous stationery, 44
 control codes, 122, 126
 control state, 43, 119
 controlling from BASIC, 123
 default, 91
 device, 87
 draft quality printing, 42, 43, 121
 dual density, 125, 136
 FF, 43, 121
 form feed, 43, 121, 128
 graphics, 124, 125, 136
 GSX, 60
 high quality printing, 42, 43, 121
 initialisation, 93
 LF, 43, 121
 limitations, 124
 line feed, 43, 121, 128
 line pitch, 123
 lines per inch, 123
 loading paper, 41
 national variations, 134
 no printer, 120
 normal density, 125, 136
 off-line, 42, 120
 on-line, 42, 120
 out of paper, 45, 120
 page length, 129
 paper end detection, 121
 Paper Out Defeat, 121
 pitch, 123
 pixels, 124
 redirect data to file, 80
 reset, 130
 setting options, 121
 single sheet stationery, 44, 129
 skip gap, 129
 tabs, 127
 top of form, 43
 troubleshooting, 44

types of paper, 44
typstyles, 123
use by commercial software, 56
waiting for paper, 45, 120
when CP/M starts, 4
zero with slash, 135

Printing
 mixed mode, 133

PRN file, 100

PRN., 78

Procedures
 see SUBMIT, 15

PROFILE.SUB, 15, 27, 46, 55, 111

Programs
 commercial, 53
 graphics, 59
 Hex format, 99
 installing, 53, 55
 listing names of, 8
 object, 99
 redirecting input, 76
 REL format, 99
 running, 6
 stored, 2
 turnkey operation, 55

Proportional spacing, 123, 131

PTR key, 43

PUT, 80

Read only files, 70

REL format file, 99, 100

RELAY key, 28

RENAME(REN), 11, 82

Renaming files, 11, 48

Replace text in files, 32

Reset, 49

Resident system extension, 99

RETURN key, 6

RMAC, 100

Row number, 139

RPED, 26, 29

RS232C, 88, 94

RSX, 99

Running programs, 6

RX, 94

SAVE, 101

Screen, 78, 87, 90
 changing size, 95
 common codes, 58
 cursor position, 140
 redirect data to file, 80
 status line, 140
 use by commercial software, 56

Screen control, 139

Screen editor, 26, 29

Search text files, 32

Seikosha SP-800, 56

Sequence of commands, 15

Serial interface, 88, 94

SET, 83

SET24X80, 95

SETDEF, 15, 50, 84

SETKEYS, 47, 56, 92, 108

SETLST, 93

SETSIO, 94

SHIFT key, 92, 108

Shift states, 92, 108

SHOW, 14, 21, 84, ptIII

SID, 101

Single sheet stationery, 44, 90, 129

SIO, 87

Sizes of files, 13, 36, 70, ptIII

Software
 see Programs, 6

Space free on a disc, 84

Spanish character set, 89, 104, 134

Special characters
 * ?, 8

Square brackets, 13

Start of day disc, 27, 54

Starting
 CP/M, 3, 15, 27
 the printer, 4

Stationery, 90

Status line, 140

STOP, 94

Stop bits, 94

STOP key, 52

SUBMIT, 15, 46, 50, 85

Subscript printing, 133

Superscript printing, 133

Swedish character set, 104, 134
SYM file, 100
Symbolic debugger, 101
System discs. 1, 4
System files, 38, 70, 71
 copying, 79
System prompt, 3

Tab codes, 127
Technical information
 character sets, 103
 GSX, 65
 keyboard, 109
 printer, 119
 printer control codes, 126
 screen, 139
Template for filenames, 8
Terminal, 139
 see Screen and Keyboard, 56
Text editor, 26, 29
Time of day, 87
Time stamping, 77, 83
Top of form, 42, 43
TPA, 1
Trace back, 101
Transient utilities, 1
Turnkey operation, 55
TX, 94
TYPE, 14, 40, 86
Typestyles, 123

UK character set, 89, 104, 134
Underlined printing, 133
Update text file, 29
Upper case, 7, 79
US character set, 89, 104, 134
USER, 86
User number, 79
Users, 70, 84
Utilities, 1, 6
 accessible disc, 10
 memory disc, 10
 on many drives, 15
 search drives, 50, 84
 transfer to memory disc, 15
 transient, 1

Variables in .SUB files, 85
Verifying file copy, 74, 79
Verifying discs, 73
Viewport, 139
VT52, 139

Waiting for paper, 45, 120
Wildcards, 8, 11, 12, 38
Window, 139

XOFF, 88
XON, 88, 94
XREF, 101

Zenith Z19/Z29, 56, 139

Dr. Logo

CONTENTS

An introduction to LOGO **1**

Starting to use Dr. Logo **3**

- 2.1 Directing the turtle 3
 - 2.1.1 Multiple instructions 4
- 2.2 Procedures 5
 - 2.2.1 Procedures with inputs 5
- 2.3 Variables in LOGO 7
 - 2.3.1 Local and Global Variables 7
- 2.4 Editing 8
- 2.5 Saving procedures 9

A summary of Dr. Logo primitives **11**

- 3.1 Turtle graphics 11
- 3.2 Graphics screen 12
- 3.3 Text screen 12
- 3.4 Variables 13
- 3.5 Arithmetic operations 14
- 3.6 Logical operations 14
- 3.7 Procedures 15
- 3.8 Flow of control 15
- 3.9 Word and list processing 16
- 3.10 Disc handling 17
- 3.11 Taking data from the keyboard 17
- 3.12 Controlling the printer 17
- 3.13 Handling picture files 18

Appendix I: Primitives supported on the PCW8256 **19**

Appendix II: Dr. Logo error messages **21**

The PCW8256 keyboard for Dr. Logo

The main keyboard

The lower character on any key and lower case letters are produced by single keystrokes. The upper character and upper case letters are produced by pressing the **[SHIFT]** key simultaneously.

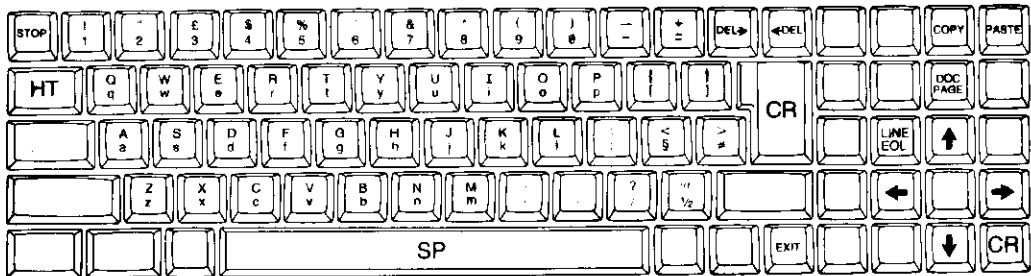

The keyboard with ALT

The lower character on any key is produced by pressing it and the **[ALT]** key simultaneously. The upper characters are produced by pressing the **[SHIFT]** key as well. The extra **[SHIFT]** is optional in producing the CP/M control codes (*^* character).



The keyboard with EXTRA

The character shown on any key is produced by pressing it and the **[EXTRA]** key simultaneously.

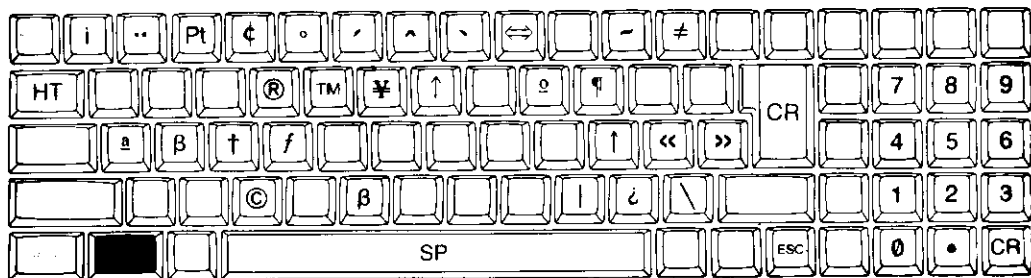

Special key combinations

[ALT] + **[ENTER]** acts as a Caps Lock key, setting/clearing the conversion of all lower case characters except Greek characters to their upper case counterpart.

[ALT] + **[RELAY]** acts as a Num Lock key, setting/clearing the use of a group of special keys as a numeric keypad.

[SHIFT] + **[EXTRA]** + **[EXIT]** resets the computer.

An introduction to LOGO

LOGO is a powerful programming language but it is particularly easy to learn.

It was developed in the 1970s by a team of computer scientists and educators, led by Seymour Papert of the Massachusetts Institute of Technology (MIT). Their idea was to produce a language that would be easy to experiment with and so make it easy to pick up the concepts of both mathematics and computer programming.

A key feature of LOGO is the Turtle which obeys simple instructions. This is usually a character on a computer screen. Papert and his team called it a Turtle to help children using LOGO to visualise what they were giving instructions to.

On the PCW8256, LOGO is a specially customised version of Digital Research's Dr. Logo. The turtle is shown on the screen as an arrowhead.

In addition, the actions of some of the keys are set up to assist you in using Dr. Logo. This means that some keys don't have the same effect as they did while you were using LocoScript, Mallard BASIC or other CP/M software. So always refer to the keyboard layout opposite when running CP/M.

The basic instructions Dr. Logo understands are called Primitives. These have predefined effects. For example, `fd` instructs the turtle to move forwards, `bk` instructs it to move backwards, `rt` instructs it to turn to the right and `lt` instructs it to turn to the left.

In all, there are some two hundred primitives, not just handling movements on the screen but arithmetic and information processing as well. Their names make up Dr. Logo's basic vocabulary.

The best way to learn what sort of things you can do with the Dr. Logo primitives is to experiment with them. The next chapter encourages you to do just that.

Starting to use Dr. Logo

Dr. Logo can be run only after starting up CP/M from your working system disc (Side 2). It is important that your working system disc has had its PROFILE.ENG file renamed to PROFILE.SUB as described on page 15 of the CP/M section of this manual. If you have not yet carried out this procedure, do so as follows:

First of all, insert your working CP/M system disc (NOT the master system disc provided) and start up CP/M by holding down **[SHIFT]** , **[EXTRA]** and **[EXIT]** .

Now type:

```
REN PROFILE.SUB=PROFILE.ENG [RETURN]
```

(If you now start up CP/M again by holding down **[SHIFT]** , **[EXTRA]** and **[EXIT]** , you will see the commands in the PROFILE.SUB file being executed, followed by the usual A> prompt. From now on, this will always happen when you start up CP/M from your working system disc.)

You may now start up Dr. Logo as follows:

Insert your working system disc (modified as above) into the drive, and start up CP/M by holding down **[SHIFT]** , **[EXTRA]** and **[EXIT]** .

Now insert your Dr. Logo disc (Side 4 of the system discs) and type:

```
LOGO [RETURN]
```

A 'Welcome' message will appear on your screen for a short while. The screen then clears, leaving just a question mark in the top left hand corner. The question mark is a prompt, telling you that Dr. Logo is waiting for you to type something at your keyboard.

2.1 Directing the turtle

In the introduction, we mentioned four of Dr. Logo's primitives: `fd`, `bk`, `rt` and `lt`. Suppose we start by trying out the effect of `fd`.

Before you start a new set of turtle movements on the screen, it is good practice to clear the screen. So the first thing to type is:

```
CS [RETURN]
```

Now, let's see what happens when you type in:

```
fd [RETURN]
```

Instead of seeing the turtle move forward, as you might have expected, you have got the message:

```
Not enough inputs to fd
```

What this tells you is that Dr. Logo also needs to know how far forward. A better instruction would be `fd 60` (followed by `[RETURN]`, of course). If this is typed in, you will see the turtle move forward 60 units from its current position, leaving a line behind it. The number `60` is said to be the Input to the primitive `fd`.

You can make the distance the turtle moves forward any number of units you like. However, for technical reasons, the smallest distance it can move across the screen is two units.

The number of inputs that go with a primitive depends on that primitive: some need many; others need none at all. In fact all the four primitives we have met so far require a number as their input.

You will see that the ? prompt is now nearer the bottom of the screen. Dr. Logo has given you most of the screen to move your turtle around in (referred to as the Graphics Screen) and a smaller text area towards the bottom of the screen (the Text Screen).

Next type in:

```
rt 90 [RETURN]
```

You will see the turtle turns 90 degrees to the right. Follow this with:

```
fd 60 [RETURN]
```

and a second line of the same length is drawn at right angles to the first. Notice that each movement the turtle starts from the position it was left in by the last instruction.

2.1.1 Multiple instructions

Dr. Logo lets you type in a number of instructions like `fd 60` before hitting the Return key. This means you can give the turtle a sequence of movements to make when the Return key is pressed. You could for example, combine the two instructions we have given the turtle so far into one and type:

```
fd 60 rt 90 [RETURN]
```

From the instructions we have already given the turtle, it is easy to see that if the sequence of instructions `fd 60 rt 90` were repeated four times, the result would be a square with sides 60 units long. Dr. Logo has a shorthand for this:

```
repeat 4 [fd 60 rt 90]
```

Clear the screen again by typing `cs [RETURN]`, then try this.

Dr. Logo calls anything between square brackets a List. `[fd 60 rt 90]` is therefore referred to as an Instruction List.

Lists are a feature of LOGO: there are even special primitives that manipulate the contents of lists. But how these operate is beyond the scope of this brief introduction. If you want to know more about list processing, we suggest you read Amsoft publication Soft 160: 'A Guide to LOGO'

2.2 Procedures

We can make the instruction to draw this square even shorter by putting the instructions we need in a unit called a Procedure.

The instructions won't be executed at the time the procedure is set up, but they will be whenever the name of the procedure is given as part of an instruction.

Procedures take the form:

```
to procedure-name
series of instructions on one or more lines
end
```

We can give a procedure any name provided it isn't the name of a primitive and it doesn't start with a number. Dr. Logo will let you know if you do accidentally choose the same name as a primitive.

Suppose we call this particular one Square. The lines to type in to set it up would be:

```
to square [RETURN]
repeat 4 [fd 60 rt 90] [RETURN]
end [RETURN]
```

Once this Procedure Definition has been typed in, it is stored in Dr. Logo's workspace and Dr. Logo will recognise square as part of its vocabulary. Then each time you give the instruction square, it will draw a square of side 60 units on the screen.

In other words, Dr. Logo now treats square as the name of one of its primitives. Another way of thinking about this relationship is to say that primitives are built-in procedures.

The position and orientation of the square that is drawn will depend on the position and orientation of the turtle when the instruction was given. So the sequence of instructions square rt 45 square will result in two squares sharing a common corner, the second inclined at 45 degrees to the first. Clear the screen again; then try it and see.

Any time you want to stop a procedure in mid-execution, press [STOP]

2.2.1 Procedures with inputs

The procedure called Square we set up above always draws a square of side 60 units. A more useful procedure would be one that draws squares of different sizes to order.

Such a procedure would probably need the size of the square as an input, in exactly the same way that the primitive `fd` needed the input `60` to tell Dr. Logo to move the turtle forward 60 units.

The procedure will also have to include something in its definition that shows Dr. Logo what to do with the input you give it. This is called a Local Variable.

The procedure now has the form:

```
to procedure name :variable name
series of instructions
end
```

So the procedure to draw a square of a specified size could be:

```
to squareanysize :side
repeat 4 [fd :side rt 90]
end
```

The Local Variable we have used here is `side`

With this procedure entered into the system, we could type in:

```
squareanysize 150
```

and a square of size 150 units would appear on the screen.

As we described above, the number `150` is the input to the procedure `squareanysize`. There are two further facts to be remembered about inputs to procedures. Firstly, they do not have to be simple numbers: they can equally well be arithmetic expressions; the value of some other variable; or the name of a procedure.

For example, you might have set up a variable called `sqlength`. You would tell the procedure `squareanysize` to take the value of this variable as its input by typing in:

```
squareanysize :sqlength
```

Notice the colon preceding `sqlength`.

Secondly, procedures are by no means limited to one input. You may put as many local variables into the first line of the procedure definition as you want, provided each one is preceded by a single space and a colon. You just have to remember to include as many inputs (again separated by single spaces) in the instruction to execute the procedure as there are local variables in the first line of the procedure definition.

2.3 Variables in LOGO

The colon preceding *variable name* in the above example is crucial. Without it, Dr. Logo will try to interpret the name you give as a procedure — something to do and return the result of. The presence of the colon tells Dr. Logo that what is needed here is the value of the variable.

Each time Dr. Logo encounters *:variable-name* in the first line of the procedure it is executing, it knows that the required value will be the next input in the instruction to run the procedure. If you use *:variable-name* anywhere else, Dr. Logo will expect to find the value already set in its workspace.

There will also be occasions when you need to tell Dr. Logo the name of the object to be processed by either a primitive or a procedure.

An example of this is the primitive *make* which takes two inputs. The first input is the name of a variable, while the second is the value this variable is to have. This value can be a number, an arithmetic expression or the value of another variable, indicated by *:other variable*.

The way to quote a name to Dr. Logo is to precede that name with a quote mark. Thus the instruction to make the variable *side* have the value 60 units is:

```
make "side 60
```

Both colons and quote marks are special characters as far as Dr. Logo is concerned and therefore cannot be used as part of a variable or procedure name.

2.3.1 Local and Global Variables

When we put *:side* on the first line of our procedure definition, we said *side* was a Local Variable but we didn't explain what this meant.

A Local Variable is one whose value is only made available to the procedure itself and to any procedures it calls. Once the procedure is completed, Dr. Logo cannot tell you anything about the value of that variable.

Dr. Logo also understands the idea of Global Variables, the values of which, once set for example by a *make* instruction, are maintained until changed by the program. Such variables can certainly be used in procedures and can be inputs to procedures, but they are not specified in the first line of the procedure definition.

For example, if `side` were a global variable, our procedure to draw a square of a specified size could be:

```
to squareanysize
repeat 4 [fd :side rt 90]
end
```

Notice that this procedure does not require an input.

The sequence of instructions to draw a square of side 60 units would then be:

```
make "side 60
...
squareanysize
```

The current value of a global variable is not lost once the procedure has finished. Some time after issuing the above instructions, you could find out the value of `side` by typing in `:side` after the `?` prompt. The value 60 will appear on the screen (provided you haven't changed this value in the meantime).

2.4 Editing

Procedures can, of course, be edited to correct typing mistakes or to make more basic changes.

If you want to edit a procedure that is already in Dr. Logo's workspace, start by typing `ed "procedure name`. This loads the procedure with this name into the screen editor's buffer, clearing everything else out. Any text or graphics you had on the screen will be lost.

If the procedure you want to edit has just failed when you tried to execute it (and you haven't typed anything else yet), just type `ed`

Use the cursor keys to position the cursor where you want to make a change. Any characters you then type in will be inserted into the procedure definition at the cursor position, while pressing the `[DEL→]` and `[←DEL]` keys will delete the character under the cursor and the one to the left of the cursor, respectively.

The Return key should be pressed at the end of each new line of the procedure, exactly as if you were preparing the procedure from scratch.

Other keys you may find useful while editing are:

[LINE] ([SHIFT] + [EOL])	takes the cursor to the beginning of the line
[EOL]	takes the cursor to the end of the line
[PAGE]	takes the cursor to the bottom of the present page
[ALT] + [PAGE]	takes the cursor to the top of the present page
[DOC] ([SHIFT] + [PAGE])	takes the cursor to the bottom of the procedure or set of procedures you are editing
[ALT] + [DOC]	takes the cursor to the top of the procedure or set of procedures you are editing
[ALT] + [DEL]	erases to the end of the line, starting at the cursor
[COPY] OR [PASTE]	repeats the last line you typed in at the current cursor position

Pressing the [EXIT] key signals to the computer that you have finished editing the old procedure and want to store the new version. Pressing the [STOP] key abandons the edit, leaving the procedure in its old form.

After you have finished editing, Dr. Logo returns you to a full text screen. If you want a full graphics screen, type `fs`. If you want both text and graphics areas on the screen, type `ss`.

2.5 Saving procedures

If you don't save your procedures on disc, they will be lost the moment you switch off.

Dr. Logo uses the instruction `save "filename` to save procedures. This puts the entire contents of its workspace onto the disc.

You have a wide choice in selecting the filename: the only restrictions are that it is not the name of any other file on the disc and that it is no more than eight characters long. However, it is good practice to choose something that reminds you of what the procedures do.

Dr. Logo won't allow you to overwrite an old set of procedures with the `save` instruction: it will point out that you already have a file with that filename. The way to replace an old file with an updated one of the same name is to erase the old file before saving the new one. The lines to type in to do this is:

```
erasefile "filename [RETURN]
save "filename [RETURN]
```

The instruction to restore the procedures to your workspace is:

```
load "filename
```

Postscript

This introduction has only covered just a few of the things Dr. Logo can do. The next chapter tells you about many of the other primitives that Dr. Logo recognises.

Experiment with these both on their own and in some short procedures. With a bit of practice, you should be able to get Dr. Logo to do some quite complex operations.

When you have finished with Dr. Logo, type `bye`

A summary of Dr. Logo primitives

The idea of this chapter is to provide reference material to support your use of the Dr. Logo programming language.

It is aimed at the relative newcomer to the LOGO language. Appendix I gives the full list of the primitives supported on the PCW8256.

The following lists of commands are designed to help you find a suitable primitive for what you want to do and then use it either directly or in a procedure. Examples are given where possible.

These lists are by no means exhaustive. If you are interested in getting Dr. Logo to carry out more complex instructions, you should refer to Soft 160: 'A Guide to LOGO'.

3.1 Turtle graphics

<code>bk <i>n</i></code>	moves the turtle <i>n</i> steps back in the opposite direction to that in which it is pointing. For example, <code>bk 60</code> moves the turtle back 60 steps.
<code>fd <i>n</i></code>	moves the turtle <i>n</i> steps forward in the direction it is pointing. For example, <code>fd 60</code> moves the turtle forward 60 steps.
<code>home</code>	returns the turtle to its home position.
<code>ht</code>	hides the turtle , making it invisible. This both speeds and clarifies drawing.
<code>lt <i>n</i></code>	rotates the turtle <i>n</i> degrees anticlockwise (to the left). For example, <code>lt 60</code> turns the turtle left through 60°.
<code>pd</code>	puts the turtle's pen down so that it resumes drawing.
<code>pe</code>	makes the turtle's pen an eraser , erasing any lines it passes over.
<code>pu</code>	picks the turtle's pen up so that it stops drawing.
<code>rt <i>n</i></code>	rotates the turtle <i>n</i> degrees clockwise (to the right). For example, <code>rt 60</code> turns the turtle right through 60°.
<code>seth <i>n</i></code>	turns the turtle round so that it is set to an absolute heading based on zero vertically up. (<i>n</i> is quoted in degrees.) For example, <code>seth 90</code> turns the turtle so that it points to the right.
<code>setpos [<i>n</i> <i>m</i>]</code>	moves the turtle to a set position specified by <i>n</i> and <i>m</i> . For example, <code>setpos [30 50]</code> moves the turtle to the position with x-coordinate 30 and y-coordinate 50.

setx <i>n</i>	moves the turtle horizontally until it has a set x-coordinate specified by <i>n</i> . For example, setx 30 moves the turtle across the screen until the x-coordinate of its position is 30.
sety <i>n</i>	moves the turtle vertically until it has a set y-coordinate specified by <i>n</i> . For example, sety 50 moves the turtle up or down the screen until the y-coordinate of its position is 50.
st	shows the turtle (if hidden before).
tf	gets the computer to specify the current state of the turtle in terms of its position, heading and visibility — the Turtle Facts .
towards [<i>n m</i>]	turns the turtle round so that it points towards the position on the screen specified by <i>n</i> and <i>m</i> . For example, towards [30 50] turns the turtle round so that it points towards the spot with x-coordinate 30 and y-coordinate 50.

3.2 Graphics screen

clean	cleans the graphics screen without affecting the turtle.
cs	cleans the graphics screen and puts the turtle back to its original position.
dot [<i>n m</i>]	puts a dot at the position specified by <i>n</i> and <i>m</i> . For example, dot [30 50] puts a dot on the screen at the spot with x-coordinate 30 and y-coordinate 50.
fence	fences the turtle in, limiting it to the visible part of the graphics screen.
fs	makes over the full screen to graphics.
setscrunch <i>n</i>	sets the graphics screen's aspect ratio to <i>n</i> . <i>n</i> can take any value between 0.1 and 10. The preset value is 0.468.
setsplit <i>n</i>	sets the number of text lines in a split screen to <i>n</i> . For example, setsplit 10 sets the number of text lines on the screen to 10.
sf	gets the computer to specify the current state of the screen — the Screen Facts .
ss	puts up the standard split screen — part graphics, part text.
window	allows the turtle the biggest possible window in which to move. This primitive therefore allows the turtle to venture outside the visible screen area after a wrap or fence instruction.
wrap	wraps the screen round so that the turtle reappears on the opposite side of the graphics screen when it attempts to cross a boundary.

3.3 Text screen

ct	clears all the text in the window that currently contains the cursor, leaving the cursor in its top left-hand corner.
cursor	displays the cursor's position within the text screen in terms of a column number and a line number.

pr [a b] **prints** a b... on the text screen, without brackets and following the last element of the list with a carriage return. For example, pr [a b c] causes Dr. Logo to display a b c on the screen.

setcursor [n m] **sets** the position of the **cursor** in the text screen to column *n* and line *m*. For example, setcursor [35 14] moves the cursor to column 35 of line 14.

setsplit *n* **sets** the number of text lines in a **split** screen to *n*. For example, setsplit 10 sets the number of text lines on the screen to 10.

show [a b ...] **shows** a b... on the text screen, with brackets and putting a carriage return after the final bracket. For example, show [a b c] causes Dr. Logo to display [a b c] on the screen.

ss puts up the **standard split** screen – part graphics, part text.

ts selects a full **text screen** (no graphics area).

type [a b...] **types** a b... on the text screen, without brackets and with no carriage return after the last element in the list. For example, type [a b c] causes Dr. Logo to output a b c

3.4 Variables

erall **erases all** procedures and variables from the workspace.

ern [a b.] **erases** the **named** variables. For example, ern [side size] erases the variables side and size

(local "a "b...) **makes** the named variables **local** to (ie only accessible from) the current procedure or the procedures it calls. For example, (local "side "size) makes the variables side and size local to the current procedure.

make "variable *a* **makes** the current value of *variable* be *a*. For example, make "side 50 makes the current value of side 50.

nodes outputs the number of free locations in the workspace (**nodes**).

po "a **prints out** the value of the specified variable. For example, if side has the value 50, po "side would have the output 50

poall **prints out** the definitions of **all** the procedures and variables in the workspace.

pons **prints out** the **names** and values of all the global variables in the workspace.

recycle reorganises the workspace, clearing out any garbage.

thing "a outputs the value of the **thing** *a*. For example, if side had the value 50, thing "side would have the output 50

3.5 Arithmetic operations

arctan n	outputs in degrees the angle whose tangent is n . For example, arctan 1 would have the output 45
cos n	outputs the cosine of the angle n degrees. For example, cos 60 would have the output 0.5
int n	outputs the integer portion of the number n . For example, int 1.33 would have the output 1
quotient $n\ m$	outputs the result of the integer division of n by m . For example, quotient 14 4 would have the output 3
random n	outputs a random positive integer less than n (or zero).
remainder $n\ m$	outputs the remainder when n is divided by m . For example, remainder 7 3 would have the output 1
round n	rounds off n to the nearest integer. For example, round 3.33 would have the output 3, but round 3.5 would have the output 4
sin n	outputs the sine of the angle n degrees. For example, sin 30 would have the output 0.5
+ $a\ b$ or $a+b$	outputs the sum of a and b . For example, both + 2 2 and 2+2 would have the output 4
- $a\ b$ or $a-b$	outputs the result of subtracting b from a . For example, both - 10 5 and 10-5 would have the output 5
* $a\ b$ or $a*b$	outputs the result of multiplying a by b . For example, both * 4 6 and 4*6 would have the output 24
/ $a\ b$ or a/b	outputs the result of dividing a by b . For example, both / 26 5 and 26/5 would have the output 5.2

3.6 Logical operations

and $a\ b$	outputs TRUE if statements a and b are both true: otherwise FALSE. For example, and (3<4) (7>4) would have the output TRUE
not a	outputs TRUE if statement a is not true and FALSE if it is true. For example, not (3=4) would have the output TRUE
or $a\ b...$	outputs TRUE if one or other of the statements is true and FALSE if none of these are true. For example, or (3=4) (2=2) would have the output TRUE, but or (3=4) (2=1) would have the output FALSE
= $a\ b$ or $a=b$	outputs TRUE if a and b are equal : otherwise FALSE. For example, = "yes "yes would have the output TRUE but 1=2 would have the output FALSE
> $a\ b$ or $a>b$	outputs TRUE if a is greater than b : otherwise FALSE. For example, > 19 20 would have the output FALSE but 20>19 would have the output TRUE
< $a\ b$ or $a<b$	outputs TRUE if a is less than b : otherwise FALSE. For example, < 19 20 would have the output TRUE but 20<19 would have the output FALSE

3.7 Procedures

.contents	displays all the names and symbols Dr. Logo currently recognises.
ed "procedure-name	prepares to edit the specified procedure.
edall	prepares to edit all procedures in the workspace.
end	marks the end of a procedure definition (stands on its own on the last line).
er "procedure-name	erases the specified procedure. For example, er "square would erase the procedure called square
erall	erases all procedures and variables from the workspace.
po "procedure-name	prints out the definition of the specified procedure. For example, po "square would display the definition of the procedure called square
poall	prints out the definitions of all the procedures and variables in the workspace.
pops	prints out the names and definitions of all the procedures in the workspace.
pots	prints out the titles and inputs of all the current procedures.
text "procedure-name	displays the text of the specified procedure definition
to	indicates the beginning of a procedure definition.

3.8 Flow of control

bye	exits from the current session of Dr. Logo.
catch "name a	catches the errors and special conditions specified by a that occur during execution of the instruction list and have been identified by a throw instruction with the same name.
co	continues after a program enforced pause.
error	outputs a list whose elements describe the most recent error .
go "word	goes to the position in the current procedure labelled <i>word</i> and executes the following line.
if a instruction-list1	executes <i>instruction-list1</i> if statement <i>a</i> is true: otherwise it goes on to the next instruction. For example, if a>b [pr [a is bigger]] will output a is bigger if a is bigger than b
label "word	labels the line to be executed after a go "word instruction.
op a	makes <i>a</i> the output of the procedure and exits from the procedure at that point.
pause	makes the execution of the current procedure pause (restored by co).
repeat n [instruction-list]	repeats the instruction list <i>n</i> times. For example, repeat 4 [fd 30 rt 90] makes the turtle move 30 steps forward and then turn right a total of four times.
run [instruction-list]	executes the instruction list.
stop	stops the execution of the current procedure.
throw "name	works with a catch instruction of the same name to identify a special condition. It then throws the procedure back to the line following the catch command.

3.9 Word and list processing

- `ascii "word` or `ascii [a b...]` outputs the **ASCII** value of the first letter of *word* or the first character in the list. For example, `ascii "go` would have the output 103
- `bf "word` or `bf [a b...]` outputs all **but the first** letter of *word* or the first element of the list. For example, `bf "smiles` would have the output `miles`; `bf [1 2 3]` would have the output `[2 3]`
- `bl "word` or `bl [a b...]` outputs all **but the last** letter of *word* or the last element of the list. For example, `bl "smiles` would have the output `smile`; `bl [1 2 3]` would have the output `[1 2]`
- `char n` outputs the **character** whose ASCII value is *n*. For example, `char 83` would have the output `s`
- `count "word` or `count [a b...]` **counts** the number of letters in *word* or the number of elements in the list. For example, `count "smiles` would have the output `6`; `count [1 2 3]` would have the output `3`
- `first "word` or `first [a b...]` outputs the **first** letter of *word* or the first element of the list. For example, `first "smiles` would have the output `s`; `first [1 2 3]` would have the output `1`
- `fput "a "word` outputs a new word made by **putting a first**, attached to the front of *word*. For example, `fput "s "miles` would have the output `smiles`
- `fput a [b c...]` outputs a new list made by **putting a** as the **first** element. For example, `fput 1 [2 3 4]` would have the output `[1 2 3 4]`
- `item n "word` or `item n [a b...]` outputs the *n***th item** (letter) of *word* or the *n***th** item of the list. For example, `item 2 "smiles` would have the output `m`; `item 2 [1 2 3]` would have the output `2`
- `last "word` or `last [a b...]` outputs the **last** letter of *word* or the last element of the list. For example, `last "smiles` would have the output `s`; `last [1 2 3]` would have the output `3`
- `lc "word` outputs the given word with any upper case characters converted to **lower case**. For example, `lc "SunShine` would have the output `sunshine`
- `(list a b...)` outputs the **list** `[a b...]`. For example, `(list 1 2 3)` would have the output `[1 2 3]`
- `lput "word1 "word2` **puts** the first word **last**, thus making the new word `word2word1`. For example, `lput "cup "egg` would have the output `eggcup`
- `lput "z [a b...]` **puts** the first list **last**, thus making the new list `[a b... z]`. For example, `lput 4 [1 2 3]` would have the output `[1 2 3 4]`
- `se "word1 "word2...` outputs a list with the elements `word1, word2...`, making a **sentence** out of them. For example, `se "pork "beef "lamb` would have the output `[pork beef lamb]`
- `se [a1 b1...] [a2 b2...]` outputs `[a1 b1... a2 b2...]`. For example, `se [red orange yellow] [green blue]` would have the output `[red orange yellow green blue]`

shuffle [*a b...*] outputs a list that contains the elements of the input list but **shuffled**. For example, `shuffle [1 2 3 4]` could have the output `[2 4 3 1]`

`uc "word"` outputs the given word entirely in **upper case** (capital) letters. For example, `uc "SunShine"` would have the output `SUNSHINE`

`word "word1" "word2"` outputs the new **word** `word1word2`. For example, `word "sun" "shine"` would have the output `sunshine`

3.10 Disc handling

`change` "*new-filename*" "*old-filename*" **changes the name of a file** on the current disc. For example, `change "box" "square"` would change the name of the procedure currently known as `square` to `box`

`dir` [*filename*] outputs a **directory** (list) of the Dr. Logo filenames on a drive. The primitive accepts the question mark form of wildcard. For example, `dir` would output all the files on the default drive; `dir "a:"` would output all the files on Drive A; `dir "p???????"` would output the names of all files with filenames beginning with `p` on the default drive.

`erasefile` "*filename*" **erases the file** with the specified filename from the directory of the current disc. For example, `erasefile "myproc"` would erase the file `myproc`

`load` "*filename*" **loads** (ie reads in) the named file. For example, `load "myproc"` would read in the file called `myproc`

`save` "*filename*" **saves** the current contents of the workspace by writing it to disc and stores it under the name *filename*. For example, `save "myproc"` would store the current contents of the workspace as a file called `myproc`

3.11 Taking data from the keyboard

`rc` **reads** the first **character** typed at the keyboard.

`rl` **reads** in a list made up of the **line** of characters typed in at the keyboard and terminated by the Return key.

`rq` **reads** in a word or set of words (a **quote**) typed in at the keyboard and terminated by the Return key.

3.12 Controlling the printer

`copyon` starts echoing screen text on the printer.

`copyoff` stops echoing screen text on the printer.

3.13 Handling picture files

`dirpic [filename]` outputs a **directory** (list) of the **picture files** on a drive. The primitive accepts the question mark form of wildcard. For example, `dirpic "a:` would output all the picture files on Drive A; `dirpic "p???????` would output the names of all the picture files on the default drive whose filenames begin with `p`.

`loadpic filename` re-creates a design by **loading** the named **picture file** into memory and displaying it on the graphics screen. For example, `loadpic "mypic` would display the design stored in the file `mypic`.

`savepic filename` **saves** the contents of the graphics screen as a **picture file**. For example, `savepic "mypic` would save the current graphics screen as the file `mypic`.

br **or** **not** **atsb** **pablt** **LC**

Appendix I

Primitives supported on the PCW8256

and	erasefile	make	repeat	uc
arctan	erasepic	memberp	rerandom	
ascii	ern		rl	watch
	error	namep	round	where
bf	.examine	nodes	rq	window
bk		noformat	rt	word
bl	fd	not	run	wordp
bye	fence	notrace		wrap
	fill	nowatch	save	
catch	first	numberp	savepic	
change!f	fput		se	
char	fs	op	setcursor	
clean		or	setd	
co	glist	.out	seth	
.contents	go		setpc	
copyoff	gprop	pause	setpen	
copyon		pd	setpos	
cos	home	pe	setscrunch	
count	ht	piece	setsplit	
cs		plist	setx	
ct	int	po	sety	
cursor	item	poall	sf	
	if	pons	show	
defaultd	.in	pops	shuffle	
define		pots	sin	
.deposit	keyp	pprop	ss	
dir		pps	st	
dirpic	label	pr	stop	
dot	last	pu		
dotc	lc	px		
	list		text	
ed	listp	quotient	tf	
edall	load		thing	
edf	loadpic	random	throw	
emptyp	local	rc	to	
end	lput	recycle	towards	
er	lt	remainder	trace	
erall		remprop	ts	
			type	

Appendix II

Dr. Logo error messages

General

Message	Suggested action
I don't know how to <i>name</i>	Check spelling of <i>name</i>
Primitive not implemented	Try another way of getting desired result
Can't <i>action</i> from the editor	Wait until you get back into text mode
I can't <i>action</i> while loading	Wait
Can't divide by zero	Check the sum you want to do
Turtle out of bounds	Check your instruction
Out of space	Issue a recycle instruction to tidy up the workspace
Too few items in <i>list</i>	Check either your instruction or your list

Procedures

Message	Suggested action
<i>name</i> is a primitive	Choose another name
Not enough inputs to <i>procedure name</i>	Check the format of your instruction
<i>variable</i> has no value	Modify your program so that this is set
<i>variable</i> is not true or false	Modify your program so that this is set
The word is too long	You have been too ambitious in adding together strings of characters: modify your program
Number too big	Modify what you have asked Dr. Logo to do
<i>variable</i> is not a parameter	Check the definition of the procedure
I don't know what to do with <i>name</i>	Check your program
Can't find label <i>name</i>	Check your program
Can't find catch for <i>name</i>	Check your program
)without(Check your program for unmatched parentheses
if wants []'s around instruction list	Check your program for unmatched brackets
<i>procedure-name</i> doesn't like <i>name</i> as input	Check the definition of the procedure
<i>procedure name</i> didn't output	Check the definition of the procedure

Discs

Message

I'm having trouble with the disk
Disk is full
File already exists

File not found
Disk is write protected
The file is write protected
I can't find that drive
I can't find the disk drive
You need at least 2 drives to do this
Source and Destination diskettes differ

Suggested action

Try again
See if you can erase some files
Either erase the existing file or choose a different name
Check the directory
Write enable or use another disc
Allow read-write access to the file
Check your instruction
Check your instruction
Choose a different operation
Check your instruction

Index

- Arithmetic, 1
 - primitives, 14
 - Bye, 10
 - Changing procedures, 8
 - Disc handling
 - primitives, 17
 - Editing, 8
 - finish, 9
 - keys, 9
 - Errors, 21
 - Exit, 10
 - Experiment, 1
 - Filenames, 9
 - Finish editing, 9
 - Flow of control
 - primitives, 15
 - Global variables, 7
 - Graphics screen, 4, 9
 - primitives, 12
 - Inputs
 - number of, 4
 - to primitive, 3
 - to procedures, 5
 - Instructions
 - list, 4
 - multiple, 4
 - Keyboard
 - for editing, 9
 - primitives, 17
 - Leaving Dr. Logo, 10
 - List, 4
 - List processing
 - primitives, 16
 - Local variables, 6, 7
 - Logical operations
 - primitives, 14
 - Primitives, 1
 - arithmetic, 14
 - disc handling, 17
 - flow of control, 15
 - full list, 19
 - graphics screen, 12
 - keyboard, 17
 - list processing, 16
 - logical operations, 14
 - printer, 18
 - summary, 11
 - text screen, 12
 - turtle graphics, 11
 - variables, 13
 - word processing, 16
 - Printer
 - primitives, 18
 - Procedures, 5
 - changing, 8
 - editing, 8
 - name, 5
 - number of inputs, 6
 - primitives, 15
 - saving, 9
 - Prompt, 4
 - Screen, 1
 - graphics, 4, 9
 - primitives, 12
 - text, 4, 9
 - Split screen, 9
 - Starting Dr. Logo, 1
 - Stop, 10
 - Subroutines
 - see Procedures, 5
 - System discs, 3
 - Text screen, 4, 9
 - primitives, 12
-

Troubleshooting, 21

Turtle, 1

graphics primitives, 11

moving, 3

rotating, 4

Variables

duration of value, 8

global, 7

local, 6, 7

primitives, 13

value of, 7

Welcome, 3

Word processing

primitives, 16

Workspace, 5

Two-Drive Operation

Using the PCW8512 (or PCW8256 with second FD-2 drive fitted)

Introduction

If you are operating a 2-drive system, the on-line disc storage capacity of the PCW is increased by 1 Megabyte (720K formatted). The top disc drive in the monitor is known as Drive A and the bottom drive is known as Drive B.

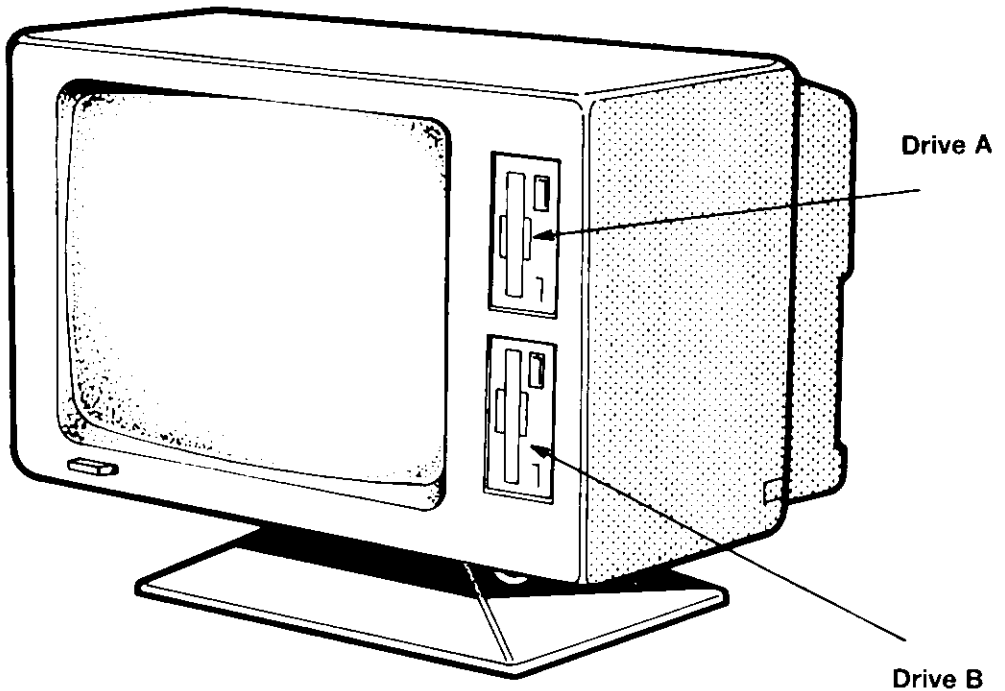

Discs and drives

NOTE: Drive B writes data onto discs in what's known as 'double density' format. Note that from here on in the manual, we shall refer to discs which are to be written-to in Drive B as 'CF-2DD's. (Standard discs will be referred to as 'CF-2's.)

The way that Drive B stores information on a disc is different from that of Drive A. On Drive B, not only is there double the number of tracks on each side of the disc, but in addition, Drive B is able to access both sides of the disc without turning it over.

Note therefore, that a disc to be used in Drive B may only be inserted the following way round:

TYPE OF DISC	INSERTION INTO DRIVE B
CF-2 (originally created in DRIVE A)	The side that you wish to read must be nearest the screen.
CF-2DD (originally created in DRIVE B)	Side 1 must ALWAYS be nearest the screen.

IMPORTANT - A CF-2DD disc created in Drive B can NOT be used in Drive A

Although discs are not freely interchangeable between Drive A and Drive B, you may use Drive B to carry out operations which read (but NOT write) to a standard CF-2 disc originally created in Drive A.

OPERATION	DRIVE TO BE USED		DISC TO BE USED
	DRIVE A	DRIVE B	
Operations which ONLY read from a disc	POSSIBLE	POSSIBLE	CF-2 disc originally created in Drive A
	NOT POSSIBLE	POSSIBLE	CF-2DD disc originally created in Drive B
Operations which write (or read AND write) to disc	POSSIBLE	NOT POSSIBLE	CF-2 disc originally created in Drive A
	NOT POSSIBLE	POSSIBLE	CF-2DD disc originally created in Drive B

If you try to read or write a disc in an unsuitable drive, you will receive an error message such as 'Disc unsuitable' or some other less-friendly CP/M error message such as 'Disc I/O' or 'File non-recoverable'.

2-drive system

In addition to the obvious extra capacity afforded to text files during word processing, CP/M data-processing programs will also benefit from a 2-drive system, enabling the PCW to handle much larger (up to an additional 720K) data files. The CP/M software packages themselves should contain installation and operating instructions for a 2-drive system.

Certain suites of programs are so extensive that they won't, in their entirety, fit onto one or even two 180K sides of a standard CF-2 disc. Such suites can happily be installed onto one CF-2DD obviating the need to constantly insert and remove discs to access the required program.

Similarly, you may care to note that the CP/M utility programs package supplied on three separate disc-sides with your standard PCW may all be installed onto one CF-2DD. From then on, you can start up CP/M with your CF-2 in Drive A as before, and then call up any CP/M utility off the CF-2DD in Drive B.

Formatting discs for Drive B

CF-2DD discs for Drive B are formatted using the DISCKIT program on Side 2 of the system disc. After starting up CP/M, load DISCKIT. After removing the disc from the drive and pressing any key, you will see:

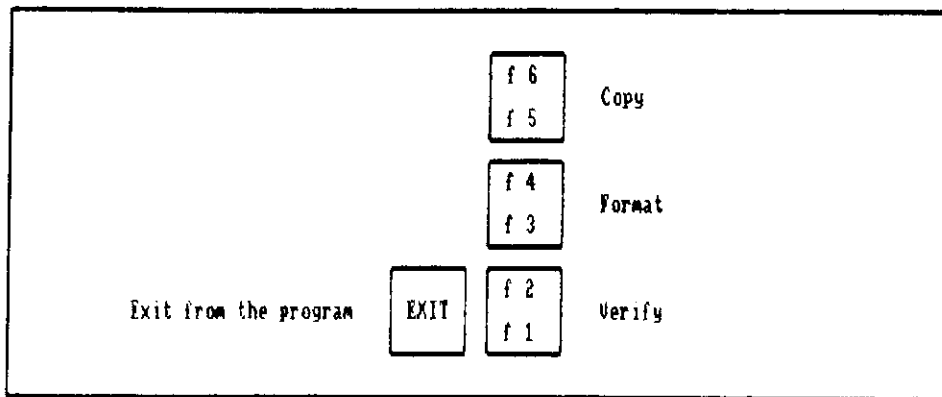

Select the **Format** option by pressing **f3**.

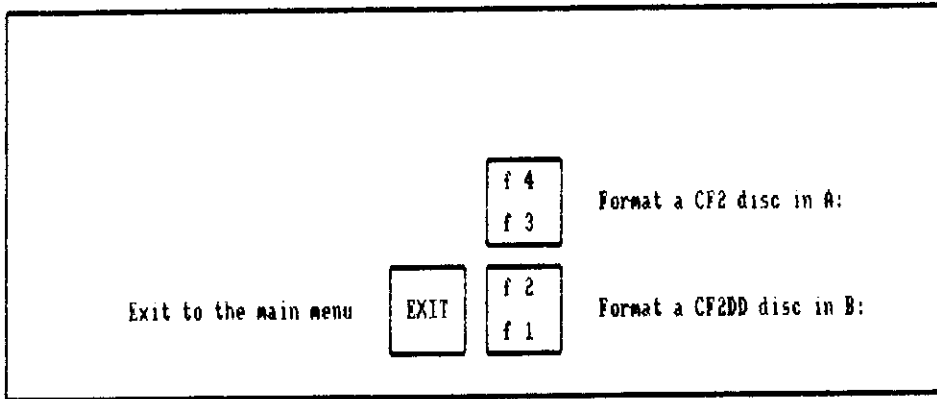

Now insert the CF-2DD disc into Drive B and press **f1**. From then on, simply follow the instructions on the screen, and the entire disc will be formatted (tracks 0 to 159).

If you have not write-enabled the disc to be formatted (by closing the write-protect hole) you will receive the appropriate error message.

Using Drive B with CP/M

Like Drive A and Drive M you may set the default drive to B by simply typing:

B:

(The current default drive is indicated by the **A>** **B>** or **M>** prompt.)

Alternatively, you may read or write to Drive B without altering the default setting. This is achieved by simply adding the prefix **B:** to the program or filename.

For example, to load a program from Drive B (while the default setting is A) you may type

B:HELP

Drive B directory

An CF-2DD disc in Drive B may contain up to 256 directory entries (as opposed to 64 entries per side on Drive A and Drive M). To examine Drive B directory, simply type **DIR B:** (or just **DIR** if Drive B is the default drive).

Disc files

Drive B provides an additional 720K of readily-accessible disc storage space. Files can be freely transferred between Drive A, Drive B and Drive M.

Examples (using PIP):

PIP A:=B:FILENAME	...copies a file from B to A (giving it the same filename)
PIP B:=M:*. *	...copies all files from M to B (? and * wildcards may be used)
PIP B:NEWNAME=A:OLDNAME	...copies a file from A to B (renaming it in the process)
PIP B:FILENAME=CON:	...takes input from the keyboard console and writes it to a file on B

File sizes

Drive A and Drive M partition the disc into blocks of 1K (minimum) per directory entry. To examine the file sizes, type:

```
DIR [SIZE]
```

Notice how the DIR [SIZE] command not only sorts and displays the directory but also gives you information on the amount of bytes, blocks, records (which are 128 byte portions of blocks), files, and directory entries used.

On Drive B the disc is partitioned into blocks of 2K (minimum) per directory entry. To illustrate this point, copy a small (1K) file from Side 2 of the system disc in Drive A onto Drive B and then compare the sizes of the two 'identical' files:

```
DIR A:KEYS.WP [SIZE]
```

...then:

```
PIP B:=A:KEYS.WP
```

...then:

```
DIR B:KEYS.WP [SIZE]
```

Files longer than 16K

Note that one directory entry is allocated to every 16K of a file (although only a single entry will appear in the displayed directory).

SHOW

The SHOW command will enable you to compare some of the attributes of Drive A with Drive B.

To discover the amount of RW (Read/Write) space on a disc, type:

```
SHOW      ....or....  SHOW B:
```

To discover the number of free directory entries, type:

```
SHOW [DIR]      ....or....  SHOW B:[DIR]
```

To examine the drive characteristics, type:

```
SHOW [DRIVE]    ....or....  SHOW B:[DRIVE]
```

Copying using DISCKIT

In addition to formatting (described previously), DISCKIT may be used to make exact copies of discs. After starting up CP/M and loading DISCKIT, select the Copy option by pressing . You will then receive the following options:

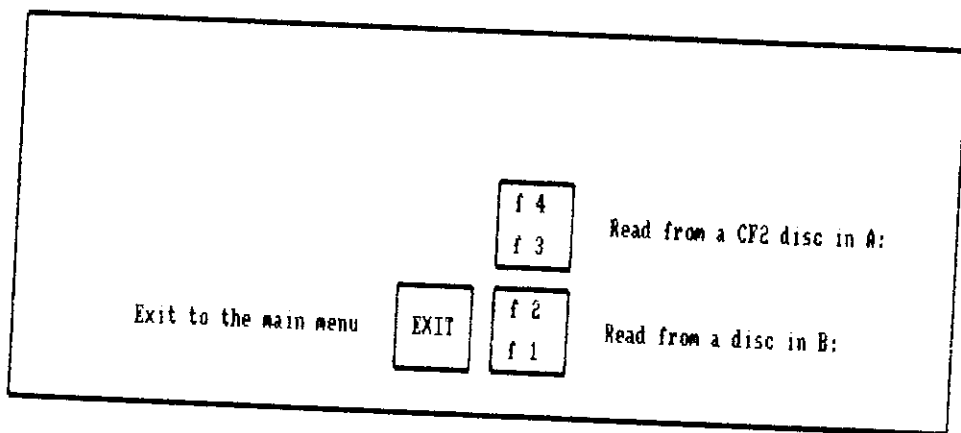

Select which drive to read from (by pressing or). If you have pressed , you will receive the following options:

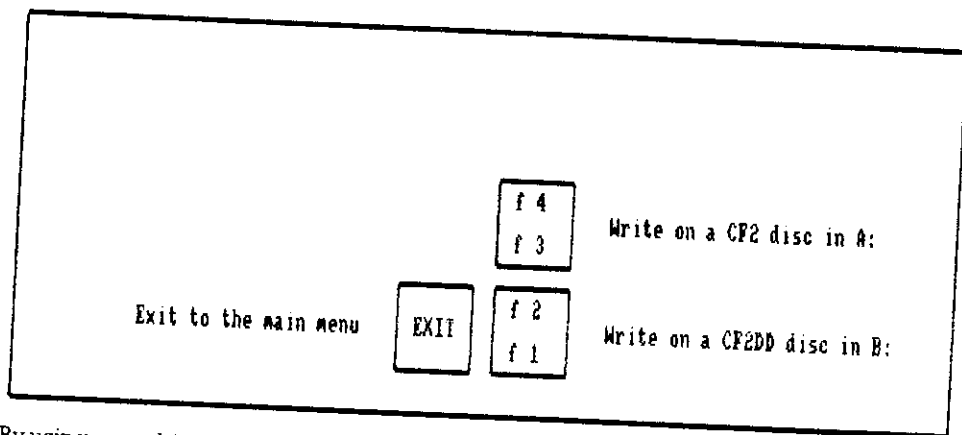

By using a combination of these options, you may:

copy one CF-2 to another CF-2 (by periodically swapping between discs) in Drive A.

then

copy one CF-2DD to another CF-2DD (by periodically swapping between discs) in Drive B.

then

copy one CF-2 in Drive B to another CF-2 in Drive A (without the need to periodically swap between discs).

You may NOT copy an CF-2DD disc to an CF-2 disc under any circumstances. Attempting to do so will result in an error message.

When copying an CF-2 using two drives, make sure that the disc to read is in Drive B and the disc to write is in Drive A.

If you have not write-enabled the disc to be copied onto (by closing the write-protect hole) you will receive the appropriate error message.

Verifying

DISCKIT may be used to verify a disc (CF-2) in Drive A or a disc (CF-2 or CF-2DD) in Drive B. After starting up CP/M and loading DISCKIT, select the Verify option by pressing *fr* , then follow the instructions on the screen.

Using Drive B with LocoScript

When operating LocoScript, Drive B may be considered as a non-volatile storage medium for up to an additional 706K of files.

NOTE - the maximum size of a document that may be edited in LocoScript is determined by the amount of free space in Drive M. The presence of Drive B does NOT increase that figure.

Start up LocoScript in Drive A (with no disc inserted in Drive B). Within the Disc management screen, you will see:

```
Drive B:      empty
 0k used  0k free  0 files
```

This means that LocoScript has detected that Drive B is fitted to the system but no disc is inserted in the drive. Now insert a formatted blank CF-2DD disc into Drive B and press *fr* (Note that you must always press *fr* after you've removed or inserted a disc :

You will now see:

```
Drive B:
0k used 706k free 0 files
group 0 0k group 4 0k
group 1 0k group 5 0k
group 2 0k group 6 0k
group 3 0k group 7 0k
```

Although no files yet exist on Drive B, the amount of free disc space will be displayed together with groups 0 to 7. (As with Drives A and M you may RENAME the groups using the `fs` function.)

Creating a file on Drive B

Let us, for example, create a new document in group 0 on Drive B.

Hold down `[SHIFT]` and press the Right Cursor key twice. The top cursor will be positioned over group 0 in the box headed Drive B:. Now press the `C` key (for Create) and you will receive the following menu:

```
Create document
Name: DOCUMENT.000
Group: group 0
Drive: B
```

This menu tells you the group and drive on which the file will be created as well as giving the file an arbitrary name - DOCUMENT.000. Let's choose a different name. (As this is a text file for Drive B) type in:

B.TXT ...and press `[ENTER]`

You will now be able to create the document with your chosen filename (which will be displayed at the top of the screen). Type the following into the file:

This is a test file on Drive B group 0....

Now press `[EXIT]` to finish editing. You will receive the following menu:

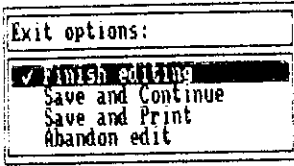

Confirm that you wish to `Finish editing` by pressing `[ENTER]`

After the file is stored, the top and bottom cursors will remain in the selected drive, group, and file locations, and you may thereafter perform any LocoScript function on the newly created file.

Copying a file

We will now copy the file `TEMPLATE . STD` from Drive M to Drive B.

Press the Right Cursor key until the bottom cursor is positioned over the filename `TEMPLATE . STD` in the box headed `M : LETTERS`.

Start the `Copy` operation by pressing `[F3]`. (The name of the file to copy will be confirmed at the top left hand corner of the screen.)

You must now move the cursor to where you require the file to be copied. Hold down `[SHIFT]` and press the Left Cursor key until the top cursor is positioned over group `0` in the box headed `Drive B :`. Now press `[ENTER]` and you will receive a menu displaying all the copying details you have just selected. Confirm this by pressing `[ENTER]` again, and the copy will go ahead. If you wish to abort the copying operation at any time, press `[CAN]`.

After the file is copied, the top and bottom cursors will remain in the selected drive, group, and file locations, and you may thereafter perform any LocoScript function on the newly copied file.

End user program licence agreement

NOTICE TO USER – PLEASE READ THIS NOTICE CAREFULLY. DO NOT OPEN THE DISKETTE PACKAGE UNTIL YOU HAVE READ THIS LICENCE AGREEMENT.

OPENING THE DISKETTE PACKAGE INDICATES YOUR AGREEMENT TO BE BOUND BY THESE TERMS AND CONDITIONS.

1. Definitions

In this Licence Agreement, the terms:

1. DRI means DIGITAL RESEARCH (CALIFORNIA) INC., P.O. Box 579, Pacific Grove, California 93950, owner of the copyright in, or authorised licensor of, the program.
2. Machine means the single microcomputer on which you use the program. Multiple CPU systems require additional licences.
3. Program means the set of programs, documentation and related materials in this package, together with all ancillary updates and enhancements supplied by DRI to you regardless of the form in which you may subsequently use it, and regardless of any modification which you make to it.
4. AMSTRAD means AMSTRAD CONSUMER ELECTRONICS PLC., Brentwood House, 169 Kings Road, Brentwood, Essex CM14 4EF.

You assume responsibility for the selection of the program to achieve your intended results, and for the installation, use and results obtained from the program.

2. Licence

You may

1. Use the program on a single machine.
2. Copy the program into any machine readable or printed form for backup or modification purposes in support of your use of the program on a single machine. You may make up to three (3) copies of the program for such purposes. (Certain programs, however, may include mechanisms to limit or inhibit copying. They are marked 'copy protected'). Copying of documentation and other printed materials is prohibited. Disassembly of code is prohibited.
3. Modify the program and/or merge it into another program for your use on the single machine. (Any portion of this program merged into another program will continue to be subject to the terms and conditions of this Agreement).
4. Transfer the program and licence to another party if you notify DRI of name and address of the other party and the other party agrees to a) accept the terms and conditions of this Agreement, b) sign and forward to DRI a copy of the registration card and c) pay the then current transfer fee. If you transfer the program, you must at the same time either transfer all copies, including the original, whether in printed or machine readable form to the same party, or destroy any copies not transferred; this includes all modifications and portions of the program contained or merged into other programs.

You must reproduce and include the copyright notice on any copy, modification or portion merged into another program.

EACH DISKETTE IS SERIALISED, AND YOU MAY NOT USE, COPY, MODIFY, TRANSFER, OR OTHERWISE MAKE AVAILABLE TO ANY THIRD PARTY, THE PROGRAM, OR ANY COPY, MODIFICATION OR MERGED PORTION, IN WHOLE OR IN PART, EXCEPT AS EXPRESSLY PROVIDED FOR IN THIS LICENCE AGREEMENT.

IF YOU TRANSFER POSSESSION OF ANY COPY, MODIFICATION OR MERGED PORTION OF THE PROGRAM TO ANOTHER PARTY, YOUR LICENCE IS AUTOMATICALLY TERMINATED.

3. Term

The licence is effective until terminated. You may terminate it at any other time by destroying the program together with all copies, modifications and merged portions in any form. It will also terminate upon conditions set forth elsewhere in this Agreement or if you fail to comply with any term or condition of this Agreement. You agree upon such termination to destroy the program together with all copies, modifications and merged portions in any form.

4. Limited warranty

THE PROGRAM IS PROVIDED 'AS IS'. NEITHER DRI NOR AMSTRAD MAKE ANY WARRANTY OF ANY KIND, EITHER EXPRESSED OR IMPLIED, INCLUDING, BUT NOT LIMITED TO THE IMPLIED WARRANTIES OF MERCHANTABILITY AND FITNESS FOR A PARTICULAR PURPOSE. THE ENTIRE RISK AS TO THE QUALITY AND PERFORMANCE OF THE PROGRAM IS WITH YOU. SHOULD THE PROGRAM PROVE DEFECTIVE, YOU (AND DRI OR AMSTRAD) ASSUME THE ENTIRE COST OF ALL NECESSARY SERVICING, REPAIR OR CORRECTION.

Neither DRI nor AMSTRAD warrant that the functions contained in the program will meet your requirements or that the operation of the program will be uninterrupted or error free.

However, AMSTRAD warrants the diskette on which the program is furnished, to be free from defects in materials and workmanship under normal use for a period of ninety (90) days from the date of delivery to you as evidenced by a copy of your receipt.

5. Limitations of remedies

AMSTRAD's entire liability and your exclusive remedy shall be the replacement of any diskette not meeting this 'Limited Warranty' and which is returned to AMSOFT with a copy of your receipt.

IN NO EVENT SHALL DRI OR AMSTRAD BE LIABLE FOR ANY DAMAGES, INCLUDING ANY LOST PROFITS, LOST SAVINGS, OR OTHER SPECIAL INDIRECT OR CONSEQUENTIAL DAMAGES, EVEN IF DRI OR AMSTRAD HAS BEEN ADVISED OF THE POSSIBILITY OF SUCH DAMAGES, OR FOR ANY CLAIM BY ANY OTHER PARTY.

6. Registration card

DRI may from time to time update its programs. Updates will be provided to you only if a properly signed registration card is on file at DRI's main office or an authorised registration card recipient. DRI is not obligated to make any program updates, or to supply any such updates to you.

7. General

You may not sublicense, assign or transfer the licence or the program except as expressly provided in this Agreement. Any attempt otherwise to sublicense, assign or transfer any of the rights, duties, or obligations hereunder is void.

This Agreement shall be governed by and construed in accordance with the laws of England.

Should you have any questions concerning this Agreement, you may contact DRI by writing to Digital Research Inc., P.O. Box 579, Pacific Grove, California 93950.

THIS AGREEMENT CANNOT AND SHALL NOT BE MODIFIED BY PURCHASE ORDERS, ADVERTISING OR OTHER REPRESENTATIONS BY ANYONE, AND MAY ONLY BE MODIFIED BY A WRITTEN AMENDMENT EXECUTED BY YOU AND AN AUTHORISED OFFICER OF DRI AND AMSTRAD.

YOU ACKNOWLEDGE THAT YOU HAVE READ THIS AGREEMENT, UNDERSTAND IT AND AGREE TO BE BOUND BY ITS TERMS AND CONDITIONS. YOU FURTHER AGREE THAT IT IS THE COMPLETE AND EXCLUSIVE STATEMENT OF THE AGREEMENT BETWEEN YOU AND DRI AND AMSTRAD WHICH SUPERSEDES ANY PROPOSAL OR PRIOR AGREEMENT, ORAL OR WRITTEN, AND ANY COMMUNICATIONS BETWEEN YOU AND DRI OR AMSTRAD RELATING TO THE SUBJECT MATTER OF THIS AGREEMENT.

THIS AGREEMENT DOES NOT AFFECT YOUR STATUTORY RIGHTS.

Important Notice

THE SOFTWARE CONTAINED IN THE DISKETTE PACKAGE IS SUPPLIED TO YOU ON THE TERMS AND CONDITIONS INDICATED BELOW. THE OPENING OF THIS PACKAGE INDICATES YOUR ACCEPTANCE OF THESE TERMS AND CONDITIONS. IF SUCH TERMS AND CONDITIONS ARE NOT ACCEPTED BY YOU, YOU MUST RETURN THE UNOPENED PACKAGE TO THE PLACE OF PURCHASE AND YOUR MONEY WILL BE REFUNDED. NO REFUNDS WILL BE GIVEN WHERE THE PACKAGE HAS BEEN OPENED UNLESS THE PRODUCT IS FAULTY AND SUCH REFUND BECOMES PAYABLE UNDER CLAUSE 7 BELOW

In this notice, the terms:

"Locomotive" means Locomotive Software Limited

"Amstrad" means Amstrad Consumer Electronics plc

"The Program" means the program known as BASIC.COM on Side 2 of the diskettes supplied in the diskette package.

1. Copyright

Material within the Program is copyright Locomotive. Locomotive grants to the purchaser of this package a non-exclusive right to use The Program in accordance with these terms and conditions. Such Licence may be transferred only in accordance with Clause 3 below. Any other use or dealing not expressly authorised by these terms and conditions is strictly prohibited.

2. Use

The Program may only be used on a single machine or terminal at any one time but may be copied or merged into other programs in support of that use. Any such copying or merger is subject to there being no modification of The Program and in particular to the copyright notice of Locomotive being preserved in the copied or combined program. Save for copying or merger within other programs as aforesaid, any other operations (including modification or translation from machine readable form) are expressly prohibited.

3. Transfer

The Program may be transferred to a third party provided the original Program and all copies are transferred or otherwise destroyed and provided further these terms and conditions are produced to that third party and prior to the transfer that party agrees and undertakes to observe and continue to observe the same. Without such transfer and undertaking any application of The Program or copies thereof by any other person will not be authorised by Locomotive and will be in breach of Locomotive's copyright and other proprietary rights.

4. Documentation

The documentation accompanying The Program is also copyright Locomotive. However, no right to reproduce that documentation in part or in whole is granted by Locomotive. Should additional copies of the documentation be required for whatever reason, application must be made in writing to Locomotive which will be considered in its discretion.

5. Breach

If the user for the time being acts in breach of any of these terms and conditions it shall indemnify Locomotive against all loss suffered (including loss of profits) and the licence granted hereunder shall be deemed to be terminated forthwith. On termination the user shall deliver up to Locomotive all infringing and lawful copies of The Program.

6. Exclusions

Neither Locomotive nor any person authorised by it gives warranties or makes representations that the program is error free or will meet functions required by the user. It shall be the responsibility of the user to satisfy itself that The Program meets the user's requirements. The program is supplied on an "as is" basis and save as expressly provided in these conditions all warranties of any nature (and whether express or implied) are excluded.

7. Liability

Amstrad warrants that the diskette on which the program is stored is free from material defect and through normal use will remain so for a period of 90 days after purchase. In the event of any breach of this warranty (or statutory warranty or conditions incapable of exclusion by these conditions) the responsibilities of Amstrad shall be limited to replacing the enclosed program or to returning the price paid for the same as they shall determine.

As the sole exception to the foregoing Locomotive will accept liability for death or personal injury resulting from its negligence. In no circumstance shall Locomotive be liable for any indirect or consequential costs damages or losses (including loss of business profits, operating time or otherwise) arising out of the use or inability to use the enclosed program and diskette and whether or not the likelihood of damage was advised to Locomotive or its dealer.

This notice does not affect your statutory rights.
